

DSX-600

CableAnalyzer™

Technical Reference Handbook

Software Version 5.2

May 2017, Rev. 1 8/2017

©2017 Fluke Corporation

All product names are trademarks of their respective companies.

LIMITED WARRANTY AND LIMITATION OF LIABILITY

Each Fluke Networks product is warranted to be free from defects in material and workmanship under normal use and service unless stated otherwise herein. The warranty period for the mainframe is one year and begins on the date of purchase. Parts, accessories, product repairs and services are warranted for 90 days, unless otherwise stated. Ni-Cad, Ni-MH and Li-Ion batteries, cables or other peripherals are all considered parts or accessories. The warranty extends only to the original buyer or end user customer of a Fluke Networks authorized reseller, and does not apply to any product which, in Fluke Networks' opinion, has been misused, abused, altered, neglected, contaminated, or damaged by accident or abnormal conditions of operation or handling. Fluke Networks warrants that software will operate substantially in accordance with its functional specifications for 90 days and that it has been properly recorded on non-defective media. Fluke Networks does not warrant that software will be error free or operate without interruption.

Fluke Networks authorized resellers shall extend this warranty on new and unused products to end-user customers only but have no authority to extend a greater or different warranty on behalf of Fluke Networks. Warranty support is available only if product is purchased through a Fluke Networks authorized sales outlet or Buyer has paid the applicable international price. To the extent permitted by law, Fluke Networks reserves the right to invoice Buyer for repair/replacement when a product purchased in one country is submitted for repair in another country.

For a list of authorized resellers, visit www.flukenetworks.com/wheretobuy.

Fluke Networks warranty obligation is limited, at Fluke Networks option, to refund of the purchase price, free of charge repair, or replacement of a defective product which is returned to a Fluke Networks authorized service center within the warranty period.

To obtain warranty service, contact your nearest Fluke Networks authorized service center to obtain return authorization information, then send the product to that service center, with a description of the difficulty, postage and insurance prepaid (FOB destination). Fluke Networks assumes no risk for damage in transit. Following warranty repair, the product will be returned to Buyer, transportation prepaid (FOB destination). If Fluke Networks determines that failure was caused by neglect, misuse, contamination, alteration, accident or abnormal condition of operation or handling, or normal wear and tear of mechanical components, Fluke Networks will provide an estimate of repair costs and obtain authorization before commencing the work. Following repair, the product will be returned to the Buyer transportation prepaid and the Buyer will be billed for the repair and return transportation charges (FOB Shipping point).

THIS WARRANTY IS BUYER'S SOLE AND EXCLUSIVE REMEDY AND IS IN LIEU OF ALL OTHER WARRANTIES, EXPRESS OR IMPLIED, INCLUDING BUT NOT LIMITED TO ANY IMPLIED WARRANTY OF MERCHANTABILITY OR FITNESS FOR A PARTICULAR PURPOSE. FLUKE NETWORKS SHALL NOT BE LIABLE FOR ANY SPECIAL, INDIRECT, INCIDENTAL OR CONSEQUENTIAL DAMAGES OR LOSSES, INCLUDING LOSS OF DATA, ARISING FROM ANY CAUSE OR THEORY.

Since some countries or states do not allow limitation of the term of an implied warranty, or exclusion or limitation of incidental or consequential damages, the limitations and exclusions of this warranty may not apply to every buyer. If any provision of this Warranty is held invalid or unenforceable by a court or other decision-maker of competent jurisdiction, such holding will not affect the validity or enforceability of any other provision.

Contents

Chapter 1 Get Acquainted

Overview of Features	1
Contact Fluke Networks	2
Register Your Product	2
Additional Resources	2
Supplements and Updated Manuals	2
Symbols	3
 Safety Information	4
Connectors, Keys, and LEDs	8
About Link Interface Adapters	12
How to Prevent Damage to the Adapter Cables	12
About the Optional DSX-PLA001 Adapter Modules	14
AC Adapter and Battery	16
Charge the Battery	16
Check the Battery Status	17
Verify Operation	19
How to Use the Touchscreen	19
How to Enter Text	22
Set User Preferences	24
Language	24
Date and Time Settings and Formats	24
Number Format	25
Units for Length Measurements	25
Power-Down and Backlight Timeout Periods	25

Audible Tone	26
Power Line Frequency	26
Display Brightness	26
Import User Preferences from a File	27
Overview of Memory Functions	27
How to Install a Strap	28
About LinkWare Applications	29
LinkWare PC Cable Test Management Software ...	29
The LinkWare Live Web Application	29
LinkWare Stats	29

Chapter 2 Get Started

Tutorial: Certify Twisted Pair Cabling	31
Step 1: See How Much Memory is Available	32
Step 2: Set Up a Twisted Pair Test	32
Step 3: Turn Off the Auto Save Function	34
Step 4: Do an Autotest	34
Step 5: Look at the Results	34
Step 6: Save the Results	36
Buttons to Do Tests and Save Results	36
Options for Cable IDs	38
Automatic Increment Function for Cable IDs	39
Auto Save Function	39
Tutorial: Make a Set of Sequential Cable IDs	40
About Projects	41

Chapter 3 Certify Twisted Pair Cabling

The DSX-600 CableAnalyzer Home Screen	43
Make Sure Your Tester is Ready to Certify Twisted Pair Cabling	47

Set the Reference	48
Settings for Twisted Pair Tests	49
How to Do an Autotest	54
“Bad Patch Cord” Message	57
Twisted Pair Autotest Results	58
PASS*/FAIL* Results	58
WIRE MAP Tab	59
PERFORMANCE Tab	64
Scalar Results	65
Length, Propagation Delay, and Delay Skew....	65
Loop Resistance	67
Continuous Tests	70
Frequency-Domain Results	70
How to Save Frequency-Domain Results as a Plot or a Table	70
Insertion Loss	74
Return Loss	76
Impedance	78
NEXT (Near-End Crosstalk)	79
PS NEXT (Power Sum Near End Crosstalk)	81
ACR-N (Attenuation to Crosstalk Ratio at the Near End)	82
PS ACR-N (Power Sum Attenuation to Crosstalk Ratio, Near End)	84
ACR-F (Attenuation to Crosstalk Ratio, Far End)....	86
PS ACR-F	88
DIAGNOSTIC Tab	89
About dB Rules	90
3 dB Rule	92
4 dB Rule	92

12 dB Rule	92
67 dB Rule for ACR-F and PS ACR-F	92
70 dB Rule for ACR-F and PS ACR-F	92
How to Use the Tone Generator	94
How to Use the Talk Function	95

Chapter 4 Test Twisted Pair Through a PoE Device

How to Turn On the AC Wire Map Test	97
When to Keep the AC Wire Map Test Off	97
How to Do an Autotest Through a PoE Device	98
AC Wire Map Results	100

Chapter 5 Certify Coaxial Cabling

Set the Reference for Coaxial Tests	103
Settings for Coaxial Tests	105
How to Do an Autotest	107
Coaxial Autotest Results	110
Length and Propagation Delay	112
Resistance	113
Impedance	114
Insertion Loss	116
About Splitters	117
Tests Without a Remote	117
Continuous Tests	120

Chapter 6 Diagnose Copper Test Failures

Causes of Twisted Pair Test Failures	121
Causes of Coaxial Test Failures	125
The HDTDR Analyzer	127
The HDTDX Analyzer	133

How to Use the Measurement Cursor on the
HDTDR and HDTDx Plot 137

Chapter 7 Manage Test Results

View Saved Results 141
 How to Replace a Saved Result that Failed 144
 Delete, Rename, and Move Results 144
 Manage Results on a Flash Drive 146
 Upload Results to a PC 147
 About LinkWare Live 148
 View the Memory Status 149

Chapter 8 Use Projects

Why Use Projects? 151
 Tutorial: Make a New Project 152
 Step 1: Give the Project a Name 154
 Step 2: Specify an Operator 154
 Step 3: Set up Tests for the Project 155
 To set up a twisted pair test for the
 project 155
 Step 4: Make ID Sets 156
 To see the CABLE ID SETUP screen 156
 To make a cable ID set 156
 Step 5: Turn on the Auto Save Function 159
 Tutorial: How to Use a Project for Tests 160
 Step 1: Select a Project 160
 Step 2: Select a Test for Twisted Pair Cable 160
 Step 3: Do an Autotest 162
 Step 4: Monitor the Status of Your Project 162
 How to Change Settings as You Use a Project 162

To Change the ID	162
To use a different, unused ID from an ID set that has a first and last ID	162
To use an ID you used before	163
To use an ID that is not in an ID set that has a first and last ID	163
To change the ID when the set has only a next ID	164
To Change the Tests in a Project	164
To Select a Different Test in the Project	165
To Add a Test to a Project	165
To Save Results in a Different or New Project	165
How to Make ID Sets	165
If an ID Sequence is Invalid	167
About Next ID Sets	168
Import an ID Set into a Project	169
Delete an Imported ID Set	169
How to Manage Projects	170
View Results in a Project	170
Rename a Project	170
Copy a Project to Make a New Project	170
Delete a Project	171
Manage Projects on a Flash Drive	171
Copy Project Settings to Other Testers	172
About LinkWare Live	172

Chapter 9 **Sync Projects with LinkWare™ Live**

Sign Up for a LinkWare Live Account	173
How to See the Tester's MAC Address	174

Use LinkWare Live Through a Wired Ethernet Network	174
Use LinkWare Live Through a Wi-Fi Ethernet Network	175
Change the Network Settings	178
Settings for the Wired Port	178
Settings for the Wi-Fi Port	179
Delete Wi-Fi Settings and Passwords	179
About the Asset Management Service	179
Sign Your Tester Out of LinkWare Live	179
Sign In to LinkWare Live from a Desktop or Mobile Device	181
Import Projects from LinkWare Live into LinkWare PC	181
For More Information on LinkWare Live	181

Chapter 10 Custom Media and Test Limits

Make a Custom Copper Cable Type	183
Change the NVP	184
Set the NVP to a Specified Value	184
Find a Cable's Actual NVP	185
Reset the NVP to the Default Value	186
Make a Custom Outlet Configuration	186

Chapter 11 Maintenance

Verify Operation	189
Clean the Tester	190
See Information About the Tester	190
Update the Software	192
Use a PC to Update the Software	193

Use an Updated Main Tester to Update Other Testers	194
Use LinkWare Live to Update the Software	196
Extend the Life of the Battery	197
Store the Tester	197
Remove the Battery	197
Replace the Tip on a DSX-PLA004 Connector	198
Traceable Calibration Period	199
Options and Accessories	200
If the Tester Does Not Operate as Usual	200

Chapter 12 Specifications

Environmental and Regulatory Specifications	203
Performance Specifications	204
Times for a Full, 2-Way Autotest	204
Tests and Frequencies Supported	205
Twisted Pair Cabling	205
Coaxial Cabling (optional DSX-CHA003 coaxial adapters required)	205
Standard Link Interface Adapters	205
DSX-CHA004 Class E _A Channel Adapters	205
DSX-PLA004 Class E _A Permanent Link Adapters	205
Measurement Accuracy	206
Length of Twisted Pair Cabling	208
Propagation Delay	209
Delay Skew	209
DC Loop Resistance	209
HDTDX Analyzer Specifications for Cables <100 m (328 ft)	209

HDTDR Analyzer Specifications for Cables <100 m (328 ft)	210
Characteristic Impedance	210
Tone Generator	210
Input Protection	211
Power	211
Traceable Calibration Period	211
DSX-CHA003 Coaxial Adapter	212
Internal Memory for Test Results	213
USB Flash Drive	213
Serial Interfaces	213
RJ45 Connector on the Main Unit	213
Headset Jack	213
Display	214
Weights	214
Dimensions	214

List of Figures

Figure		Page
1.	Main Tester Connectors, Keys, and LEDs	8
2.	Remote Tester Connectors, Keys, and LEDs.....	10
3.	How to Attach and Remove Link Interface Adapters	12
4.	How to Prevent Damage to the Permanent Link Adapter Cables.....	13
5.	How to Change the Personality Module on an Optional DSX-PLA001 Adapter.....	15
6.	LEDs Show the Remote's Battery Status	17
7.	Connections to See the Status of the Remote's Battery	18
8.	How to Zoom the Screen	21
9.	The Keyboards for Text Entry.....	23
10.	How to Install a Strap and Use the Optional Hand Strap.....	28
11.	Equipment for the Twisted Pair Certification Tutorial	31
12.	Examples of Twisted Pair Autotest Results Screens	35
13.	FIX LATER, TEST AGAIN, and TEST Buttons and the TEST Key.....	36
14.	The Home Screen for DSX-600 CableAnalyzer	44
15.	Reference Connections for Twisted Pair Cable	49
16.	Outlet Configurations.....	53
17.	Equipment for Autotests on Twisted Pair Cable	54
18.	Permanent Link Connections.....	56
19.	Channel Connections	57
20.	PASS* and FAIL* Results	59
21.	WIRE MAP Tab.....	60

22.	Wire Map Examples: Open Wire and Open Shield	61
23.	Wire Map Examples: Short and Split Pair	62
24.	Wire Map Examples: Reversed Pair and Crossed Pairs.....	63
25.	PERFORMANCE Tab	64
26.	Twisted Pair Length Results	67
27.	Twisted Pair Resistance Results	69
28.	Plot Screen for a Frequency-Domain Test	71
29.	Tabular Results Screen for a Frequency-Domain Test	73
30.	Insertion Loss is a Decrease in Signal Strength	75
31.	Twisted Pair Insertion Loss Plot	75
32.	Sources of Return Loss.....	77
33.	Return Loss Plot	77
34.	Twisted Pair Impedance Results.....	78
35.	Near-End Crosstalk (NEXT)	79
36.	NEXT Plot	80
37.	PS NEXT Plot.....	81
38.	Attenuation to Crosstalk Ratio, Near End (ACR-N).....	82
39.	ACR-N Plot.....	83
40.	PS ACR-N Plot.....	85
41.	Far-End Crosstalk (FEXT).....	86
42.	ACR-F Plot	87
43.	PS ACR-F Plot.....	88
44.	Examples of Diagnostic Screens	89
45.	How the 3 dB Rule Shows on Plots.....	91
46.	How to Use the Tone Generator	95
47.	Permanent Link Connections Through a PoE Device.....	99
48.	Channel Connections Through a PoE Device	100
49.	AC Wire Map Examples: Open and Short.....	101
50.	AC Wire Map Examples:	102

51.	Reference Connections for Tests on Coaxial Cabling.....	104
52.	Equipment for Tests on Coaxial Cabling.....	108
53.	Examples of Connections for Tests on Coaxial Cabling	109
54.	Autotest Results for Coaxial Cabling	110
55.	Coaxial Length and Propagation Delay Results	112
56.	Coaxial Resistance Results.....	113
57.	Coaxial Impedance Results	115
58.	Coaxial Insertion Loss Results	116
59.	Connections for Coaxial Tests Without a Remote.....	119
60.	HDTDR Plot for Twisted Pair Cable	128
61.	Common Faults Shown on HDTDR Plots.....	130
62.	HDTDR Plot for Coaxial Cable	131
63.	HDTDX Plot.....	134
64.	Typical Faults Shown on HDTDX Plots	136
65.	How to Use the Measurement Cursor on the HDTDR or HDTDX Plot	138
66.	RESULTS Screen	142
67.	How to Connect the Tester to a PC.....	148
68.	PROJECT Screen	152
69.	CHANGE CABLE IDs Screen	157
70.	CABLE ID SETUP Screen (after you enter the first and last IDs)	158
71.	Equipment for the Twisted Pair Project Tutorial	160
72.	CHANGE TEST Screen	161
73.	SYNC PROJECTS Screen	177
74.	VERSION INFORMATION Screen for the Main Tester.....	191
75.	How to Connect the Tester to a PC.....	194
76.	How to Connect Testers Together to Update the Software	195
77.	How to Remove the Battery.....	198

78. How to Replace the DSX-PLA004 Adapter’s Tip and Latch 199

79. Plug for the Headset Jack 214

List of Tables

Table		Page
1.	Symbols	3
2.	Settings for Twisted Pair Tests.....	50
3.	dB Rules for TIA Test Limits	93
4.	dB Rules for ISO Test Limits	93
5.	Settings for Coaxial Tests.....	106
6.	Remote Requirements for Coaxial Tests	118
7.	Causes of Twisted Pair Test Failures	121
8.	Causes of Coaxial Test Failures	125
9.	Settings for the Wi-Fi Connection.....	180
10.	Possible Solutions for Unusual Behavior	200

Chapter 1: Get Acquainted

Overview of Features

The DSX-600 CableAnalyzer main and remote units are rugged, hand-held instruments that you configure to certify, troubleshoot, and document copper cabling. The DSX-600 includes these features:

- The testers certify twisted pair cabling to Cat 6A/Class E_A limits (500 MHz) in less than 10 seconds.
- Gives a PASS or FAIL result based on a test limit that you specify.
- You can save approximately 12,700 Cat 6A Autotest results, with plot data, in the tester's internal memory. You can save more results on a removable flash drive.
- Taptive™ user interface lets you quickly navigate through different views of the results and see more information about cables.
- ProjX™ management system lets you set up projects to specify the types of tests and the cable IDs necessary for a job and monitor the progress and status of the job.
- You can connect the tester to a wired or Wi-Fi network and use the LinkWare™ Live web application to manage your projects from a desktop or mobile device.
- LinkWare PC software lets you upload test results to a PC and make professional-quality test reports.
- LinkWare Stats software makes browsable, graphical reports of cable test statistics.

Contact Fluke Networks



www.flukenetworks.com/support



info@flukenetworks.com



1-800-283-5853, +1-425-446-5500



Fluke Networks
6920 Seaway Boulevard, MS 143F
Everett WA 98203 USA

Fluke Networks operates in more than 50 countries worldwide.
For more contact information, go to our website.

Register Your Product

Registering your product with Fluke Networks gives you access to valuable information on product updates, troubleshooting tips, and other support services. If you purchased a Gold Support plan, registration also activates your plan.

To register your product, use LinkWare PC software.

Additional Resources

The Fluke Networks Knowledge Base answers common questions about Fluke Networks products and provides articles on cable testing techniques and technology.

To access the Knowledge Base, log on to www.flukenetworks.com, then click **SUPPORT > Knowledge Base**.

Supplements and Updated Manuals

If necessary, Fluke Networks will put a supplement for this manual, or an updated manual, on the Fluke Networks website. To see if a supplement or updated manual is available, log on to www.flukenetworks.com, click **SUPPORT > Manuals**, then select a product.

Symbols

Table 1 shows the symbols used on the tester or in this manual.

Table 1. Symbols















	Warning: Risk of fire, electric shock, or personal injury.
	Warning or Caution: Risk of damage or destruction to equipment or software. See explanations in the manuals.
	Consult the user documentation.
	Do not connect this equipment to public communications networks, such as telephone systems.
	This product complies with the WEEE Directive marking requirements. The affixed label indicates that you must not discard this electrical/electronic product in domestic household waste. Product Category: With reference to the equipment types in the WEEE Directive Annex I, this product is classed as category 9 "Monitoring and Control Instrumentation" product. Do not dispose of this product as unsorted municipal waste. To return unwanted products, contact the manufacturer's web site shown on the product or your local sales office or distributor.
	This Product contains a lithium-ion battery. Do not mix with the solid waste stream. Spent batteries should be disposed of by a qualified recycler or hazardous materials handler per local regulations. Contact your authorized Fluke Service Center for recycling information.
	Complies with California Energy Commission (CEC) requirements for battery charger systems.
	Conformite Europeene. Conforms to requirements of European Union directives. Safety requirements for electrical equipment for measurement, control, and laboratory use.
	Conforms to relevant North American standards.
	Conforms to relevant Australian standards.

Table 1. Symbols (continued)

	40 year Environment Friendly Use Period (EFUP) under China Regulation - Administrative Measure on the Control of Pollution Caused by Electronic Information Products. This is the period of time before any of the identified hazardous substances are likely to leak out, causing possible harm to health and the environment.
	Conforms to relevant Russian standards.
	KCC-REM-FKN-012001001: EMC approval for Korea Class A Equipment (Industrial Broadcasting & Communication Equipment) This product meets requirements for industrial (Class A) electromagnetic wave equipment and the seller or user should take notice of it. This equipment is intended for use in business environments and is not to be used in homes.
	This key turns the tester on and off.

Safety Information

Warning

To prevent possible fire, electric shock, or personal injury:

- **Read all safety information before you use the Product.**
- **Carefully read all instructions.**
- **Do not open the case. You cannot repair or replace parts in the case.**
- **Do not modify the Product.**
- **Use only replacement parts that are approved by Fluke Networks.**
- **Do not touch voltages > 30 V AC rms, 42 V AC peak, or 60 V DC.**

- Do not use the Product around explosive gas, vapor, or in damp or wet environments.
- Use this Product indoors only.
- Use the Product only as specified, or the protection supplied by the Product can be compromised.
- Do not use and disable the Product if it is damaged.
- Do not use the Product if it operates incorrectly.
- Do not connect the tester to telephony inputs, systems, or equipment, including ISDN inputs. Doing so is a misapplication of this product, which can cause damage to the tester and make a possible shock hazard for the user.
- Always turn on the tester before you connect it to a link. Doing so activates the tester's input protection circuitry.
- Do not operate the Product with covers removed or the case open. Hazardous voltage exposure is possible.
- Remove the input signals before you clean the Product.
- Do not put metal objects into connectors.
- Batteries contain hazardous chemicals that can cause burns or explode. If exposure to chemicals occurs, clean with water and get medical aid.
- Remove the batteries if the Product is not used for an extended period of time, or if stored in temperatures above 50 °C. If the batteries are not removed, battery leakage can damage the Product.
- Replace the rechargeable battery after 5 years of moderate use or 2 years of heavy use. Moderate use is defined as recharged twice a week. Heavy use is defined as discharged to cutoff and recharged daily.
- Disconnect the battery charger and move the Product or battery to a cool, non-flammable location

if the rechargeable battery becomes hot (>50 °C, >122 °F) during the charge period. The battery door must be closed and locked before you operate the Product.

- The battery door must be closed and locked before you operate the Product.
- Repair the Product before use if the battery leaks.
- Recharge the batteries when the low battery indicator shows to prevent incorrect measurements.
- Turn off the Product and disconnect all test leads, patch cords, and cables before you replace the battery.
- Do not disassemble or crush battery cells and battery packs.
- Do not put battery cells and battery packs near heat or fire. Do not put in direct sunlight.
- Have an approved technician repair the Product.
- Use only AC adapters approved by Fluke Networks for use with the Product to supply power to the Product and charge the battery.

 **Caution**

To prevent damage to the tester or cables under test, to prevent data loss, and to make sure your test results are as accurate as possible:

- Do not connect the tester to an active network. Doing so causes unreliable test results, can disrupt network operations, and can cause damage to the tester.
- Connect only RJ45 plugs to the adapters. Other types of plugs, such as RJ11 (telephone) plugs, can cause permanent damage to the jacks.

- To make sure your test results are as accurate as possible, do the reference procedure every 30 days. See “Set the Reference” on page 48.
- Do not operate portable transmitting devices, such as walkie-talkies and cell phones, during a cable test. Doing so can cause errors in test results.
- For permanent link adapters, do not twist, pull on, pinch, crush, or make kinks in the cables. See Figure 4 on page 13.
- Do not remove the USB flash drive while the LED on the drive flashes. Doing so can corrupt the data on the drive.
- You can lose a USB flash drive, cause damage to it, or accidentally erase the contents of the drive. Thus, Fluke Networks recommends that you save no more than one day of test results on a flash drive, or that you upload results to LinkWare Live. See Chapter 9.

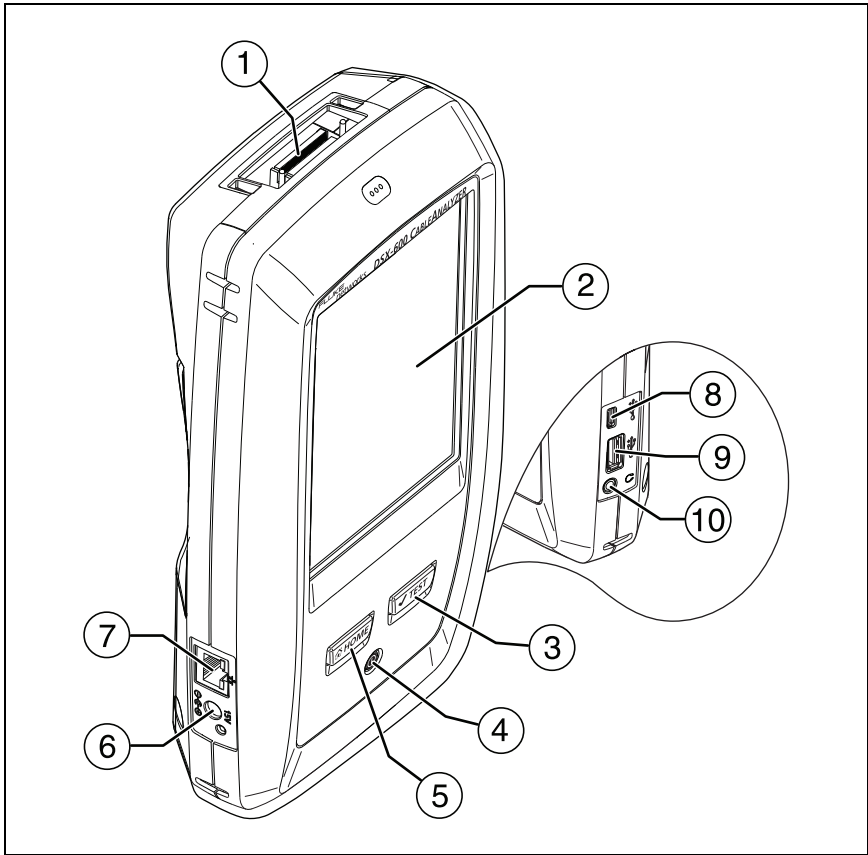

Connectors, Keys, and LEDs



BA88.EPS

Figure 1. Main Tester Connectors, Keys, and LEDs

- ① Connector for a link interface adapter
- ② LCD display with touchscreen
- ③ TEST: Starts a test. To start a test, you can also tap TEST on the display. The tone generator turns on if a remote tester is not connected to the main tester. See “How to Use the Tone Generator” on page 94.

- ④ : Power key
- ⑤ : Press  to go to the home screen.
- ⑥ Connector for the AC adapter. The LED is red when the battery charges, and green when the battery is fully charged. The LED is yellow if the battery will not charge. See “Charge the Battery” on page 16.
- ⑦ RJ45 connector: Lets you connect to a network for access to Fluke Networks cloud services.
- ⑧ Micro-AB USB port: This USB port lets you connect the tester to a PC so you can upload test results to the PC and install software updates in the tester.
- ⑨ Type A USB port: This USB host port lets you save test results on a USB flash drive, connect the FI-1000 video probe to the tester, and connect a Wi-Fi adapter for access to Fluke Networks cloud services.
- ⑩ Headset jack. See “How to Use the Talk Function” on page 95.

Note

*If you have two main testers, you can use one as a remote. To select the remote function, tap **TOOLS** > **Main as Remote**.*

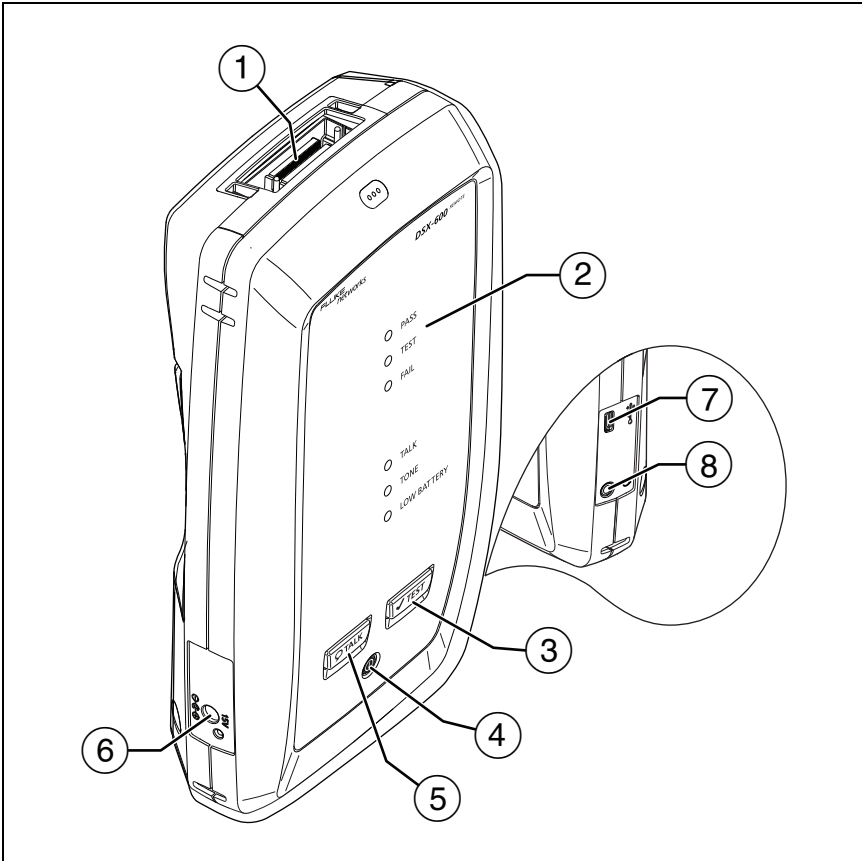

BA42.EPS

Figure 2. Remote Tester Connectors, Keys, and LEDs

- ① Connector for a link interface adapter

- ② **PASS** LED comes on when a test passes.

TEST LED flashes during a test.

FAIL LED comes on when a test fails.

TALK LED comes on when the talk function is on (⑤). The LED flashes until the main tester accepts the request to talk. See “How to Use the Talk Function” on page 95.



TONE LED flashes and the tone generator comes on if you press TEST when a main tester is not connected to the remote. See “How to Use the Tone Generator” on page 94.

LOW BATTERY LED comes on when the battery is low. The LEDs also have these functions:

- Battery gauge (see Figure 6 on page 17)
- Volume indicator for the **TALK** function
- Progress indicator for software updates

- ③ TEST: Starts a test. Turns on the tone generator if a main tester is not connected to the remote. See “How to Use the Tone Generator” on page 94.

- ④ ①: Power key

- ⑤ TALK: Press TALK to use the headset to speak to the person at the other end of the link. See “How to Use the Talk Function” on page 95.

- ⑥ Connector for the AC adapter. The LED is red when the battery charges, and green when the battery is fully charged. The LED is yellow if the battery will not charge. See “Charge the Battery” on page 16.

- ⑦ Micro-AB USB port: This USB port lets you connect the tester to a PC so you can upload test results to the PC.

- ⑧ Headset jack. See “How to Use the Talk Function” on page 95.

About Link Interface Adapters

Link interface adapters let you connect the DSX CableAnalyzer to different types of twisted pair links. Figure 3 shows how to attach and remove adapters.

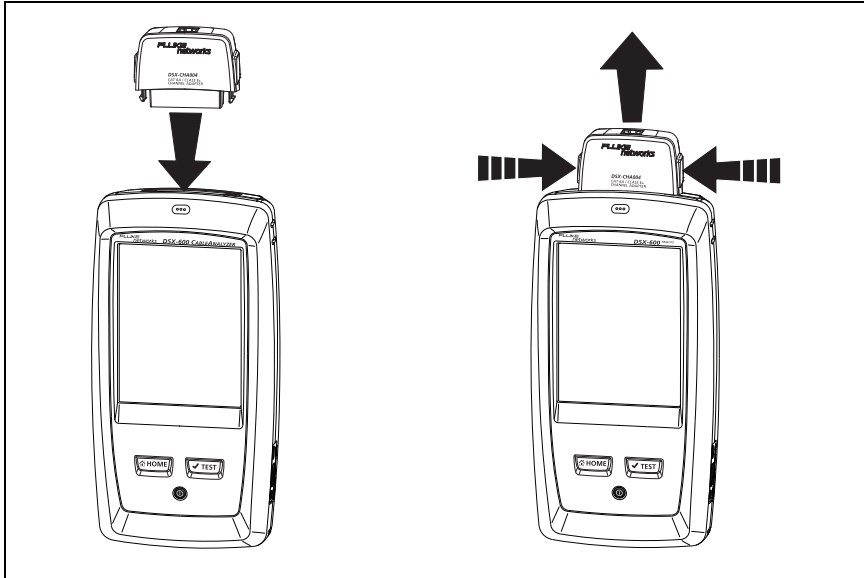

BA109.EPS

Figure 3. How to Attach and Remove Link Interface Adapters

How to Prevent Damage to the Adapter Cables

Caution

To prevent damage to the cables on the permanent link adapters and to make sure your test results are as accurate as possible, do not twist, pull on, pinch, crush, or make kinks in the cables. See Figure 4 on page 13.

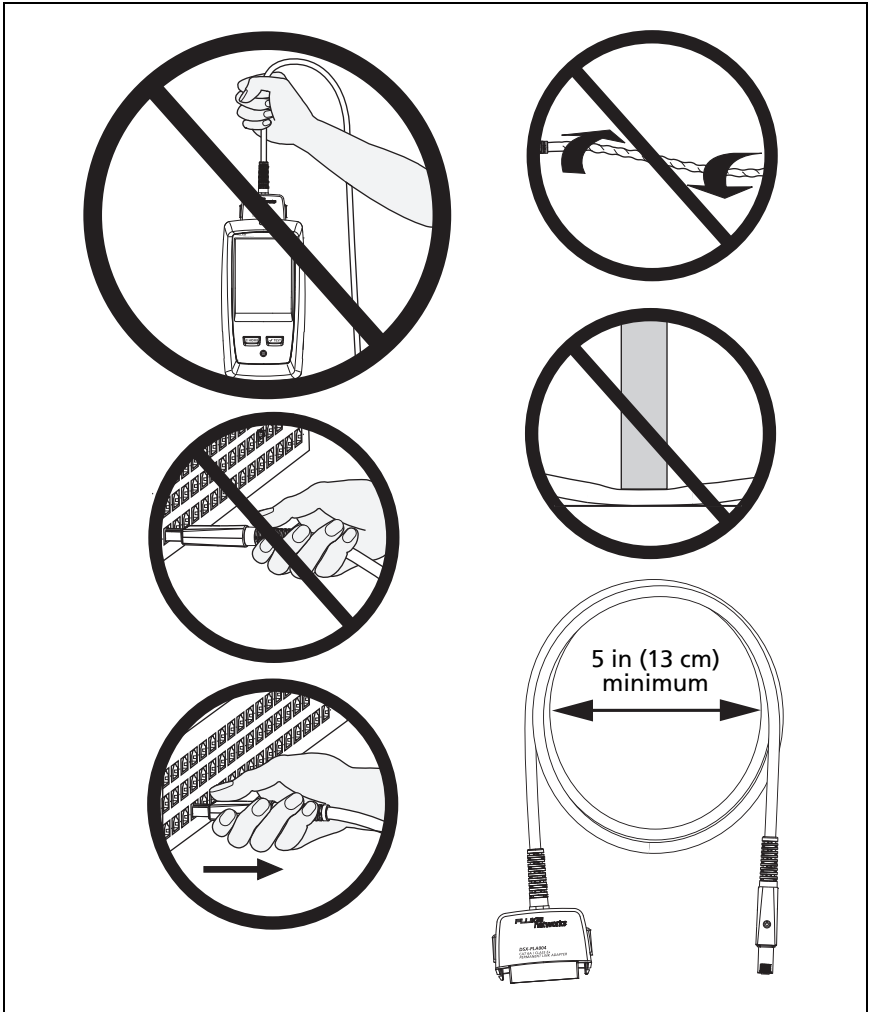

GPU108.EPS

Figure 4. How to Prevent Damage to the Permanent Link Adapter Cables

About the Optional DSX-PLA001 Adapter Modules

The optional DSX-PLA001 Universal Permanent Link Adapter has an interchangeable personality module. The module lets you connect the adapter to different styles of insulation displacement connectors (IDCs).

Figure 5 shows how to remove and install a personality module.



Caution

To prevent latent or immediate damage caused by electrostatic discharge and to prevent damage to the DSP-PMxx personality module and the socket on the cable:

- Before you touch a personality module or DSX-PLA001 permanent link adapter with no module attached, touch a grounded, conductive surface.
- Always remove the adapter from the tester before you change the personality module.
- Always keep a personality module attached to the adapter cable.
- Tighten the screw only with your fingers. Do not tighten too much. Do not use tools to tighten the screw.
- Do not touch the gold contacts on the socket or the module.
- Always keep unused personality modules in their original, static-protection bags.

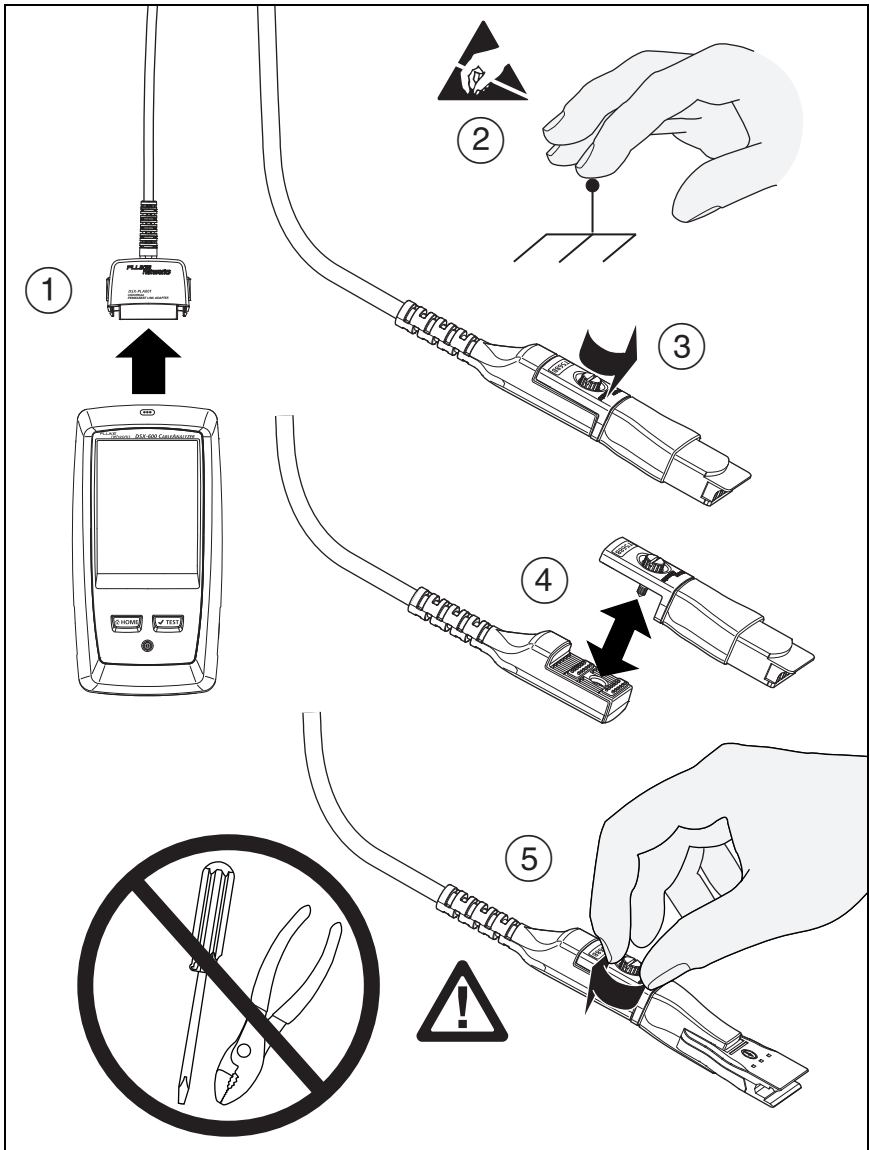

BA164.EPS

Figure 5. How to Change the Personality Module on an Optional DSX-PLA001 Adapter

AC Adapter and Battery

You can use the ac adapter (model PWR-SPLY-30W) or the lithium ion battery (model VERSIV-BATTERY) to supply power to the tester.

To remove the battery, see “Remove the Battery” on page 197.

Charge the Battery

Before you use the battery for the first time, charge the battery for about 2 hours with the tester turned off.

To charge the battery

Connect the ac adapter to the 15V jack on the left side of the tester. The LED near the ac adapter connector is red when the battery charges, and green when the battery is fully charged.

A fully-charged battery operates for approximately 8 hours of typical use. The battery takes approximately 4 hours to fully charge when the tester is turned off.

Notes



You do not need to fully discharge the battery before you recharge it.

The battery will not charge if its temperature is outside the range of 32 °F to 104 °F (0 °C to 40 °C). The LED near the connection for the ac adapter is yellow if the battery will not charge.

Check the Battery Status

On a main tester

The battery status icon is in the upper-left corner of the screen:

-  Battery is full.
-  Battery is approximately half full.
-  If the ac adapter is not connected, the red bar shows that the battery is very low. Connect the ac adapter to charge the battery and make sure the tester continues to operate.

The red bar also shows if the ac adapter is connected, but the battery is not installed.

On a remote

The LEDs show the battery status at the end of the power-up sequence, as shown in Figure 6.

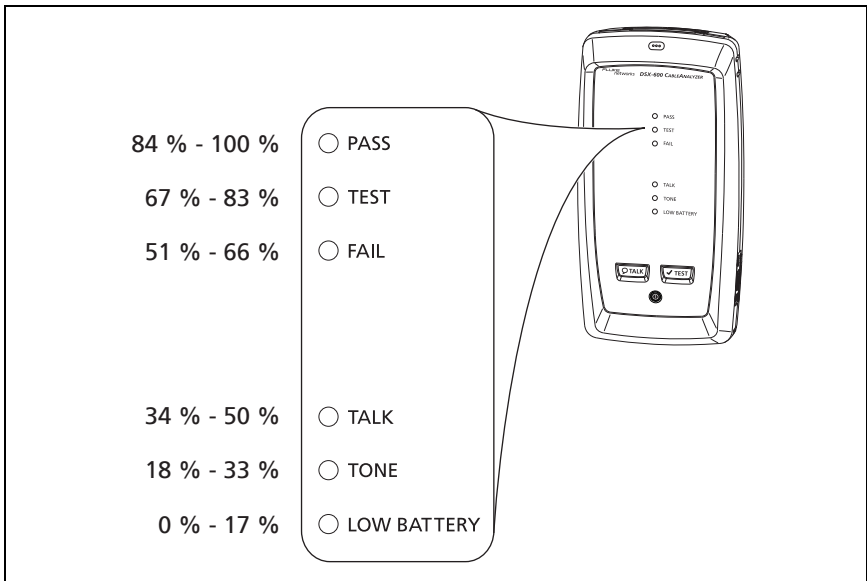



Figure 6. LEDs Show the Remote's Battery Status

BA102.EPS

To see more information about a remote's battery status

- 1 Make the connections shown in Figure 7 and turn on both testers.
- 2 Make sure the connection icon shows at the top of the screen ().
- 3 Tap **TOOLS**, then tap **Battery Status**.

When the ac adapter is not connected, the screen shows the **Time Remaining**, which is the approximate battery life at the present rate of use.

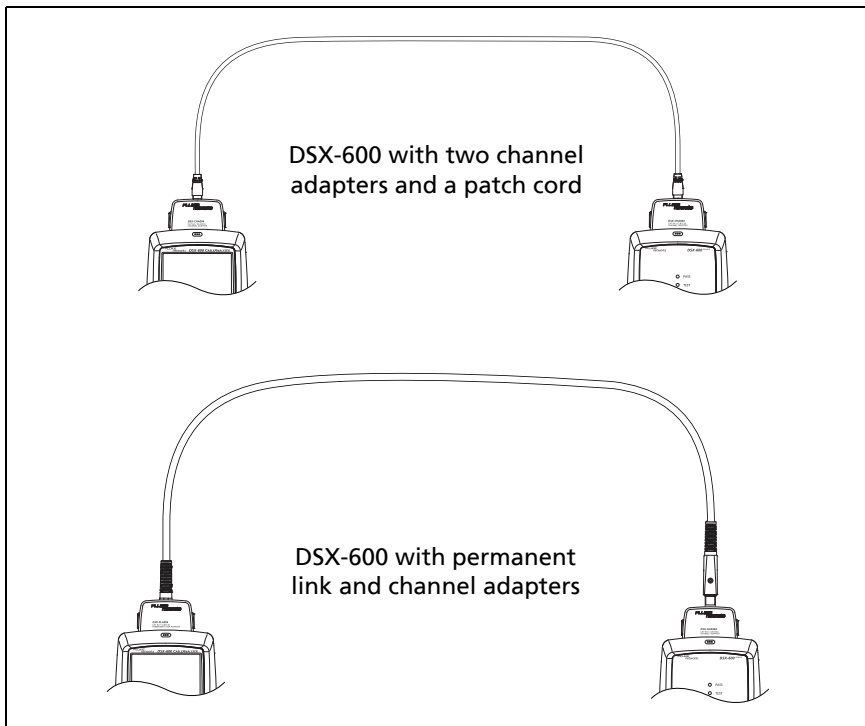

BA148.EPS

Figure 7. Connections to See the Status of the Remote's Battery

Verify Operation

The tester does a self test when you turn it on. If the tester shows an error or does not turn on, refer to “If the Tester Does Not Operate as Usual” on page 200.

How to Use the Touchscreen

The DSX-600 main unit’s Taptive user interface lets you use a touchscreen to control the tester. You can operate the touchscreen with your fingertip or with a stylus that is made for projected capacitance touchscreens.

Caution

For correct operation and to prevent damage to the touchscreen:

- **Touch the screen only with your fingers or with a stylus that is made for projected capacitance touchscreens. Do not use too much force.**
- **Do not touch the screen with sharp objects.**

Note

The touchscreen will not respond if you tap it with your fingernail or an incorrect type of stylus or if you wear non-conductive gloves.

To use the touchscreen

- To select an item on the screen, tap the item lightly with your fingertip.
- To scroll a screen, lightly touch the screen then move your fingertip in the direction you want the screen to move.
- On screens that show a plot, use the pinch and reverse-pinch gestures to change the magnification on the screen. See Figure 8.

When you zoom a plot, horizontal and vertical zoom controls show on the screen. These controls let you change the magnification on the distance and decibels scales independently.

You can zoom in to a maximum magnification factor of 128:1.

- On screens that show a plot, you can drag the measurement cursor.

To clean the touchscreen

Turn off the tester, then use a soft, lint-free cloth that is moist with a mild detergent.



When you clean the touchscreen, do not let liquid get under the plastic around the touchscreen.

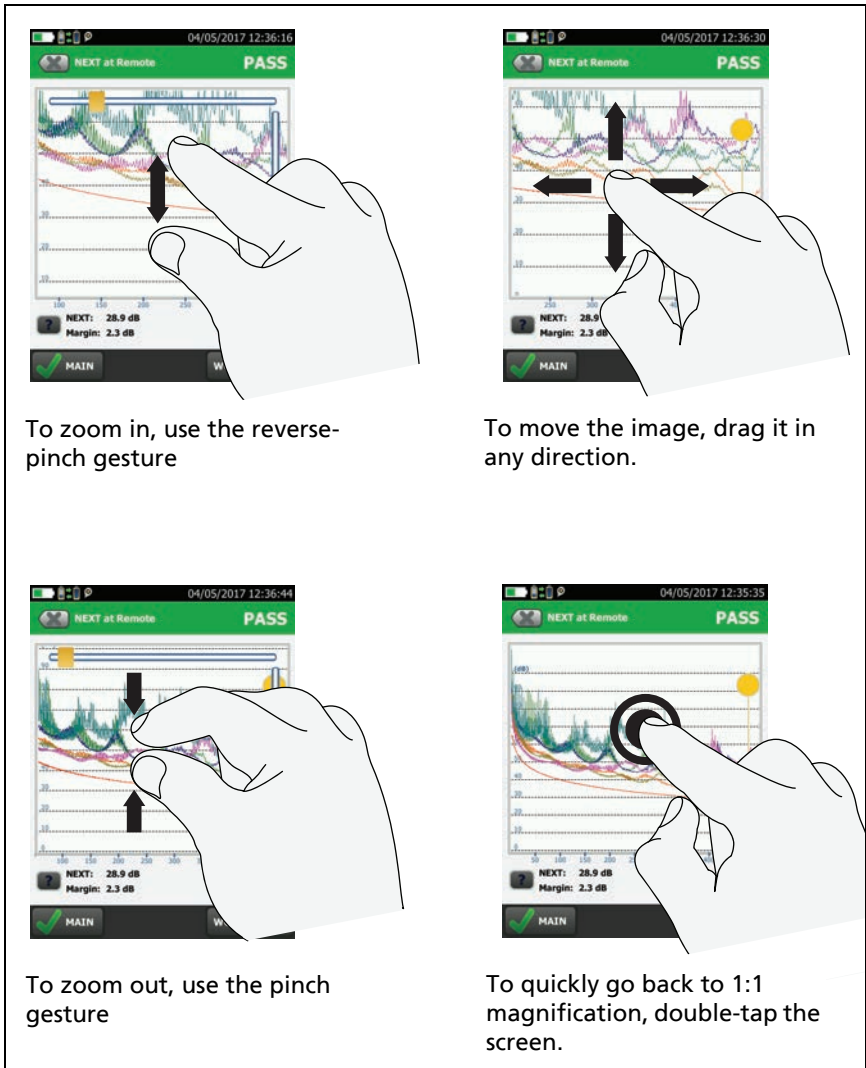





Figure 8. How to Zoom the Screen

BA45.eps

How to Enter Text

When you tap a panel to enter text, a keyboard shows on the bottom half of the display (Figure 9).

- To enter characters, tap the characters on the keyboard.
- To change the case of the letters, tap .
- To delete characters, tap .
- To move the cursor into a group of characters, tap on the group.
- To select a group of characters, double-tap on the group.
- To enter accented letters, tap , then tap the letters on the keyboard. To enter non-accented letters, tap  again.
- The keyboard you use to sign in to your LinkWare Live account includes symbols frequently used in web IDs and passwords.
- To save the text, tap **DONE**.

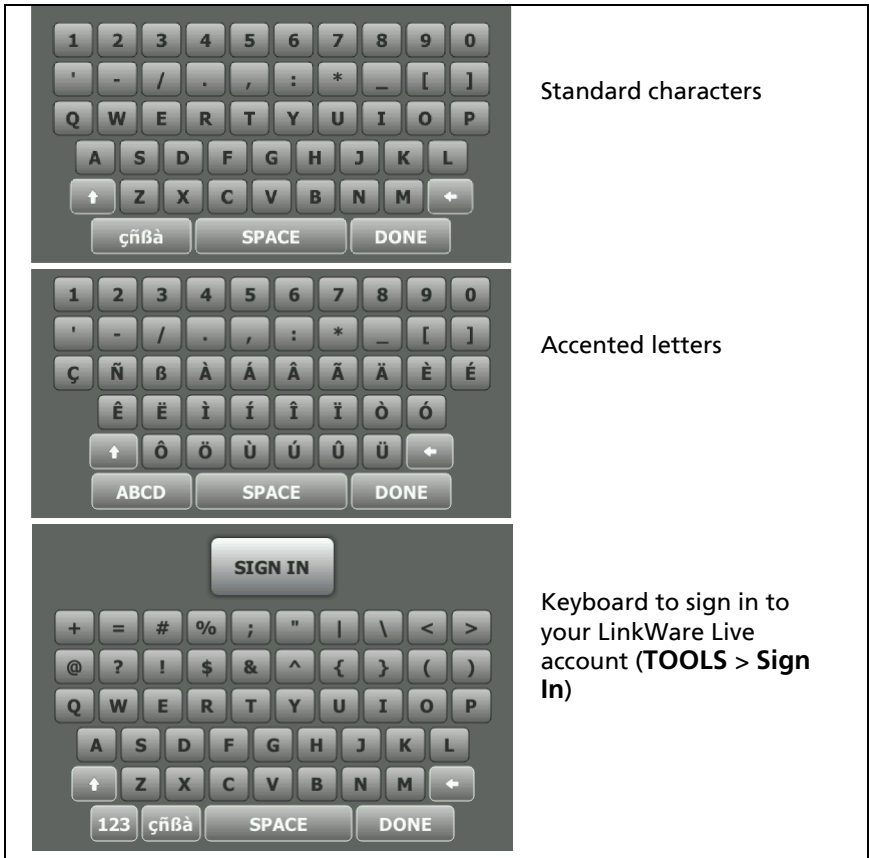

GPU28.EPS

Figure 9. The Keyboards for Text Entry

Set User Preferences

User preferences are settings you usually change when you use the tester for the first time.

Note

You can use LinkWare PC software to make a file that contains settings for user preferences, then you can install the settings in one or more testers. You can also export the settings from the tester to LinkWare PC. See "Import User Preferences from a File" on page 27. Also see the online help in LinkWare PC.





Language

On the home screen, tap the **TOOLS** icon, tap **Language**, then tap a language.

Date and Time Settings and Formats

Note



If you remove the battery and do not connect the ac adapter, the clock keeps the current date and time for a minimum of 24 hours.

- 1 On the home screen, tap the **TOOLS** icon, tap **Date/Time**, then tap the setting you want to change:
 - To set the date, tap **Date**. Tap  or  to select a month and year for the calendar, then tap the correct date on the calendar. Tap **DONE** to save your setting.
 - To set the time, tap **Time**. Tap  or  to increase or decrease the setting for hours, minutes, and seconds. Tap **DONE** to save your settings.
 - To set the date format, tap **Date Format**, then tap a format for the day (**DD**), month (**MM**), and year (**YYYY**).
 - To set the time format to 12-hour clock or a 24-hour clock, tap the **Time Format** control to make **12 hr** or **24 hr** show.



- 2 To go back to the home screen from the **Date/Time** screen, tap  two times or press .

Number Format

The tester can show decimal fractions with a decimal point (0.00) or a comma (0,00).

- 1 On the home screen, tap the **TOOLS** icon.
- 2 In the **Number** panel, tap the control to show **0.0** or **0,0**.
- 3 To go back to the home screen, tap  or press .



Units for Length Measurements

- 1 On the home screen, tap the **TOOLS** icon.
- 2 In the **Length** panel, tap the control to show **ft** or **m**.
- 3 To go back to the home screen, tap  or press .

Power-Down and Backlight Timeout Periods

To increase the battery life, the tester can turn off the backlight and automatically turn off the tester when you do not press any keys for a specified period.



When the backlight timeout period ends, the brightness of the backlight decreases. After one more timeout period, the display turns off. Touch the display to turn it on.

- 1 On the home screen, tap the **TOOLS** icon.
- 2 Tap **Timeout Period**, then tap **Backlight** or **Power Down**.
- 3 Tap a time. To always keep the backlight or tester on, tap **Disabled**.
- 4 To go back to the home screen, tap  two times or press .

The DSX-600 remote tester turns off after 60 minutes of inactivity. You cannot change this setting.



Audible Tone

You can enable or disable the tones the tester makes during tests and when you press keys. If you connect a remote tester to the main tester, the remote uses the main tester's setting.

- 1 On the home screen, tap the **TOOLS** icon.
- 2 In the **Audible Tone** panel, tap the control to show **On** or **Off**.
- 3 To go back to the home screen, tap  or press .

Power Line Frequency

Set the power line frequency to the power frequency in the area where you will use the tester. This setting decreases the effects of ac noise on the circuits in the tester.

- 1 On the home screen, tap the **TOOLS** icon.
- 2 In the **Power Line Frequency** panel, tap the control to show **50 Hz** or **60 Hz**.
- 3 To go back to the home screen, tap  or press .

Display Brightness

- 1 On the home screen, tap the **TOOLS** icon, then tap **Display**.
- 2 On the brightness scale, tap or slide the yellow bar to adjust the brightness, then tap **DONE**.

Note

When you increase the display brightness, the battery life decreases.

- 3 To go back to the home screen, tap  or press .

Import User Preferences from a File

You can use LinkWare PC software to make a file that contains settings for user preferences, then you can import the file into the tester. You can also export settings from a tester to the PC. See the online help in LinkWare PC for instructions.

Overview of Memory Functions

You can save approximately 12,700 Cat 6A Autotest results, with plot data included, in the DSX-600 main tester.

The capacity available for test results depends on the space used by the software and custom test limits in the tester.

To see the memory status

On the home screen, tap the **TOOLS** icon, then tap **Memory Status**.

To make more memory available, you can export results to a USB flash drive, then delete the results in the tester. See “Manage Results on a Flash Drive” on page 146.

How to Install a Strap

The DSX-600 includes a carrying strap that lets you carry and hang the tester. A hand strap that helps you hold the tester is also available. You can purchase a hand strap from an authorized Fluke Networks distributor. Figure 10 shows how to install a strap and how to use the optional hand strap.

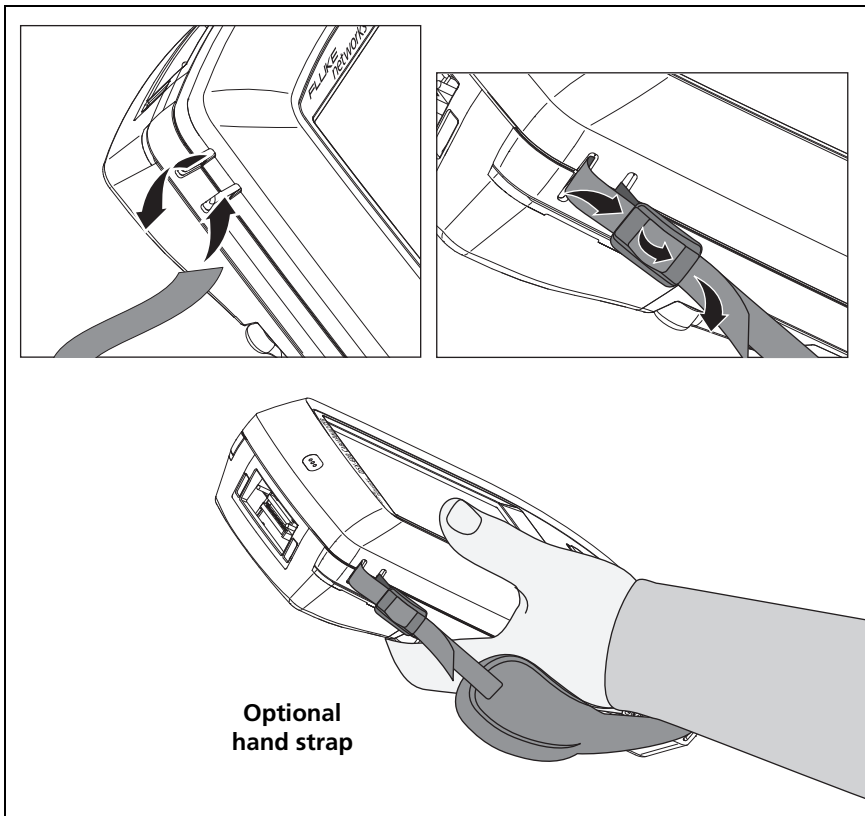

BA43.EPS

Figure 10. How to Install a Strap and Use the Optional Hand Strap

About LinkWare Applications

LinkWare PC Cable Test Management Software

The LinkWare PC Cable Test Management software lets you upload test records to a PC, organize and examine test results, print professional-quality test reports, and do software updates and other maintenance procedures on your tester.

You can download LinkWare PC from the Fluke Networks website.

The LinkWare Live Web Application

The LinkWare Live web application lets you manage your projects from a desktop or mobile device:

To get started with LinkWare Live, see Chapter 9.

LinkWare Stats

The LinkWare Stats Statistical Report software that is included with LinkWare software provides statistical analysis of cable test reports and generates browsable, graphical reports.

For instructions about LinkWare PC and LinkWare Stats software, see the guides for getting started and the online help available under **Help** on the LinkWare PC and LinkWare Stats menus.

Chapter 2: Get Started



Warning
Before you use the tester, read the safety information that starts on page 4.

Tutorial: Certify Twisted Pair Cabling

The tutorial in this section gives instructions on how to set up a test to certify twisted pair cabling, do the test, and save the results.

Figure 11 shows the minimum equipment necessary for this tutorial.

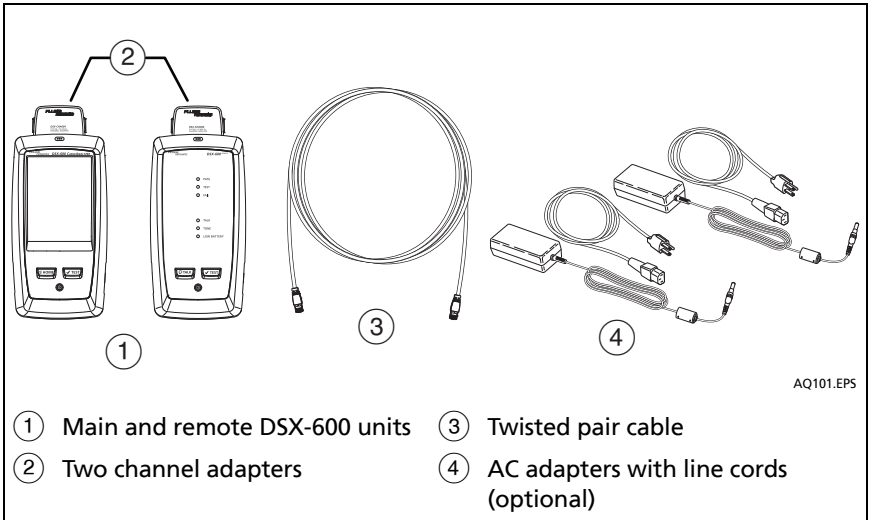

Figure 11. Equipment for the Twisted Pair Certification Tutorial

Step 1: See How Much Memory is Available

On the home screen, tap the **TOOLS** icon, then tap **Memory Status**.

The **MEMORY STATUS** screen shows these values:

- The percentage of memory available
- The number of test records that are saved
- The number of ID sets that have been downloaded to the tester from LinkWare PC or LinkWare Live.
- The memory space taken by other files, such as the databases for projects and limits.

Step 2: Set Up a Twisted Pair Test

2-1 On the home screen, tap the test setup panel.

2-2 On the **CHANGE TEST** screen, tap **NEW TEST**.

2-3 On the **TEST SETUP** screen, tap each setting to make these selections:

- **Cable Type:** This is the type of cable you will test. The **CABLE TYPE** screen shows the last 10 types of cable that were selected. Tap the correct cable type.

If you do not see the correct cable type, tap **MORE**, tap the name of a cable group, then tap a cable in the group.

- **NVP:** Nominal velocity of propagation, which the tester uses to calculate length. For this tutorial, use the default value. The default value is defined by the selected cable type and is the typical NVP for that cable type.
- **Shield Test:** This setting shows only when you select a shielded cable type. If you selected a shielded cable type, select **On** for this setting.

- **Test Limit:** The test limit specifies the limits for measurements so that the tester can give a **PASS** or **FAIL** result to the test. The **TEST LIMIT** screen shows the last 10 limits that were selected.

If you do not see the correct test limit, tap **MORE**, tap the name of a group, then tap a test limit.

- **Store Plot Data:** If **Store Plot Data** is **Off**, the tester does not save plot data for frequency-domain tests or for the HDTDR/HDTDX analyzers. You can see the plots before you save the test and exit the results screen. If **Store Plot Data** is **On**, the tester saves plot data for frequency-domain tests.

Make sure that **Store Plot Data** is **On**. If it is not, tap the **On/Off** control.

- **HDTDR/HDTDX:** This setting lets you see results from the HDTDR™ and HDTDX™ analyzers only when a test gets a **FAIL** or **PASS*** result, or after every Autotest. The analyzer results help you locate the causes of **FAIL** and **PASS*** results. These tests are not required by any test limit. To always see these results, select **All Autotests**.
- **Outlet Configuration:** This is the wire map for the cable. The **Test Limit** you select determines which **Outlet Configurations** you can select on the **OUTLET CONFIG** screen.

If the correct outlet configuration does not show, tap **Outlet Configuration**. On the **OUTLET CONFIG** screen, tap the correct configuration, then tap **USE SELECTED**.

- **AC Wire Map:** This setting lets you do tests on links connected through midspan PoE (Power over Ethernet) devices. For this tutorial, make sure this setting is **Off**.

2-4 On the **TEST SETUP** screen, tap **SAVE**.

2-5 On the **CHANGE TEST** screen, tap the twisted pair test you made, then tap **USE SELECTED**.

For more information on settings, see “Settings for Twisted Pair Tests” on page 49.

Step 3: Turn Off the Auto Save Function

For this tutorial, you will manually save the test results.

- 3-1 On the home screen, tap the **Next ID** panel.
- 3-2 On the **CHANGE ID** screen, tap the **Auto Save** control to make it show **Off**.
- 3-3 Tap **DONE**.

Step 4: Do an Autotest

- 4-1 Attach the channel adapters to the main and remote testers.
- 4-2 Turn on both testers, then connect a twisted pair cable between the adapters.
- 4-3 Tap **TEST** on the main tester or press **TEST** on the main or remote tester.

Step 5: Look at the Results

The tester shows the Autotest results in three formats (Figure 12):

- **WIRE MAP:** Shows the connections between the ends of the cable.
- **PERFORMANCE:** Shows the overall result for each test. Use this screen to quickly see which test failed.
- Plot and tabular results screens: Tap a test on the **PERFORMANCE** screen to see a table or plot of the results.
- If you set **HDTDR/HDTDx** to **All Autotests**, you can see the analyzers' results on the **DIAGNOSTIC** tab.

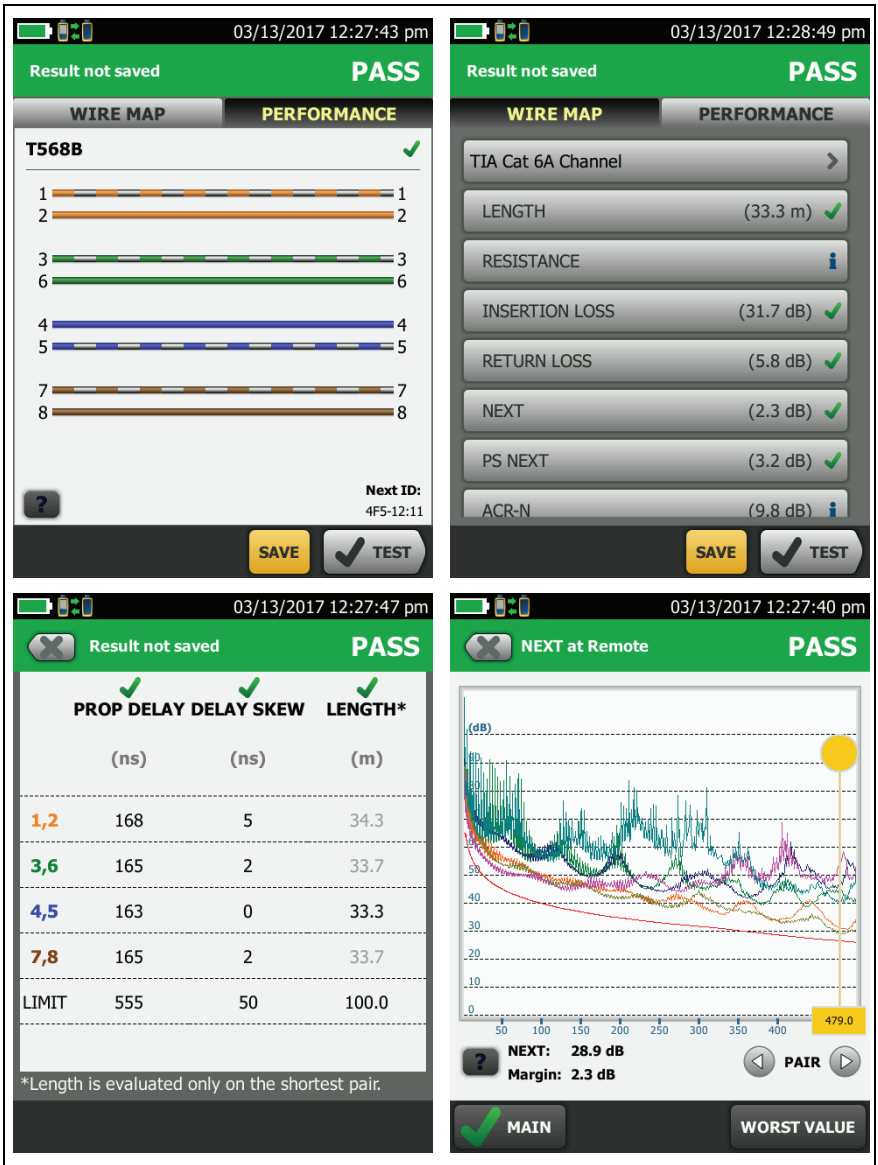

BA103.EPS

Figure 12. Examples of Twisted Pair Autotest Results Screens

Step 6: Save the Results

- 6-1 Tap **SAVE** (if the result was **PASS**) or **FIX LATER** (if the result was **FAIL**).
- 6-2 On the **SAVE RESULT** screen, tap the **Cable ID** box, use the keyboard to enter an ID for the results, then tap **DONE**.
- 6-3 Tap **SAVE**.

Buttons to Do Tests and Save Results

When more than one button shows at the bottom of the screen, the tester highlights one in yellow to recommend which one to tap.

Note

To change the **Auto Save** setting, tap the **Next ID** panel on the home screen.

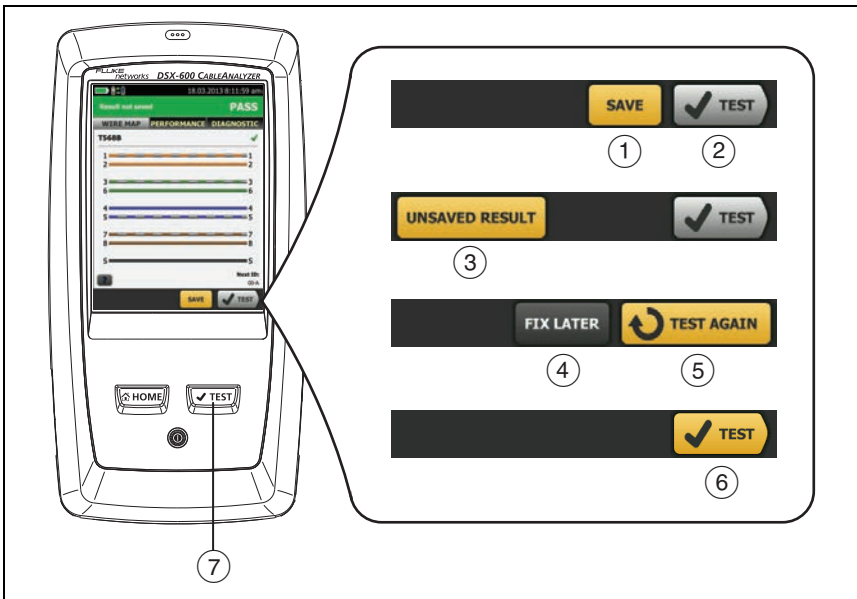

AQ40.EPS

Figure 13. **FIX LATER**, **TEST AGAIN**, and **TEST** Buttons and the **TEST** Key

- ① **SAVE** (yellow), ② **TEST** (gray): These buttons show if the test passed and **Auto Save** is off. When you tap **SAVE**, you can save the results with an ID that you make or select. When you tap **TEST**, you can select to save the results or do the test again and not save the results.
- ③ **UNSAVED RESULT**: This button shows if **Auto Save** is off and you go to the home screen when a test is completed. Tap this button to see the result.
- ④ **FIX LATER**: This button shows if the test failed or had a **PASS*** result and the result has not been saved.
- ⑤ **TEST AGAIN**: This button shows if the test failed or had a **PASS*** result. Tap this button to do the test again. If the test fails again, you can tap **FIX LATER** to save the result if necessary.

When you look at a saved result that failed, tap **TEST AGAIN** to do the test again for the same ID and with the same test settings as the saved result.

Note

*The color of the **FIX LATER** and **TEST AGAIN** buttons (yellow or gray) depends on which button you tapped the last time you did a test that failed.*

- ⑥ **TEST** (yellow): This button shows if the test passed and **Auto Save** is on. When **Auto Save** is on, the tester saves results with the next available ID when the test is completed. When you tap **TEST**, the tester does a test for the next available ID.
- ⑦ **✓TEST**: The **✓TEST** key does the same function as the **TEST** button. When **TEST AGAIN** shows, you can press **✓TEST** to do a test on the next ID.

Options for Cable IDs

When you save the test results for a cable, you usually give the results the name that is the ID for the cable. There are several methods you can use to make IDs for test results:

- You can use the **CABLE ID SETUP** screen to make a set of sequential IDs. See "Tutorial: Make a Set of Sequential Cable IDs" on page 40. When **Auto Save** is also on, the tester automatically saves each result with the next available ID in the set.

A cable ID set also lets you use IDs again so you can add different results to tests you saved before.

- You can enter an ID each time you do a test. To do this, turn off the **Auto Save** function (see page 39). Each time a test is completed, tap **SAVE** (if the test passed) or **FIX LATER** (if the test failed), then enter an ID manually.
- You can use LinkWare PC software to make a set of IDs, download the set to the tester, then import it into a project. See "Import an ID Set into a Project" on page 169.
- After you do a test, you can enter the ID for a test you saved before. This lets you replace results or add different results to a test you saved before.
- If the test failed before, and you saved the results, you can select it on the **RESULTS** screen, then press **TEST AGAIN** to replace the results for that ID.

Notes

Cable IDs are case-sensitive. For example, the tester saves result with the names "A0" and "a0" in two different records.

Cable IDs can have a maximum of 60 characters.

If you delete all the ID sets in a project, the tester makes a default set that starts with 001.

Automatic Increment Function for Cable IDs

Each time you save a result, the tester automatically saves the result with the next ID in the set. It is not necessary for the IDs in a set to be sequential. For example, an ID set that you make with LinkWare PC or LinkWare Live software can have these non-sequential IDs:

B-1A

B-1B

RFS-A

RFS-B

CAM1-A

CAM1-B

After you save results for all IDs in a set, the auto increment function does not operate. You must manually enter an ID each time you save a result, unless you select a different ID set.

If you enter an ID when you save a test, and the ID is not in the sequence of the set, the tester uses that ID, then goes back to the next ID in the set.

Auto Save Function

The **Auto Save** function automatically saves results after each test. This function decreases the time necessary to do a job.

To turn the Auto Save function on or off

- 1 On the home screen, tap the **Next ID** panel.
- 2 On the **CHANGE ID** screen, tap the **On/Off** control next to **Auto Save**.

If **Auto Save** is on and the test passed, the tester saves the results with the next available ID in the set.

If **Auto Save** is on and the test failed:

- To save the failed result before you do a test for the next ID, tap **FIX LATER**.
- To do the test again for the same ID, tap **TEST AGAIN**.

You can also change the **Auto Save** setting on the **SAVE RESULTS** screen. You can see this screen after you run a test.

Tutorial: Make a Set of Sequential Cable IDs

You can make a set of sequential cable IDs to use when you save test results. When you save results, you can use the next ID in the set as the name for the results, or you can select another ID in the set.

When you make an ID set, you enter the first and last IDs in the set. The tester increments the characters that are different in the first and last IDs. For example, the first and last IDs "TELECOM-A1" and "TELECOM-B2" make a set with four IDs:

TELECOM-A1
TELECOM-A2
TELECOM-B1
TELECOM-B2

You can make up to 50 cable ID sets with up to 5000 IDs total for all sets. An ID can have a maximum of 60 characters. Accented characters and symbols, such as the asterisk, do not increment.

Notes

When you make an ID set, the tester saves it in the project shown on the home screen. For information on projects, see Chapter 8.

To make a set of sequential IDs

Example: You will do tests on four cables (A through D) in 10 rooms (01 through 10) on the first and second floors, for a total of 80 cables.

- 1 On the home screen, tap the **PROJECT** panel.
- 2 To save the ID set in a different project, tap **CHANGE PROJECT**, then tap a project.
- 3 On the **PROJECT** screen, tap **NEW ID SET**.
- 4 On the **CABLE ID SETUP** screen, tap the **First ID** panel, then use the keyboard to enter the first ID in your sequential set. For this example, enter 1-01-A.
- 5 Tap the **Last ID** panel, use the keyboard to enter the last ID in your sequential set, then tap **DONE**. For this example, enter 2-10-D.
- 6 To see the ID set, tap **REVIEW**.
- 7 On the **CABLE ID REVIEW** screen or the **CABLE ID SETUP** screen, tap **Save**.

About Projects

The ProjX™ management system lets you set up a project to specify the settings necessary for a job, to monitor the status of a job, and organize your test results. See Chapter 8.

The tester saves your settings and test results in the **DEFAULT** project, unless you select a different project.

Chapter 3: Certify Twisted Pair Cabling

The DSX-600 CableAnalyzer Home Screen



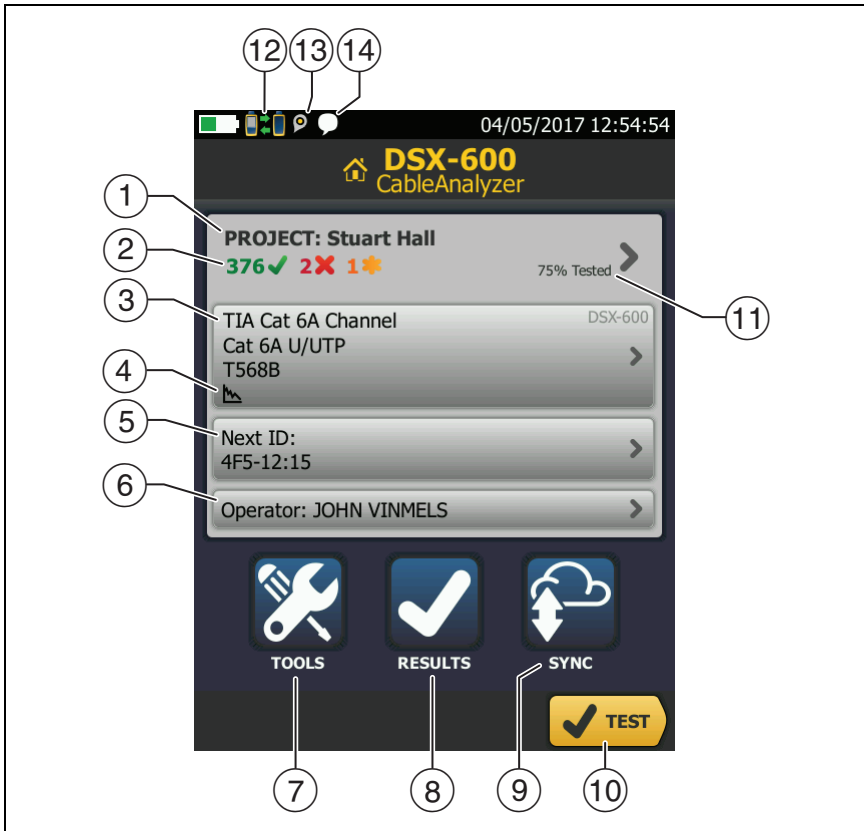

The home screen (Figure 14) shows important test settings. Before you do a test, make sure these settings are correct.





BA110.EPS

Figure 14. The Home Screen for DSX-600 CableAnalyzer

- ① **PROJECT:** The project contains the settings for a job and helps you monitor the status of a job. When you save test results, the tester puts them in the project. Tap the **PROJECT** panel to edit the project settings, select a different project, or make a new project.

- ② Shows a summary of the test results in the project:
-  The number of tests that passed.
 -  The number of tests that failed.
 -  The number of results from tests on twisted pair cable that have **PASS*** results. **PASS*** results have measurements within the range of accuracy uncertainty for the tester. See “**PASS*/FAIL* Results**” on page 58.
- ③ The test setup panel shows the settings the tester will use when you tap **TEST** or press . To change these settings, tap the panel.
- ④ Icons show the status of the **Store Plot Data** and **AC Wire Map** settings. See Table 2 on page 51.
- ⑤ **Next ID:** The **Next ID** panel shows the ID that the tester gives to the next test results you save.
- Tap **Next ID** to do these tasks:
- Enter an ID, select a different ID in the ID set, select a different set of IDs, or make a new set. The tester adds the IDs and ID sets you make to the project that shows on the home screen.
 - Turn **Auto Save** on or off.
- ⑥ **Operator:** The name of the person who does the job. You can enter a maximum of 20 operator names. For each operator you can also enter the email address that the operator will use as an ID to sign in to LinkWare Live.
- ⑦ **TOOLS:** The **TOOLS** menu lets you set the reference, see the status of the tester, and set user preferences such as the language and the display brightness.
- ⑧ **RESULTS:** Tap **RESULTS** to see and manage the results that are saved in the tester.

- ⑨ **SYNC:** To upload results to LinkWare Live, tap **SYNC**. See Chapter 9.
- ⑩ **TEST:** Tap **TEST** to do the test shown in the test setup panel.
- ⑪ The percentage of the project that is completed. The percentage is the number of IDs used for saved results divided by the total number of used and available IDs in the project.
% Tested does not show if your project contains only a **Next ID** list. See “About Next ID Sets” on page 168 for more information about the **Next ID** list.
- ⑫  This icon shows when the tester’s link interface adapter is connected to the adapter on a DSX-600 remote and the remote is turned on.
- ⑬  The asset management icon shows when the owner of a LinkWare Live account has enabled the asset management service for the tester. See “About the Asset Management Service” on page 179.
- ⑭  This icon shows when the talk function is on. See “How to Use the Talk Function” on page 95.

Make Sure Your Tester is Ready to Certify Twisted Pair Cabling

To make sure your tester meets its accuracy specifications, follow these guidelines:

- Keep the tester's software current. The latest software is available on the Fluke Networks website. See "Update the Software" on page 192.
- At a minimum, set the reference for the twisted pair adapters every 30 days. Because this procedure includes a self test and helps ensure maximum accuracy of test results, the best practice is to set the reference each day. See "Set the Reference" on page 48.
- Make sure you select the correct cable type for the job, and that the NVP for the cable is correct. See Table 2 on page 50.
- Make sure you select the correct test limit for the job. See Table 2 on page 50.
- Make sure the cords and connectors for all test equipment and patch cords are in good condition.
- Make sure the battery is fully charged.
- Send the testers to a Fluke Networks service center every 12 months for factory calibration.

Set the Reference

The reference procedure for twisted pair cable sets the baseline for insertion loss, ACR-F, and DC resistance measurements.

Set the reference at these times:

- Every 30 days, at minimum.
- To ensure maximum accuracy of test results, set the reference daily.

It is not necessary to set the reference when you change the link interface adapters.

To set the reference

- 1 Turn on the tester and the remote a minimum of 5 minutes before you set the reference.

Note

Set the reference only after the testers are at an ambient temperature between 50 °F and 104 °F (10 °C and 40 °C).

- 2 Use the reference patch cord and two channel adapters or permanent link and channel adapters to connect the main and remote testers together as shown in Figure 15.

Note

If you use a DSX

- 3 On the home screen, tap **TOOLS**, then tap **Set Reference**.
- 4 On the **SET REFERENCE** screen tap **TEST**.

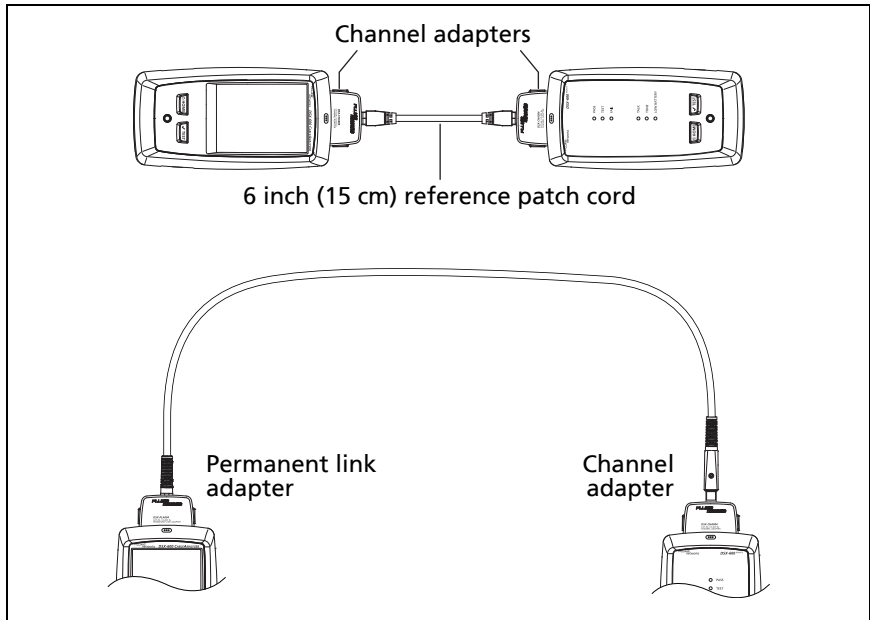

BA89.EPS

Figure 15. Reference Connections for Twisted Pair Cable

Settings for Twisted Pair Tests

Table 2 gives descriptions of the settings for twisted pair tests. To set up a project, which includes the settings in Table 2, cable IDs, and operator names, see Chapter 8.

To set up a twisted pair test

- 1 On the home screen, tap the test setup panel.
- 2 On the **CHANGE TEST** screen, select a twisted pair test to change, then tap **EDIT**.
Or to set up a new twisted pair test, tap **NEW TEST**.
- 3 On the **TEST SETUP** screen, tap the panels to change settings for the test. See Table 2.

-continued-

- 4 On the **TEST SETUP** screen, tap **SAVE** when your test setup is completed.
- 5 On the **CHANGE TEST** screen, make sure the button next to the test is selected, then tap **USE SELECTED**.

Table 2. Settings for Twisted Pair Tests





Setting	Description
Cable Type	Select a cable type that is correct for the type you will test. To see a different group of cable types, tap MORE , then tap a group. To make a custom cable type, select Custom in the Cable Groups list. See Chapter 10 for details.
NVP	Nominal velocity of propagation. The tester uses the NVP and the propagation delay to calculate the length of the cable. The default value is defined by the selected cable type and is the typical NVP for that cable type. To enter a different value, tap the NVP panel, then tap  or  on the NVP screen to increase or decrease the value. To find the actual value for a cable, connect a known length of the cable to the tester, tap MEASURE on the NVP screen, then change the NVP until the measured length matches the known length. Use a cable at least 30 m (100 ft) long. When you increase the NVP value, the calculated length increases.
Shield Test	This setting shows only when you select a shielded cable type. On: The wire map test includes a DC test for shield continuity and AC tests for shield quality. The wire map test fails if the shield is open or the AC test results are unsatisfactory. Off: The wire map shows the shield if the shield has continuity. The tester does not do AC tests for shield quality. The wire map test does not fail or show the shield if the shield is open.

Table 2. Settings for Twisted Pair Tests (continued)

Setting	Description
Test Limit	Select the correct test limit for the job. To see a different group of limits, tap MORE , then tap the name of a group.
Store Plot Data	<p>Off : The tester does not save plot data for frequency-domain tests or for the HDTDR/HDTDX analyzers. You can see the plots before you save the test and exit the results screen. The saved results show frequency-domain measurements in a table and do not include the HDTDR/HDTDX plots.</p> <p>On : The tester saves plot data for all frequency-domain tests required by the selected test limit and for the HDTDR/HDTDX analyzers.</p>
HDTDR/HDTDX	<p>Fail/Pass* only: The tester shows HDTDR and HDTDX analyzer results only for Autotests with PASS*, FAIL*, or FAIL results.</p> <p>All Autotests: The tester shows HDTDR and HDTDX analyzer results for all Autotests.</p> <p>To get HDTDR/HDTDX analyzer results you can also tap Tools > Diagnostics.</p> <p>For more information about the HDTDR and HDTDX analyzers, see Chapter 6.</p>

-continued-

Table 2. Settings for Twisted Pair Tests (continued)

Setting	Description
<p>Outlet Configuration</p>	<p>The Outlet Configuration specifies which wire pairs are tested and which wire numbers the wire map shows for the pairs. See Figure 16.</p> <p>To see the wire map for a configuration, tap Outlet Configuration, tap the configuration name on the OUTLET CONFIG screen, then tap SAMPLE.</p> <p>To select a configuration, tap a name on the OUTLET CONFIG screen, then tap USE SELECTED.</p> <p style="text-align: center;"><i>Note</i></p> <p style="text-align: center;"><i>The OUTLET CONFIG screen shows only the configurations that are applicable to the selected Test Limit.</i></p> <p>To make a custom outlet configuration, tap CUSTOM on the OUTLET CONFIG screen, then tap MANAGE, then tap Create. See Chapter 10 for details.</p>
<p>AC Wire Map</p>	<p>The AC Wire Map test lets you do tests on links connected through midspan PoE (Power over Ethernet) devices. See Chapter 4.</p> <p>When the AC Wire Map test is on, this icon shows on the home screen: </p> <p style="text-align: center;"><i>Notes</i></p> <p style="text-align: center;"><i>Always turn off the AC wire map test when you will not do tests through a PoE device. The AC wire map test increases the time for an Autotest. It also disables the resistance and shield continuity tests.</i></p>

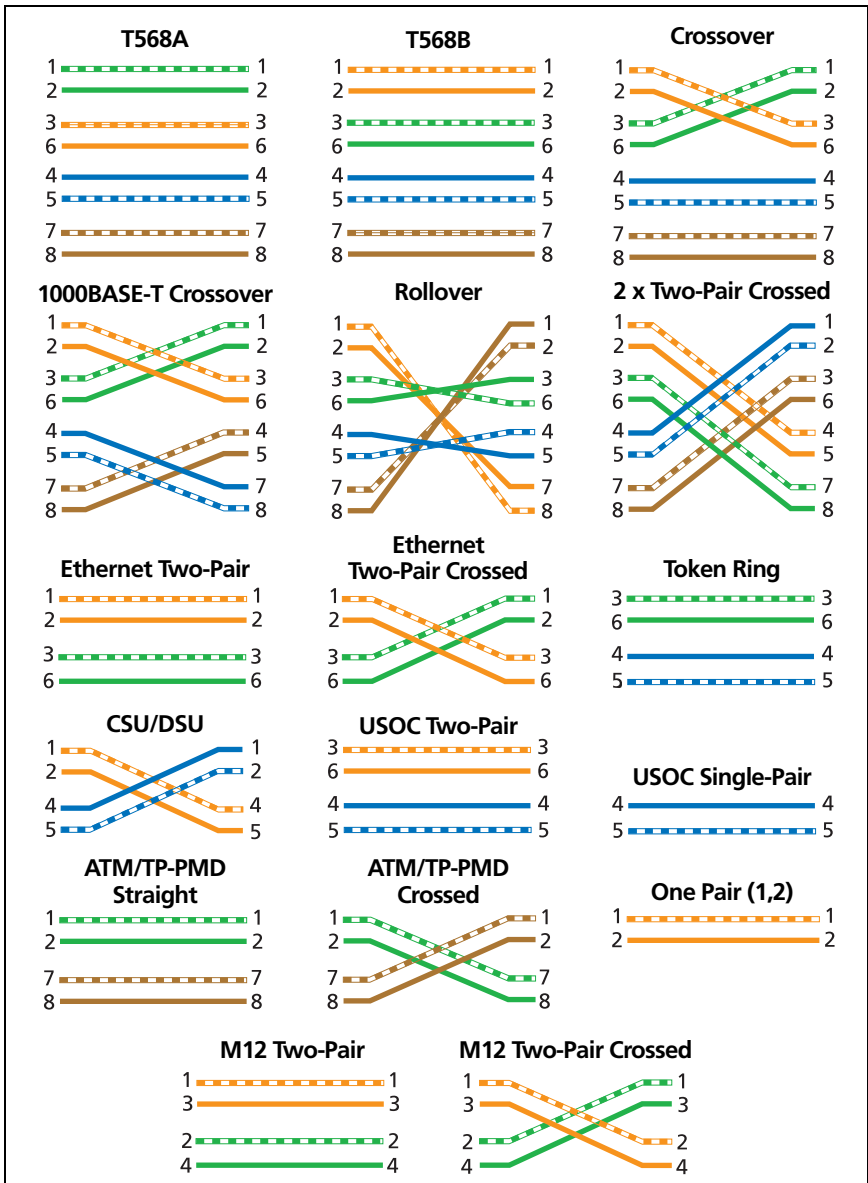

GPU85.EPS

Figure 16. Outlet Configurations

How to Do an Autotest

When you tap **TEST** on the main tester or press  on the main or remote tester, the testers do an Autotest. The Autotest includes all the tests necessary to certify that the cabling meets or exceeds the performance requirements specified in the selected test limit.

Figure 17 shows the equipment for Autotests on twisted pair cable.

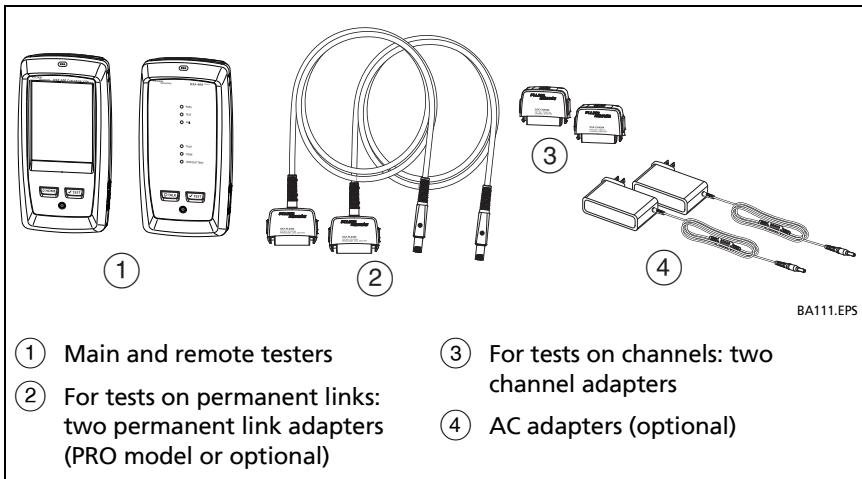

Figure 17. Equipment for Autotests on Twisted Pair Cable

Note

*If you have two main testers, you can use one as a remote. To select the remote function, tap **TOOLS** > **Main as Remote**.*

To do an Autotest on twisted pair cable

- 1 Attach permanent link or channel adapters to the main and remote testers.
- 2 Make sure that the home screen shows the correct settings for the job.

To make sure that other settings are correct, tap the test setup panel, make sure the correct test is selected on the **CHANGE TEST SCREEN**, then tap **EDIT** to see more settings. Table 2 on page 50 describes the settings.

- 3 Connect the testers to the link as shown in Figure 18 or 19.
- 4 Tap **TEST** on the main tester or press  on the main or remote tester.

If the tester at the other end of the cable is in sleep mode or is off, your tester's tone generator turns on the other tester.

If the two testers are not connected:

- Your tester's tone generator stays on so you can use a tone probe to find the cable to connect to the other tester.
- Or, tap **MEASURE** to do the tests that do not require a remote tester. Because the tester cannot complete all tests and some tests always fail with no remote connected, the result for an Autotest without a remote is always **FAIL**.

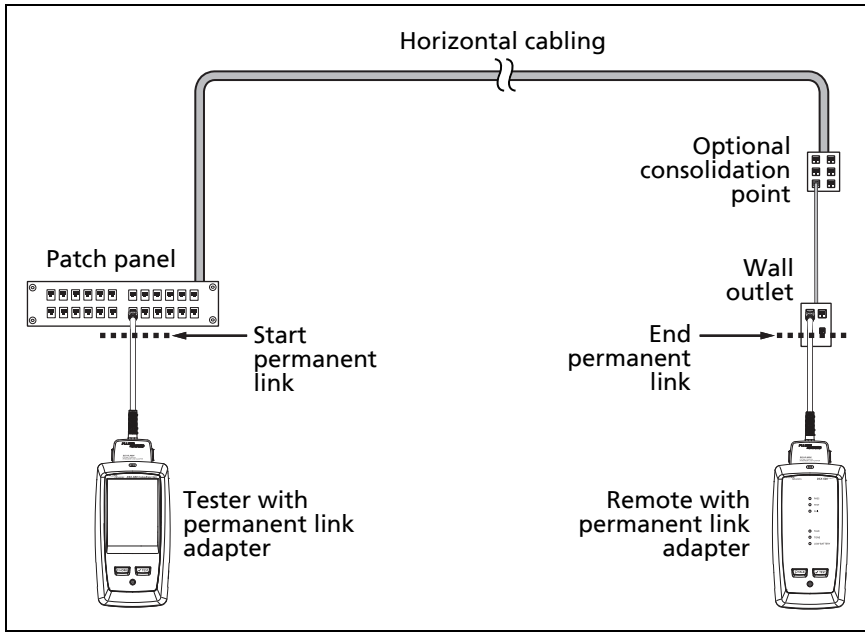

BA97.EPS

Figure 18. Permanent Link Connections

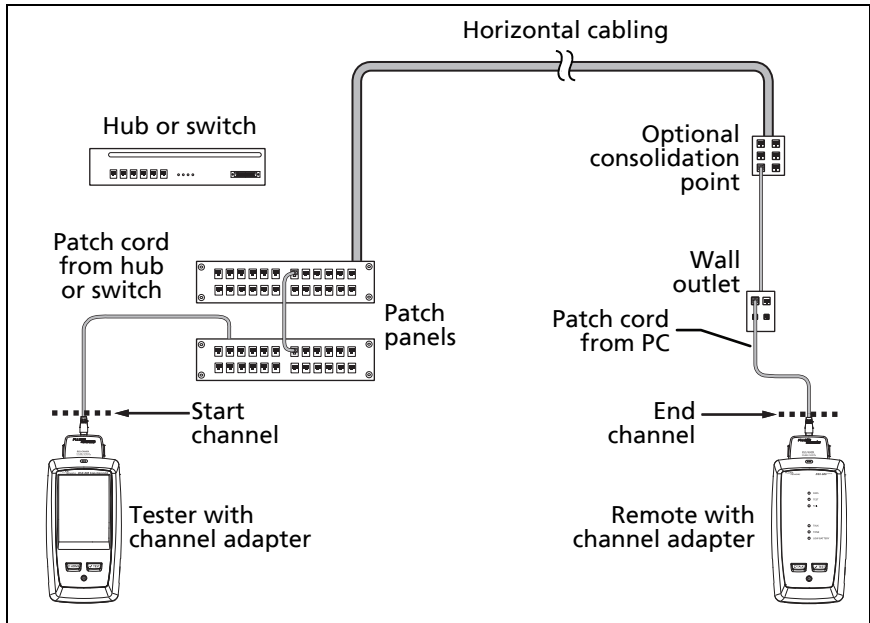

Figure 19. Channel Connections

“Bad Patch Cord” Message

To comply with standards for tests on channels, the tester removes the effects of the channel adapters and their connections from the test results. Before it removes these effects, the tester makes sure that the plugs on the patch cord do not have too much near-end crosstalk (NEXT). Too much NEXT is frequently caused by too much untwisted wire in the plug. If a plug is bad, the tester shows the message **Bad patch cord at main** or **Bad patch cord at remote**, and does not remove the effects of the channel adapters and their connections. The tester saves the message with the results.

If you see one of these messages, replace the patch cord or install a new plug at the bad end.

Twisted Pair Autotest Results

The tests listed below apply to twisted pair cabling.

Note

Some tests are not included in some test limits.

- Wire map
- Resistance
- Length
- Propagation delay
- Delay skew
- Insertion loss (attenuation)
- Impedance
- NEXT (near-end crosstalk)
- PS NEXT (power-sum near-end crosstalk)
- ACR-N (attenuation to crosstalk ratio at the near end)
- PS ACR-N (power-sum attenuation to crosstalk ratio, near end)
- ACR-F (attenuation to crosstalk ratio at the far end)
- PS ACR-F (power-sum attenuation to crosstalk ratio, far end)
- Return loss
- HDTDR and HDTDX analyzers (optional tests, not required by any test limit. See Chapter 6.)

PASS*/FAIL* Results

A result shows an asterisk when measurements are in the tester's accuracy uncertainty range (Figure 20) and the asterisk is required by the selected test limit. These results are marginal.

-  A **PASS*** shows that the cable's performance is satisfactory. If a cable must get a **PASS** result to agree with your requirements for quality, identify and correct the problems with the cable and do the Autotest again.

-  Usually, a **FAIL*** is not a satisfactory result. The tester shows a **FAIL** for the overall result. Identify and correct the problems with the cable and do the Autotest again.

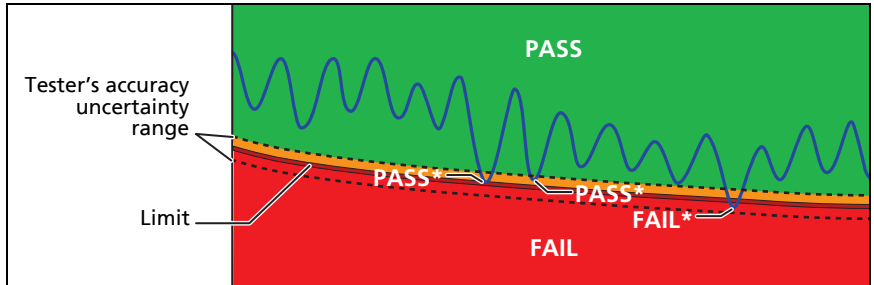

Figure 20. PASS* and FAIL* Results

GPU87.EPS

WIRE MAP Tab

The **WIRE MAP** tab shows the connections between the ends of the cable under test. The tester compares the connections to the selected **Outlet Configuration** to get a **PASS** or **FAIL** result.

If the wire map test fails, you can continue or stop the Autotest. Or, you can tap **SCAN ON** to do the wire map test continuously while you look for the fault. To continue the Autotest after you correct the fault, tap **SCAN OFF**, then tap **CONTINUE**.

If you leave then return to the **WIRE MAP FAIL** screen, the **SCAN ON** button goes away. To see the button again, tap **TEST AGAIN**. You can also select the continuous wire map test as a single test from the **TOOLS** menu. See "Continuous Tests" on page 70.

Figures 22, 23, and 24 show examples of wire map screens. For information on AC wire map screens, see Chapter 4.

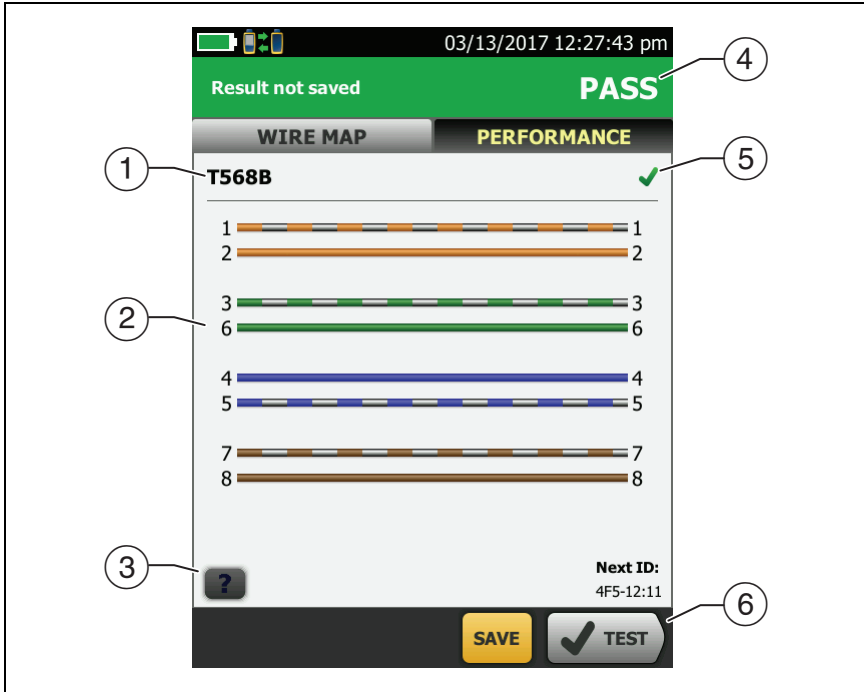





Figure 21. WIRE MAP Tab

BA59.EPS

- ① The name of the outlet configuration used for the test. The outlet configuration is a setting on the **TEST SETUP** screen.
- ② The wire map of the cabling. The main tester is at the left side of the wire map.
- ③ Tap  to see information about wire map faults. If  shows, tap it to see a message about the results, such as **Bad patch cord at remote**.
- ④ The overall result for the Autotest. If the result shows an asterisk, See "PASS*/FAIL* Results" on page 58.
- ⑤ The result for the wire map test:
 The wire map does not agree with the outlet configuration selected for the test.

- ✓ The wire map agrees with the outlet configuration selected for the test.
- ⑥ When more than one button shows at the bottom of the screen, the tester highlights one in yellow to recommend which one to tap. See “Buttons to Do Tests and Save Results” on page 36.

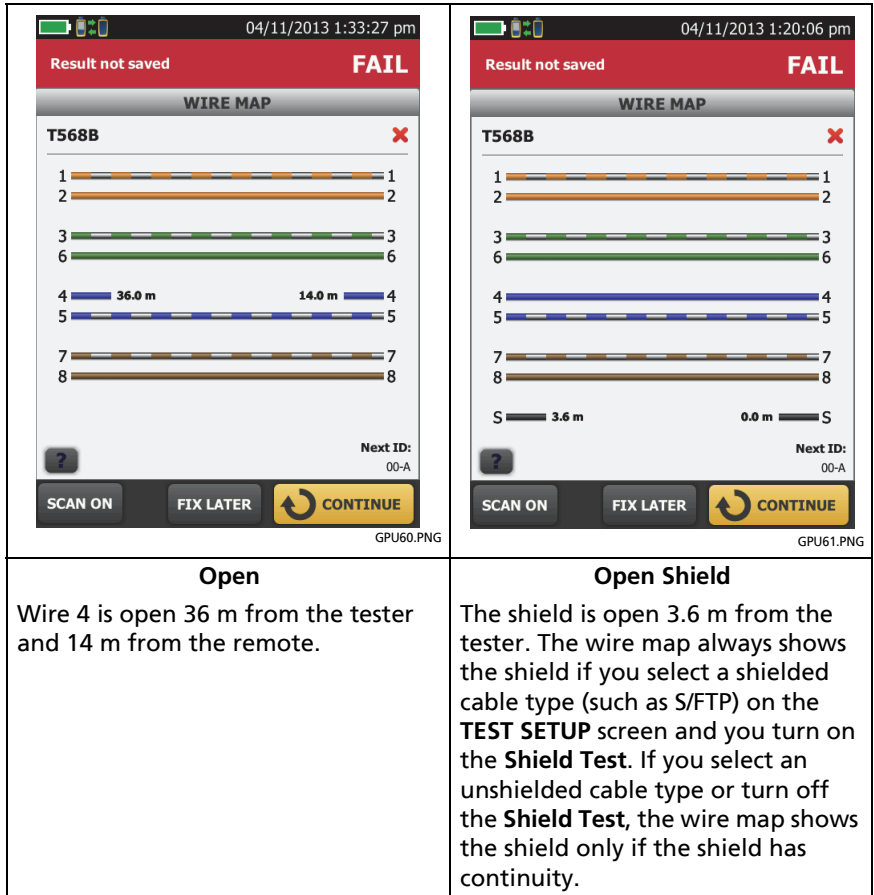

Figure 22. Wire Map Examples: Open Wire and Open Shield

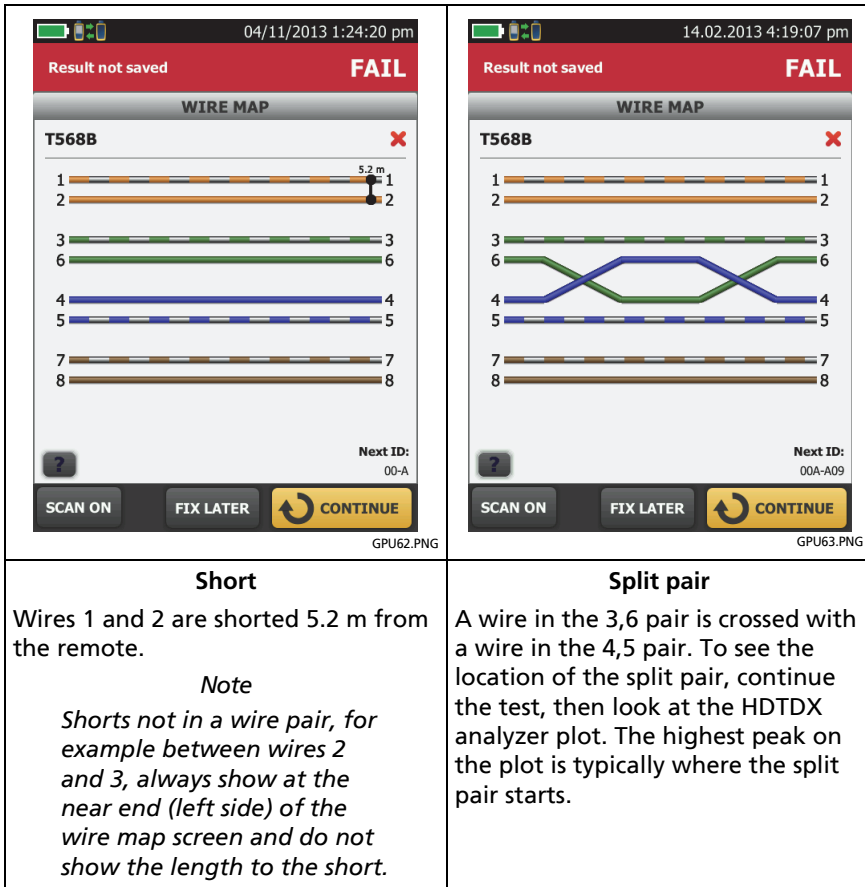

Figure 23. Wire Map Examples: Short and Split Pair

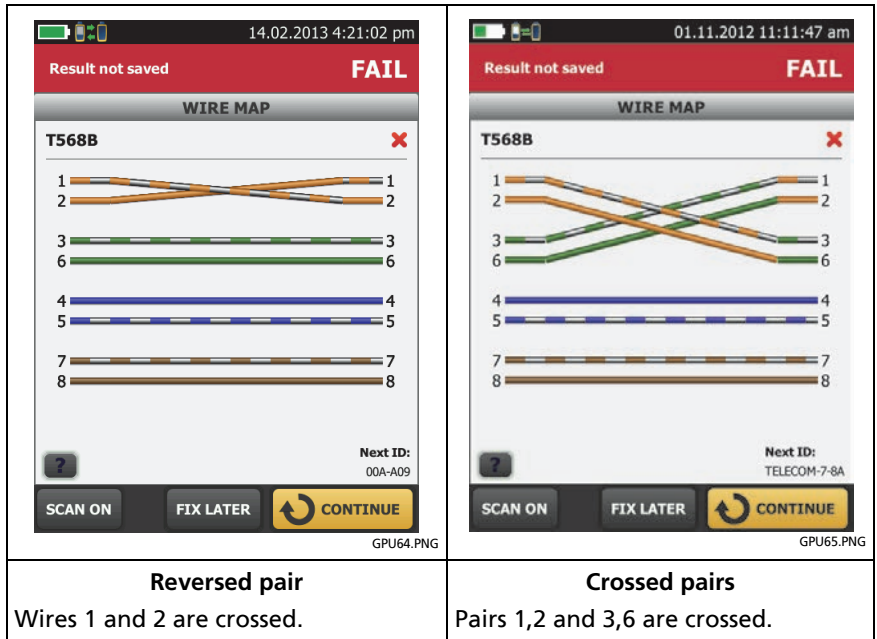
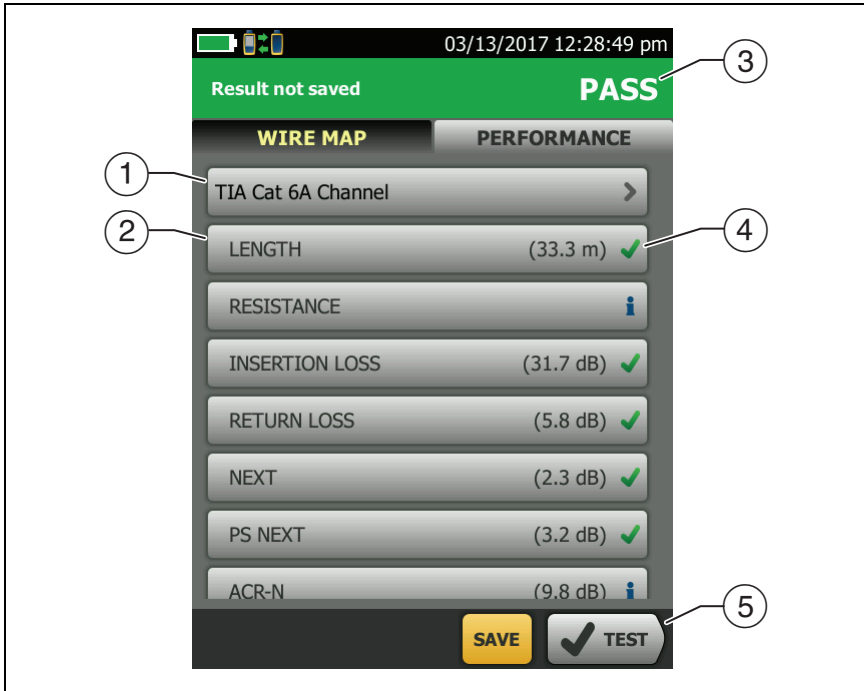

Figure 24. Wire Map Examples: Reversed Pair and Crossed Pairs

PERFORMANCE Tab

The **PERFORMANCE** tab (Figure 25) shows the overall result for each test that is required by the selected test limit.



BA86.EPS

Figure 25. PERFORMANCE Tab

- ① The test limit and cable type used for the test.
- ② To see detailed results for a test, tap the panel.
- ③ The overall result for the Autotest. If the result shows an asterisk, See "PASS*/FAIL* Results" on page 58.
- ④ The overall result for the test:
 - ✗ The results exceed the limit.
 - ✓ The results are within the limit.

 The selected test limit does not have a limit for the test, or a dB rule applies. See “About dB Rules” on page 90.

 The results are within the range of accuracy uncertainty for the tester. See “PASS*/FAIL* Results” on page 58.

The measurement shown for frequency-domain results is the worst margin. (The insertion loss plot is different. See “Insertion Loss” on page 74.)

- ⑤ When more than one button shows at the bottom of the screen, the tester highlights one in yellow to recommend which one to tap. See “Buttons to Do Tests and Save Results” on page 36.

Scalar Results

Scalar results are measurements that do not change with frequency. These are the **Length**, **Propagation Delay**, **Delay Skew** and **Resistance** results. These results do not have plot data.

Length, Propagation Delay, and Delay Skew

The length results show the length, propagation delay, and delay skew of each cable pair. See Figure 26.

The length shown on the **PERFORMANCE** screen is the length of the shortest pair. The tester uses the length of only the shortest pair to get a **PASS** or **FAIL** result for the length test.

Note

If the length of the shortest pair does not exceed the limit by 10 %, then the length test passes even if other pairs exceed the limit. This is the 10 % rule for length, as given in the ANSI/TIA-1152 standard. See the Fluke Networks Knowledge base for details.

A 2 % to 5 % difference in measured lengths of wire pairs in a cable is normal for these reasons:

- Signals travel at slightly different speeds in each wire pair, but the tester uses the same NVP to calculate the length of each pair.

- The twist rate varies slightly among wire pairs. If you untwist and straighten all the pairs, they will have slightly different lengths.

Differences between measured and actual lengths can be caused by variations in the cable's NVP value. NVP values can vary among cable types, lots, and manufacturers. In most cases, these differences are minor and may be ignored.

Propagation delay is the time taken for a test pulse to get to the end of a wire pair. The delay is measured in nanoseconds. One nanosecond is one-billionth of a second, or 0.000000001 second.

Propagation delays vary slightly among pairs because of small differences in electrical characteristics and length. The tester uses the propagation delay for each pair and the NVP for the cable type to calculate the length of each pair. The tester subtracts the propagation delays for the link interface adapters, so the length results do not include the length of the cables on the permanent link adapters.

Delay skews are the differences in propagation delays between the shortest delay and the delays of the other wire pairs. The shortest delay shows as "0" in the delay skew results.

Refer to Figure 26:

- ① **PROPAGATION DELAY:** The time taken for a test pulse to get to the end of a wire pair.
- ② **DELAY SKEW:** The differences in propagation delays between the shortest delay and the delays of the other wire pairs. The shortest delay shows as "0" in the delay skew results.
- ③ The tester shows a limit for propagation delay and delay skew if the measurements are required by the selected test limit. For measurements not required, the limit shows as **N/A**.

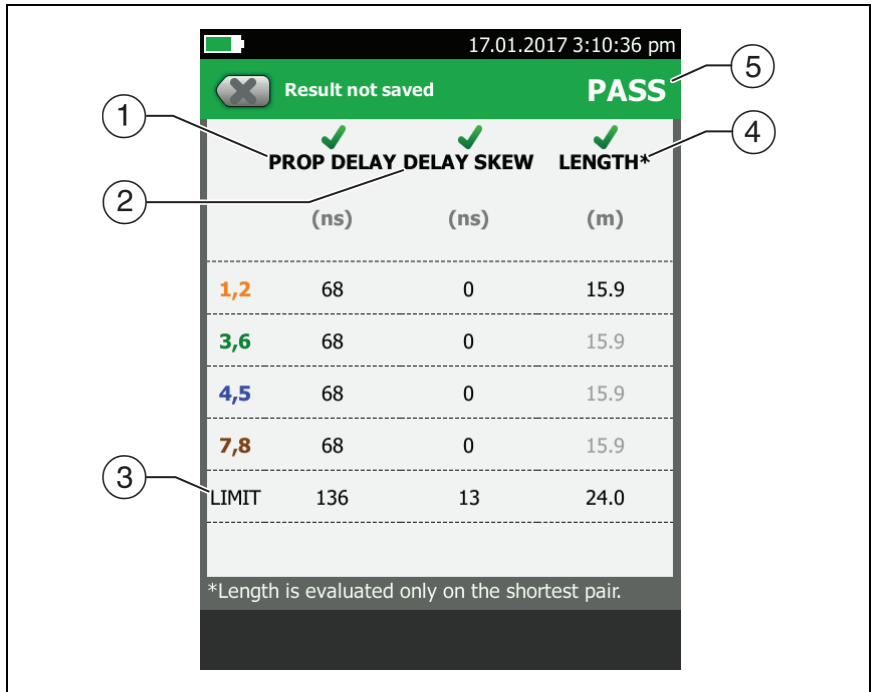

GPU68.EPS

Figure 26. Twisted Pair Length Results

Note

You can also measure length continuously. See "Continuous Tests" on page 70.

- ④ The tester uses the propagation delay for each pair and the NVP for the cable type to calculate the length of each pair. The tester compares the length of the shortest pair to the limit, and gives the test a **PASS** result if the pair is not too long. The lengths of the other pairs are gray on the screen.
- ⑤ The tester gives a **PASS** result if the shortest length and the longest delay skew do not exceed their limits.

Loop Resistance

Loop Resistance results show the DC loop resistance for each wire pair. The remote puts a short at the end of each pair to make the loops. A pair's resistance depends on the quality of the contacts in the connector, the length of the pair, and its wire gauge. Figure 27 shows the loop resistance results screen.

Resistance problems always affect other tests. For example:

- A link that is too long has too much resistance and will fail the length test.
- High-resistance connections reflect signals, which causes the return loss test to fail. Use the tester's HDTDR analyzer to see the distance to the bad connection.

Refer to Figure 27:

- ① **VALUE** is the DC loop resistance for each pair.
- ② **LIMIT** shows only if the selected test limit includes a limit for the loop resistance test.
- ③ The overall result for the loop resistance test. This result is for a test with the **ISO11801 Channel Class Ea** limit, which has a limit for the loop resistance test. Some test limits do not have a limit for this test. When no limit is available, the tester shows an .

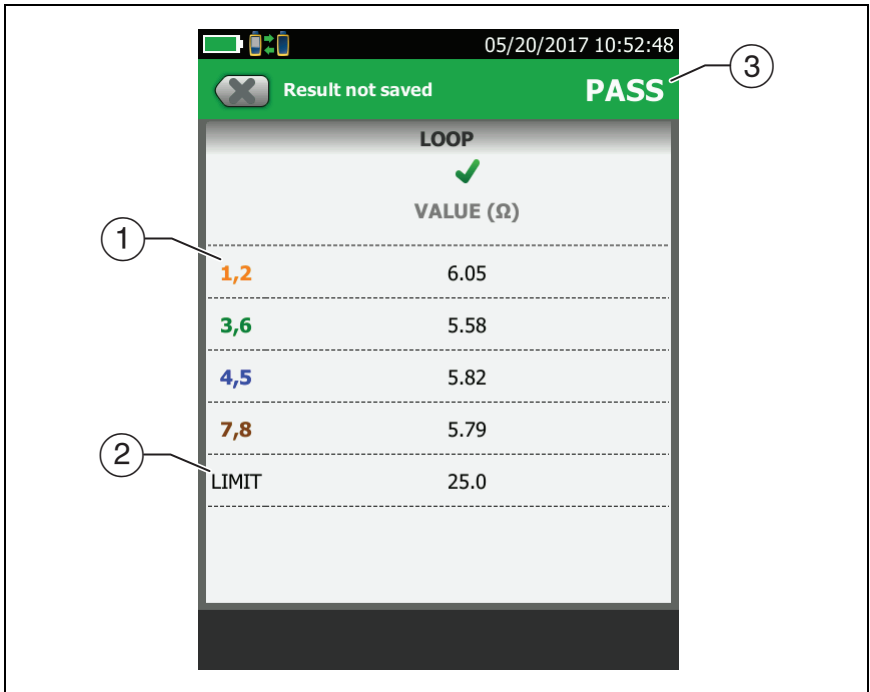

BA69.EPS



Figure 27. Twisted Pair Resistance Results

Note

You can also measure resistance continuously. See "Continuous Tests" on page 70.

Continuous Tests

To do the wire map, length, or resistance test continuously, go to the home screen, tap **TOOLS** > **Single Tests**, then tap a test.

The wire map test compares the cable connections to the outlet configuration specified by the selected test limit and shows  if the connections agree or  if they do not.

The length and resistance tests do not compare the results to a test limit.

To save the result, tap **SCAN OFF** > **SAVE**. The saved test has an  for the overall result.

Frequency-Domain Results

Frequency-domain results are the measurements that change with frequency, such as insertion loss and crosstalk. Figure 28 shows an example of results from a frequency-domain test.

How to Save Frequency-Domain Results as a Plot or a Table

If **Store Plot Data** is on when you do a test, the saved results show as plots. If **Store Plot Data** is **Off**, the tester does not save plot data for frequency-domain tests or for the HDTDR/HDTDX analyzers. You can see the plots before you save the test and exit the results screen. Figures 28 and 29 show examples of the two types of screens. Also see “Store Plot Data” on page 51.

Refer to Figure 28:

- ① The location of the measurements. To switch between results for the main and remote, tap **REMOTE** or **MAIN** (⑦).
- ② Measured values for the wire pairs.
- ③ The limit line (in red) for the measurement.

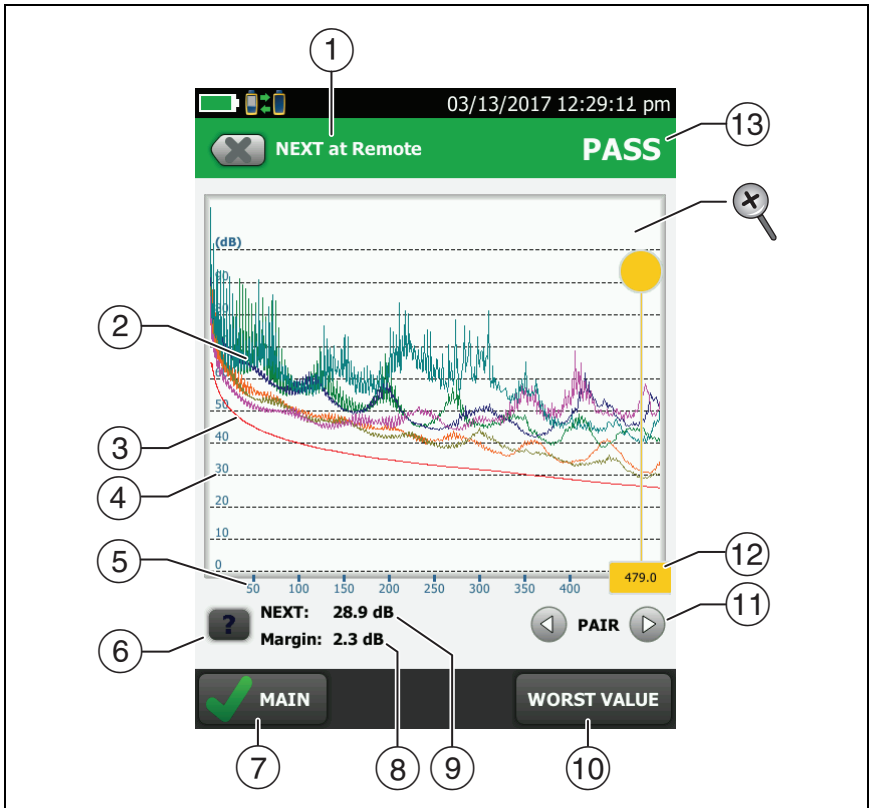





BA71.EPS

Figure 28. Plot Screen for a Frequency-Domain Test



Note

If the limit line is black, the tester does not evaluate the measurement at those frequencies because a dB rule applies. See "About dB Rules" on page 90.

- ④ The vertical scale is the measured value in decibels.
- ⑤ The horizontal scale is the frequency range in megahertz.
- ⑥ To see help for the screen, tap .

- ⑦ To switch between results for the main unit and the remote, tap **REMOTE** or **MAIN**.
- ⑧ The margin at the cursor's location. The margin is the difference between the measured value and the limit. The margin is negative if the pair failed.
- ⑨ The measured value at the cursor's location.
- ⑩ When you first look at the plot, the cursor is at the frequency of the worst margin. To move the cursor to the worst value, tap **WORST VALUE**. (The insertion loss plot is different. See "Insertion Loss" on page 74.)
- ⑪ To see the plots for pairs, tap  or . To select pairs to show on the plot, touch  or  for one second to see the **SELECT PAIRS** window. Select the pairs you want to see, then tap **OK**.
- ⑫ When you first look at the plot, the cursor is at the frequency of the worst margin. To move the cursor to the worst value, tap **WORST VALUE** (⑩). The box at the bottom of the cursor shows the frequency at the cursor's position.

To move the cursor to other points, touch and drag the yellow circle at the top of the cursor

To move the cursor in small increments, tap the yellow circle, then tap the arrow buttons that show on the plot ( or .
- ⑬ The overall result for the test. If you look at pairs, the result is for those pairs. If the result shows an asterisk, see "PASS*/FAIL* Results" on page 58.
-  To zoom in and out, use the pinch, reverse-pinch, and double-tap gestures on the touchscreen. You can also use the zoom controls to change the magnification on the frequency and decibels scales independently. See Figure 5 on page 20.

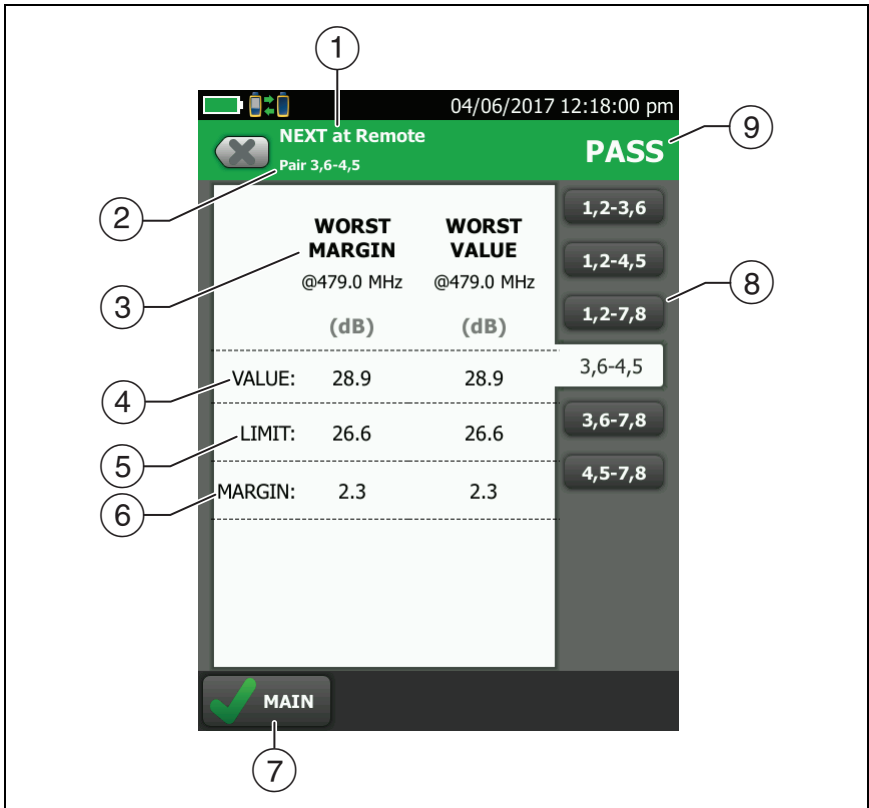

BA104.EPS

Figure 29. Tabular Results Screen for a Frequency-Domain Test

- ① The location where the tester made the measurements. To switch between results for the main and remote, tap **REMOTE** or **MAIN** (⑦).
- ② The results are for the wire pair or pairs shown. To see the results for a different pair or pairs, tap a tab on the right side of the screen (⑧).
- ③ **WORST MARGIN** is the measurement that is nearest to the limit line or exceeds the limit by the largest amount. **WORST VALUE** is the worst measurement.

- ④ The measured value.
- ⑤ The limit specified by the selected test limit.
- ⑥ **MARGIN** is the difference between the measured value and the limit. The value is negative and is in a red box if the measurement exceeds the limit.
- ⑦ To switch between results for the main unit and the remote, tap **REMOTE** or **MAIN**.
- ⑧ To see the results for a different pair or pairs, tap a tab.
- ⑨ The result for the pair. If the result shows an asterisk, see “PASS*/ FAIL* Results” on page 58.

Insertion Loss

Insertion loss is the loss of signal strength over the cabling, as shown in Figure 30. Insertion loss is caused by the DC resistance of the copper wire and connecting hardware, the impedance of the twisted pairs, and by leakage of electrical energy through the cable’s insulation. Lower values of insertion loss mean better cabling performance.

At higher frequencies, signals tend to travel only near the surface of a conductor. This “skin effect”, along with the cabling’s inductance and capacitance, cause insertion loss to increase with frequency.

Figure 31 shows the insertion loss plot. If the insertion loss test passed, the tester puts the cursor at the worst value. If the test failed, the cursor is at the worst margin.

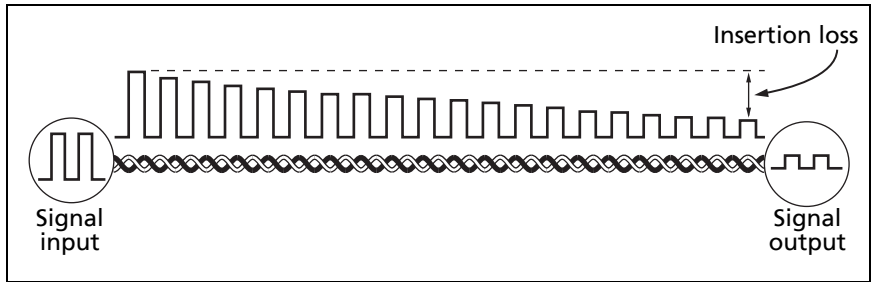

GPU81.EPS

Figure 30. Insertion Loss is a Decrease in Signal Strength

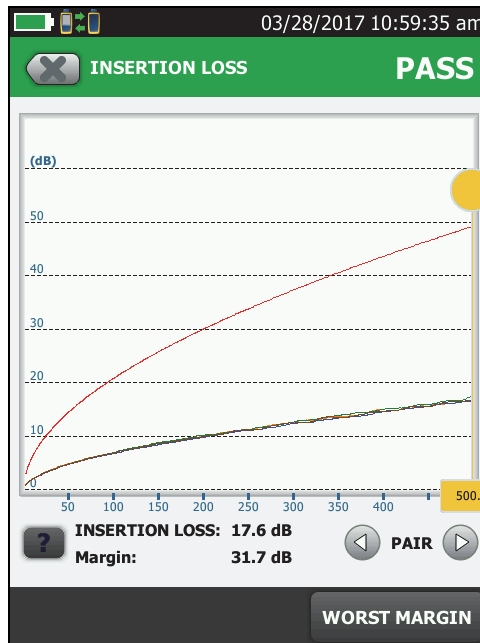

BA70.PNG

Figure 31. Twisted Pair Insertion Loss Plot

Return Loss

Return loss is the difference (in dB) between the power of a transmitted signal and the power of the signals reflected back. The signal reflections are caused by variations in the cable's impedance. Figure 32 shows some common sources of reflections that create return loss.

High return loss means the cabling reflects very little of the transmitted signal back to the source. High return loss is especially important for high-speed systems, such as Gigabit Ethernet. The bi-directional (full-duplex) transceivers used in these systems use directional couplers to distinguish between incoming and outgoing signals. The couplers may interpret strong reflected signals as incoming data, resulting in data errors.

A return loss plot indicates how well a cable's impedance matches its rated impedance over a range of frequencies. Figure 33 shows the return loss plot. The tester puts the cursor at the worst margin.

For return loss failures, you can use the HDTDR analyzer plot to locate the cause of the failure. See "The HDTDR Analyzer" on page 127.

Note

Because the 3 dB rule applies to return loss results, the result is usually an . See "About dB Rules" on page 90.

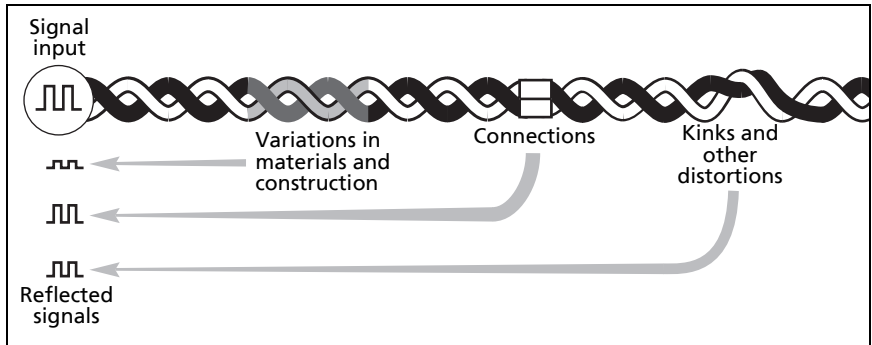

GPU84.EPS

Figure 32. Sources of Return Loss

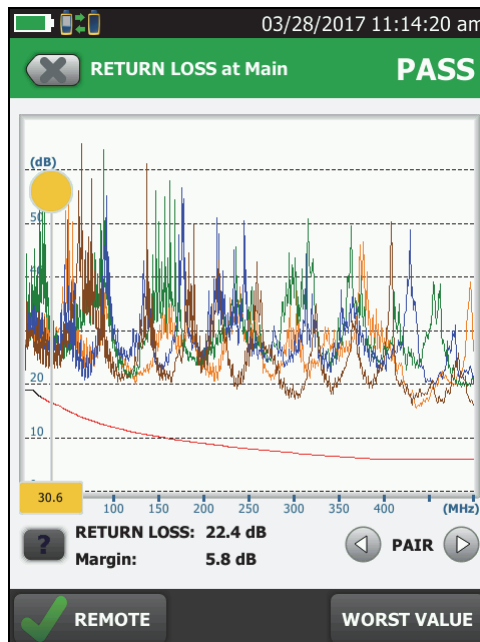

BA77.PNG

Figure 33. Return Loss Plot

Impedance

Notes

*Most test limits do not require the impedance measurement. For these limits, the tester does not make the measurement or it shows an **i** for the result. For cables shorter than approximately 13 ft (4 m), the tester shows **Cable too short** for the impedance measurement.*

Impedance results show the approximate characteristic impedance of each wire pair. Figure 34 shows the impedance results.

Characteristic impedance is the impedance a cable would have if the cable were infinitely long. Correct operation of the network depends on constant characteristic impedance throughout the system's cables and connectors. Sudden changes in characteristic impedance, called anomalies, cause signal reflections that can cause network faults.

	MIN Ω	VALUE Ω	MAX Ω
1,2	85	99	105
3,6	85	100	105
4,5	85	99	105
7,8	85	98	105

Figure 34. Twisted Pair Impedance Results

GPU158.PNG

NEXT (Near-End Crosstalk)

NEXT results show the crosstalk attenuation between wire pairs. NEXT is the difference in amplitude (in dB) between a transmitted signal and the crosstalk received on other wire pairs at the same end of the cabling. Higher NEXT values correspond to larger differences between the amplitudes of the transmitted signals and the crosstalk, which corresponds to better cabling performance. Figure 35 shows the NEXT plot. The tester puts the cursor at the worst margin.

Note

*If the NEXT result is an an **i**, the 4 dB rule applies.
See “About dB Rules” on page 90.*

Because of insertion loss, crosstalk signals occurring farther from the signal source are weaker and cause less trouble than crosstalk nearer the source (Figure 35). For this reason, the tester measures NEXT from both ends of the cabling.

For NEXT failures, you can use the HDTDX analyzer plot to locate cause of the failure. See “The HDTDR Analyzer” on page 127.

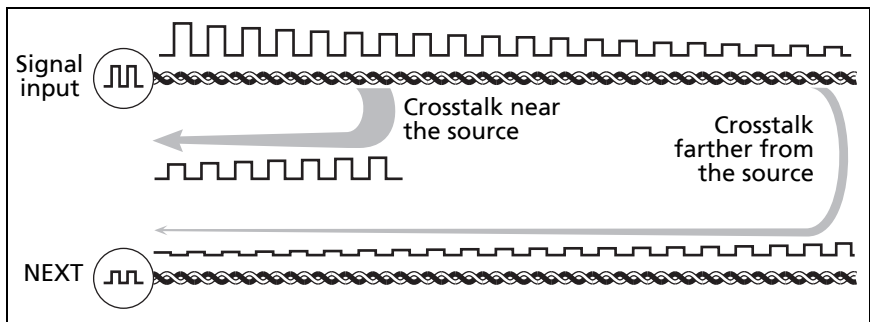

GPU82.EPS

Figure 35. Near-End Crosstalk (NEXT)

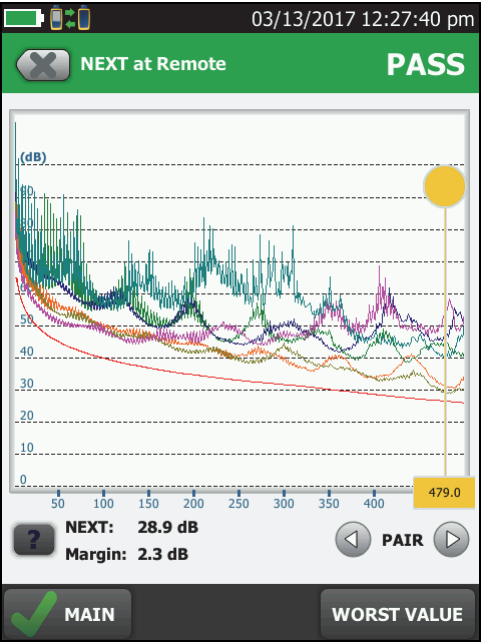

BA71.PNG

Figure 36. NEXT Plot

PS NEXT (Power Sum Near End Crosstalk)

PS NEXT results show how much each wire pair is affected by the combined crosstalk from the other pairs. PS NEXT is the difference (in dB) between the test signal and the crosstalk from the other pairs received at the same end of the cabling. The tester uses the NEXT values to calculate PS NEXT. Higher PS NEXT values correspond to better cabling performance.

PS NEXT results are typically a few dB lower (worse) than worst-case NEXT results. Figure 37 shows the PS NEXT plot. The tester puts the cursor at the worst margin.

Note

*If the PS NEXT result is an an **i**, the 4 dB rule applies. See "About dB Rules" on page 90.*



Figure 37. PS NEXT Plot

BA105.PNG

ACR-N (Attenuation to Crosstalk Ratio at the Near End)

ACR-N is like a signal-to-noise ratio. ACR-N values indicate how the amplitude of signals received from a far-end transmitter compares to the amplitude of crosstalk produced by near-end transmissions, as shown in Figure 38. The tester calculates ACR-N as the difference (in dB) between NEXT and insertion loss. Higher ACR-N values mean that received signals are much larger than crosstalk signals. Higher ACR-N values correspond to better cabling performance.

Figure 39 shows the ACR-N plot. The tester puts the cursor at the worst margin.

Note

If the ACR-N result is an **i**, the 4 dB rule applies.
See "About dB Rules" on page 90.

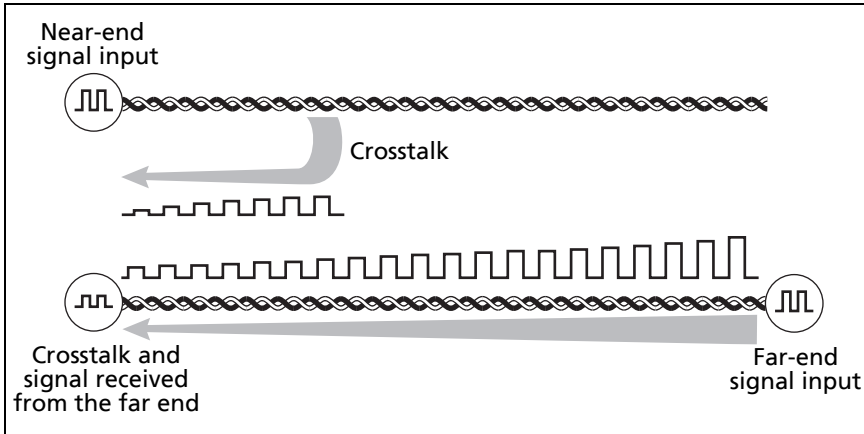
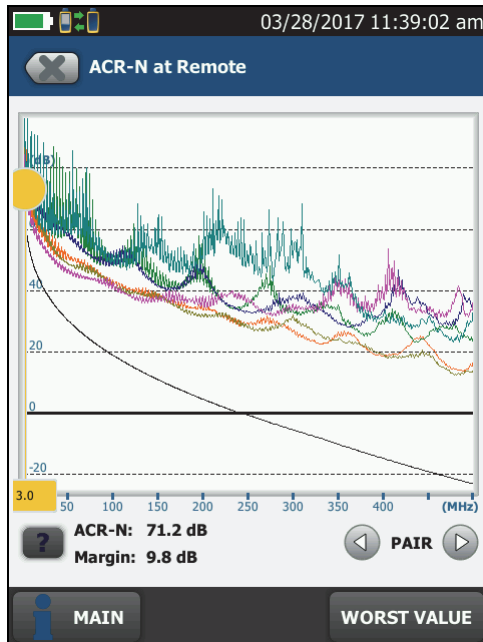

Figure 38. Attenuation to Crosstalk Ratio, Near End (ACR-N)

GPU83.EPS



BA73.PNG

Figure 39. ACR-N Plot

PS ACR-N (Power Sum Attenuation to Crosstalk Ratio, Near End)

PS ACR-N values show how the amplitude of signals received from a far-end transmitter compares to the combined amplitudes of crosstalk produced by near-end transmissions on the other wire pairs. PS ACR-N is the difference (in dB) between PS NEXT and attenuation (insertion loss). The tester uses the PS NEXT and attenuation results to calculate PS ACR-N values. Higher PS ACR-N values mean received signals are much larger than the crosstalk from all the other wire pairs. Higher PS ACR-N values correspond to better cabling performance.

PS ACR-N is the difference (in dB) between each wire pair's attenuation (insertion loss) and the combined crosstalk received from the other pairs. The tester uses the PS NEXT and attenuation values to calculate PS ACR-N values.

PS ACR-N results are typically a few dB lower (worse) than worst-case ACR-N results. Figure 40 shows the PS ACR-N plot. The tester puts the cursor at the worst margin.

Note

If the PS ACR-N result is an an , the 4 dB rule applies. See "About dB Rules" on page 90.

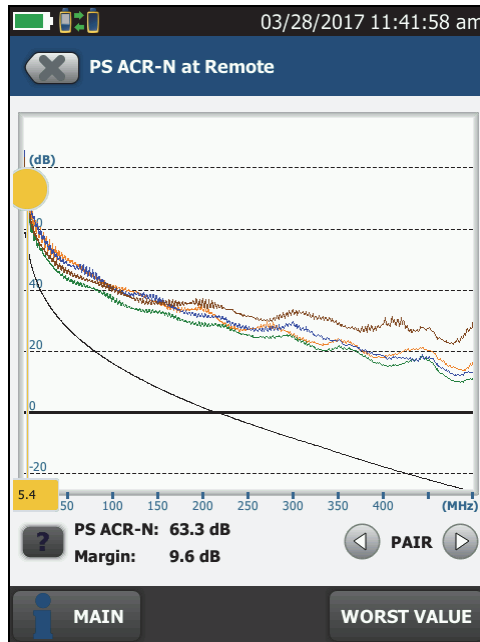

BA106.PNG

Figure 40. PS ACR-N Plot

ACR-F (Attenuation to Crosstalk Ratio, Far End)

While NEXT is measured at the same end as the signal source, FEXT (far-end crosstalk) is measured at the far end. Because all far-end crosstalk signals travel the same distance, they experience the same amount of attenuation, as shown in Figure 41. This means that all crosstalk signals contribute equally to noise at the far end. This is different from near-end crosstalk. At the near end, crosstalk occurring closer to the source contributes more to noise than crosstalk occurring farther from the source.

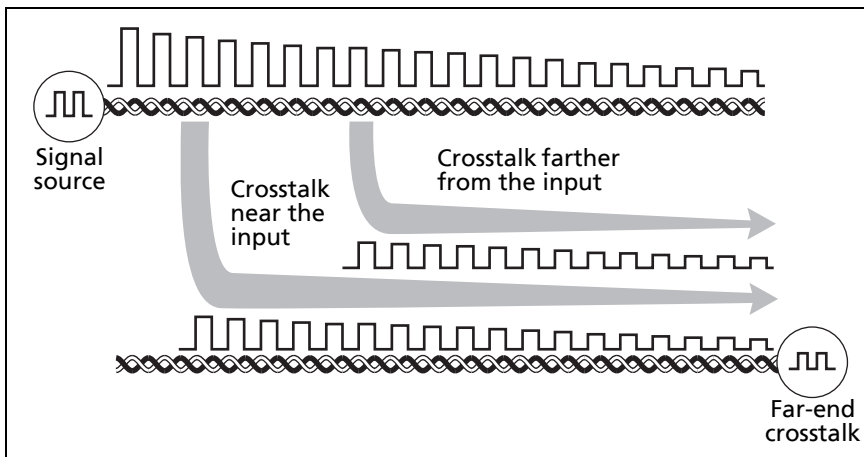

Figure 41. Far-End Crosstalk (FEXT)

GPU66.EPS

Because of attenuation, FEXT on longer cables is less than FEXT on shorter cables of the same type. Subtracting the effects of attenuation normalizes the results for length and produces ACR-F (attenuation to crosstalk ratio, far end) values. Because ACR-F does not depend on length, it is used instead of FEXT to evaluate cable performance.

Because all far-end crosstalk signals travel the same distance, they tend to add up in phase. Therefore, high ACR-F is critical when two or more wire-pairs carry signals in the same direction. 1000BASE-T carries bi-directional signals on all four wire pairs, so ACR-F is a critical parameter for 1000BASE-T certification.

Like ACR-N, ACR-F represents a signal-to-noise ratio for the cabling. Higher ACR-F values mean that data signals received at the far end of the cabling are much larger than crosstalk signals received at the far end. Higher ACR-F values correspond to better cabling performance. Figure 42 shows the ACR-F plot. The tester puts the cursor at the worst margin.

Note

*If the ACR-F result is an **i**, the 67 dB rule applies. See "About dB Rules" on page 90.*

NEXT and ACR-F performance tends to be similar in cable, but may differ greatly in connecting hardware. Some connectors achieve good NEXT performance by balancing the inductive and capacitive currents that cause crosstalk. Because these currents are 180° out of phase at the near-end of the cabling, they cancel out, which eliminates crosstalk at the near end. However, currents that cancel at the near end add up at the far end, causing far-end crosstalk and poor ACR-F performance.

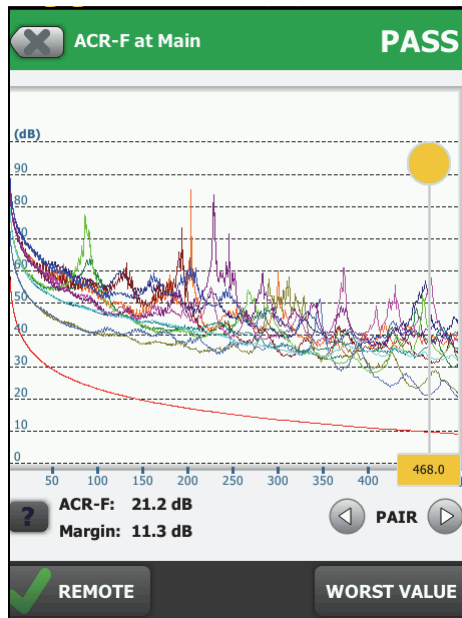

Figure 42. ACR-F Plot

BA75.PNG

PS ACR-F

PS ACR-F results show how much the far end of each wire pair is affected by the combined far-end crosstalk from the other pairs. PS ACR-F is the difference (in dB) between the test signal and the crosstalk from the other pairs received at the far end of the cabling. The tester uses the ACR-F values to calculate PS ACR-F. PS ACR-F results are typically a few dB lower than worst-case ACR-F results. Higher PS ACR-F values correspond to better cabling performance. Figure 43 shows the PS ACR-F plot. The tester puts the cursor at the worst margin.

Note

If the PS ACR-F result is an **i**, the 67 dB rule applies. See "About dB Rules" on page 90.

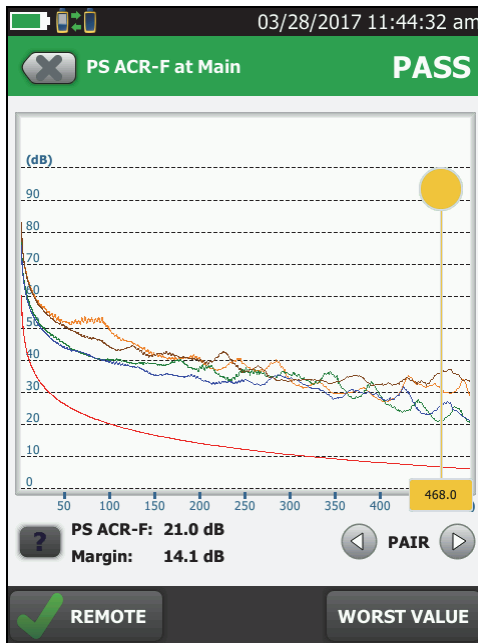

Figure 43. PS ACR-F Plot

BA107.PNG

DIAGNOSTIC Tab

If an Autotest on twisted pair cabling fails or has marginal results, the DSX-600 CableAnalyzer automatically gives you HDTDR and HDTDX plots to help you find faults. To see the plots, tap the **DIAGNOSTIC** tab, then tap the HDTDR or HDTDX panel (Figure 44).

To get only diagnostics results, select **Diagnostics** from the **TOOLS** menu. These results do not include a **PASS/FAIL** status.

For more information on the HDTDR and HDTDX plots, see the Technical Reference Handbook.

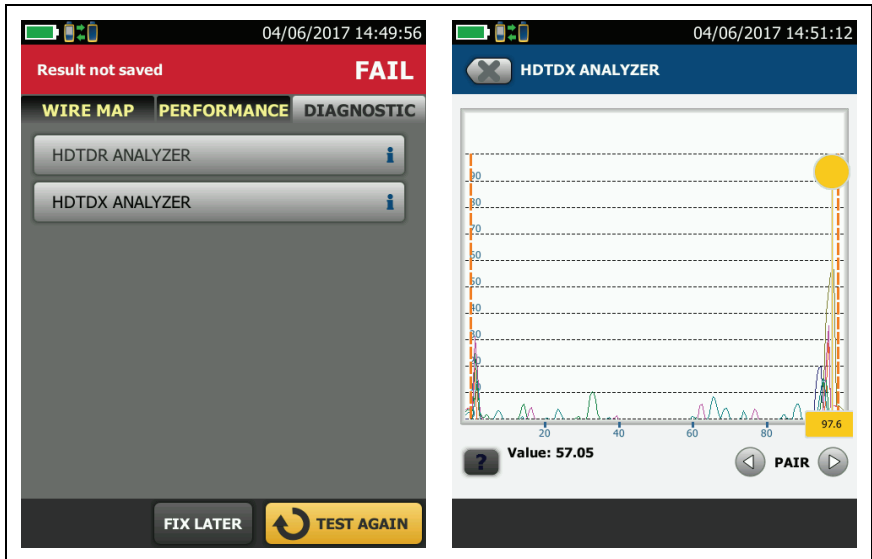

BA192.EPS

Figure 44. Examples of Diagnostic Screens

About dB Rules

For some test limits, the tester ignores the PASS/FAIL result from some tests when a measurement is less than a specified value. For example, the return loss measurement is not evaluated against the limit at frequencies where insertion loss is less than 3 dB. This is the 3 dB rule.

When a measurement is not evaluated against a limit, the tester shows an **i** for the result. On the plot for that measurement, the limit line is black where the result is not evaluated against the limit, as shown in Figure 45. When you upload the results to LinkWare PC, **N/A** shows for the result.

The next sections summarize the dB rules. Tables 3 and 4 show the dB rules that apply to each test and the test limits that use the rules. For more information, see the Knowledge Base on the Fluke Networks website.

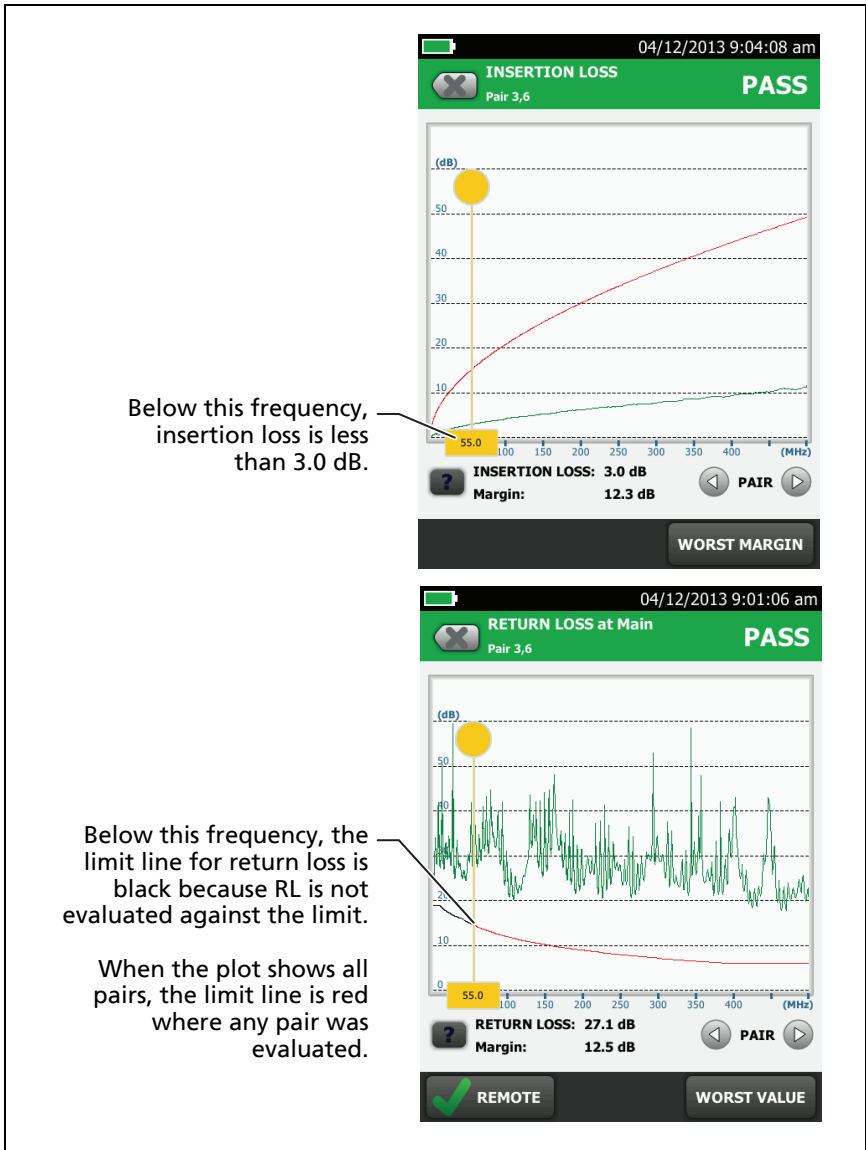

GPU58.EPS

Figure 45. How the 3 dB Rule Shows on Plots

3 dB Rule

At frequencies where insertion loss is less than 3.0 dB for a pair, return loss for that pair is not evaluated against a limit. See Tables 3 and 4 for applicable limits.

4 dB Rule

This rule applies to these ISO limits:

- ISO/IEC 11801
- EN 50173
- Aus/NZ
- JIS

At frequencies where insertion loss is less than 4.0 dB for the pair used as the receive pair for the test, the measurements shown in Table 4 are not evaluated against a limit.

12 dB Rule

This rule applies to these ISO test limits:

- ISO11801 Channel Class E_A
- ISO11801 PL Class E_A

If insertion loss at 450 MHz is less than 12 dB for both pairs, the tester uses a relaxed limit for NEXT. If the standard and relaxed limits both apply to a plot, the plot shows both limit lines. See the Knowledge Base on the Fluke Networks website for details.

67 dB Rule for ACR-F and PS ACR-F

At frequencies where FEXT or PS FEXT is less than 67 dB, ACR-F or PS ACR-F are not evaluated against a limit. See Tables 3 and 4 for applicable limits.

70 dB Rule for ACR-F and PS ACR-F

These rules applies to all channel or permanent link test limits where ACR-F is measured.

At frequencies where FEXT or PS FEXT is less than 70 dB, ACR-F or PS ACR-F are not evaluated against a limit. See Tables 3 and 4 for applicable limits.

Table 3. dB Rules for TIA Test Limits









Measurement	Cat 5e/6/6A Permanent Link	Cat 5e/6/6A Channel
Return Loss ¹	3 dB	3 dB
ACR-F	67 dB ²	70 dB ³
1. If insertion loss is less than 3 dB, Return Loss measurements show an  . 2. If FEXT or PS FEXT is less than 67 dB, ACR-F and PS ACR-F measurements show an  . 3. If FEXT or PS FEXT is less than 70 dB, ACR-F or PS ACR-F measurements show an  .		

Table 4. dB Rules for ISO Test Limits

Measurement	Class D, E, E _A Permanent Link	Class D, E, E _A Channel
Return Loss ¹	3 dB	3 dB
NEXT/PS NEXT ²	4 dB	4 dB
ACR-N/PS ACR-N ²	4 dB	4 dB
ACR-F ³	70 dB	70 dB
PS-ACR-F	70 dB ⁴	67 dB ⁵
1. If insertion loss is less than 3 dB, Return Loss measurements show an  . 2. If insertion loss is less than 4 dB, these measurements show an  . 3. If FEXT is less than 70 dB, ACR-F measurements show an  . 4. If PS FEXT is less than 70 dB, PS ACR-F measurements show an  . 5. If PS FEXT is less than 67 dB, PS ACR-F measurements show an  .		

How to Use the Tone Generator

The tone generator on the main and remote lets you use a tone probe, such as the Fluke Networks IntelliTone™ probe, to locate cables or jacks. The tone probe converts the tone generator's signal to audible tones. The tones get louder as you move the probe closer to the cable or jack connected to the tester. The main tester can transmit four different tones.

Note

The tone generator does not generate the IntelliTone signal.

The tone generator also turns on an inactive main or remote DSX CableAnalyzer connected to the other end of the cable.

To use the tone generator

- 1 Attach a link interface adapter to the main or remote tester.
- 2 Connect the tester to a cable.
- 3 Turn on the tone generator:
 - Main tester: Press TEST or tap **TOOLS > Tone Generator**. To change the tone, tap **CHANGE TONE**.
 - Remote tester: Press TEST.
- 4 Use a tone probe to locate the cable or jack that transmits the tone.

Notes

A tone probe possibly cannot detect the tone generator's signal along shielded cable, but can detect the signal at the cable's jack.

If you connect a tester to the other end of the cable, the tone generator turns off.

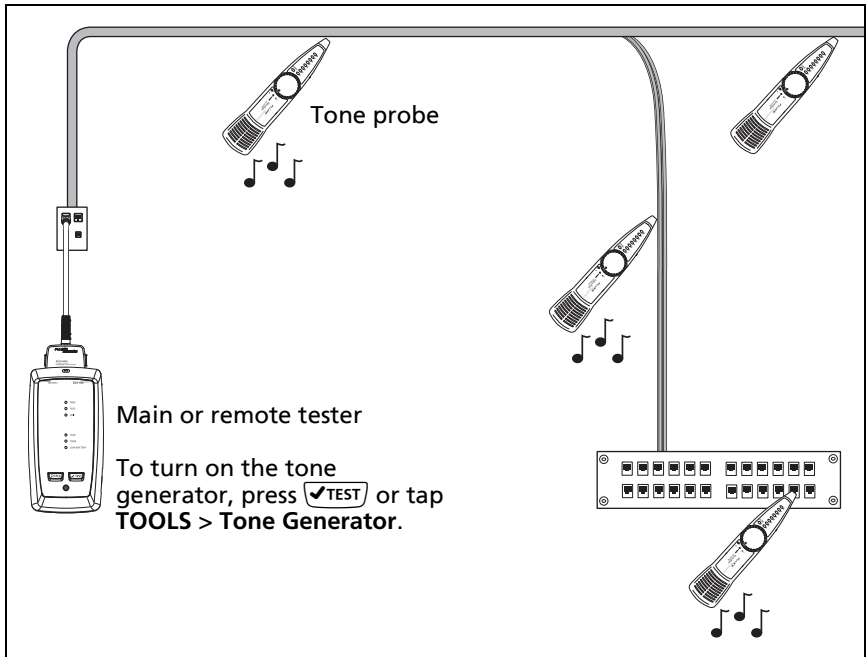

Figure 46. How to Use the Tone Generator

How to Use the Talk Function

If you have two DSX-600 testers, you can use the talk function to talk to the person at the other end of a twisted pair link.

Note

The talk mode does not operate during tests.

To use the talk function

- 1 Connect the main and remote testers together through a link that has one or more good wire pairs.
- 2 Connect headsets to the headset jacks on the testers.

-continued-

- 3 Press the button on one of the headset microphones or press  on the remote tester, then speak into the microphone.

When the talk function is on,  shows at the top of the screen on the main tester. On the remote tester, the **TALK** LED is on.

- 4 To adjust the volume at the main tester, press the button on the headset's microphone as necessary, or move the slider control in the **Talk Enabled** window.

To adjust the volume at the remote tester, press  or the button on the headset's microphone as necessary. The LEDs on the remote show the volume level.

- 5 To turn off the talk function, hold down the button on one of the headsets or hold down  on the remote tester.

Chapter 4: Test Twisted Pair Through a PoE Device

The AC wire map test lets you see the wire maps of links connected through midspan PoE (Power over Ethernet) devices. Midspan PoE devices block the DC signals the tester uses to do the wire map test. When you turn on the AC wire map test, the tester uses AC signals instead of DC signals for the wire map test. This setting does not change how the tester does other tests.

How to Turn On the AC Wire Map Test

- 1 On the home screen, tap the test setup panel.
- 2 On the **CHANGE TEST** screen, select a twisted pair test to change, then tap **EDIT**.
- 3 On the **TEST SETUP** screen, tap the **AC Wire Map** control to set it to **On**.
- 4 Tap **SAVE**.

When the **AC Wire Map** test is on, this icon shows on the home screen: 

When to Keep the AC Wire Map Test Off

- Turn off the AC wire map test when you do not do tests through PoE devices. The test can increase the time taken for an Autotest.
- Turn off the AC wire map test when you select TIA Cat 6 or 6A or Class E or E_A limits. The return loss test on PoE devices will always fail with these limits because PoE devices are not designed to operate with protocols above 1000BASE-T. To use those limits on a link that has PoE, do not do tests through the PoE device.

- Turn off the AC wire map test if the PoE device supplies power on pairs 4,5 and 7,8. In those devices, the inputs and outputs are fully isolated on those pairs. To do tests through those devices, use a PoE test limit such as **POE 2-Pair Cat 6 Perm. Link**. The PoE limits are in the **Application** group on the **TEST LIMIT** screen.

How to Do an Autotest Through a PoE Device

- 1 Turn on the **AC Wire Map** test.
- 2 Make sure that the other settings shown on the home screen are correct.
- 3 Connect to the cabling as shown in Figure 47 for a permanent link or Figure 48 for a channel
- 4 Make sure that the PoE device is turned off.
- 5 Do an Autotest as described on page 87.

Notes

When you turn on the AC wire map test:

- The Autotest takes more time.
- The tester does not do some tests, such the resistance test and the shield test.
- The Autotest does not stop if there is a wire map fault.
- The tester does not do a continuity test on the shield.

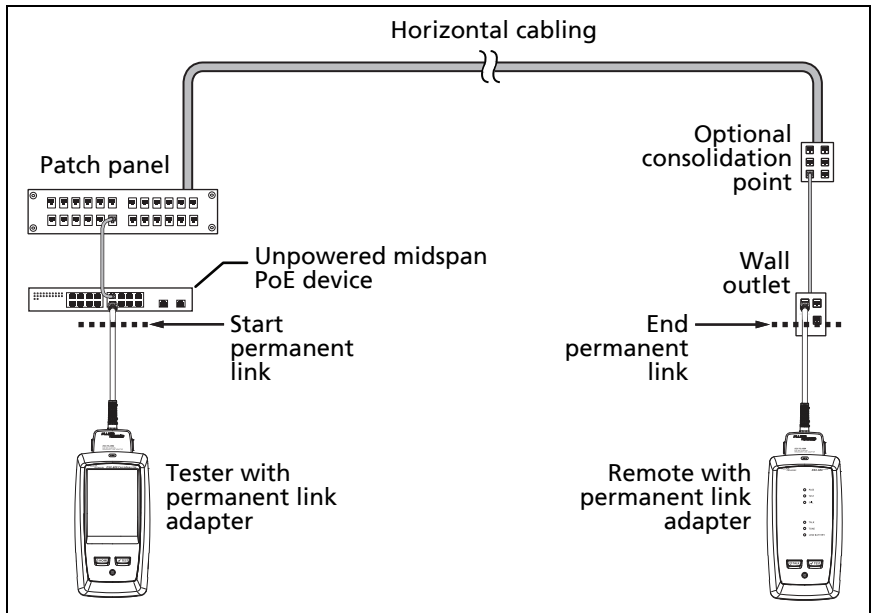

BA94.EPS

Figure 47. Permanent Link Connections Through a PoE Device

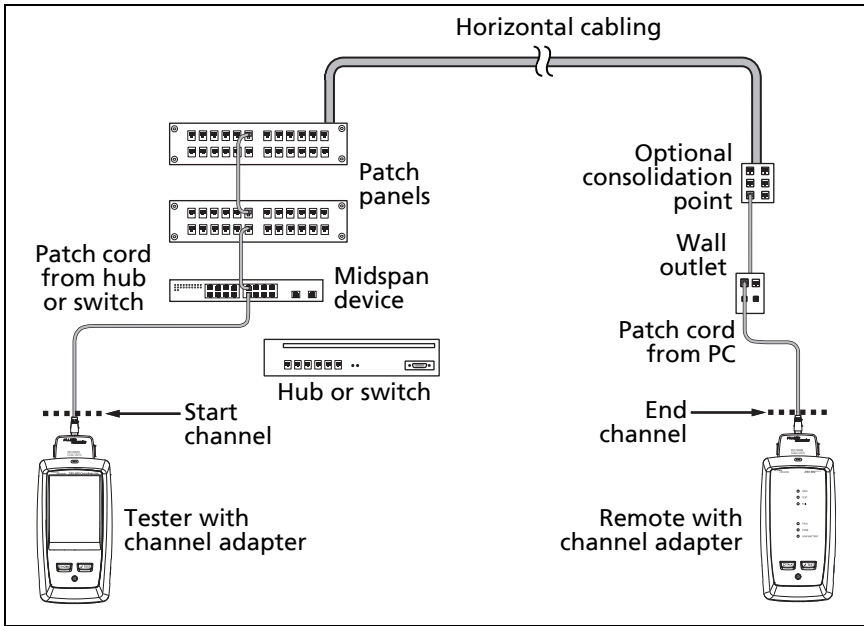

BA95.EPS

Figure 48. Channel Connections Through a PoE Device

AC Wire Map Results

AC wire map results are similar to the wire map results shown in Chapter 3. In some cases, the fault information given by AC wire maps is less specific. For example, if a wire is shorted to a wire in another pair, the AC wire map shows all four wires shorted. This occurs because the AC electrical characteristics of some faults prevent some types of measurements.

Figures 49 and 50 show examples of AC wire map screens.

When the tester cannot show the wire map because it has multiple faults, it shows a list of the faults (see Figure 50).

Note

To isolate faults when the tester shows limited wire map information, turn off the AC wire map test, then do tests on the cabling after the PoE device. Also do a test on the patch cord that connects the PoE device to the link.

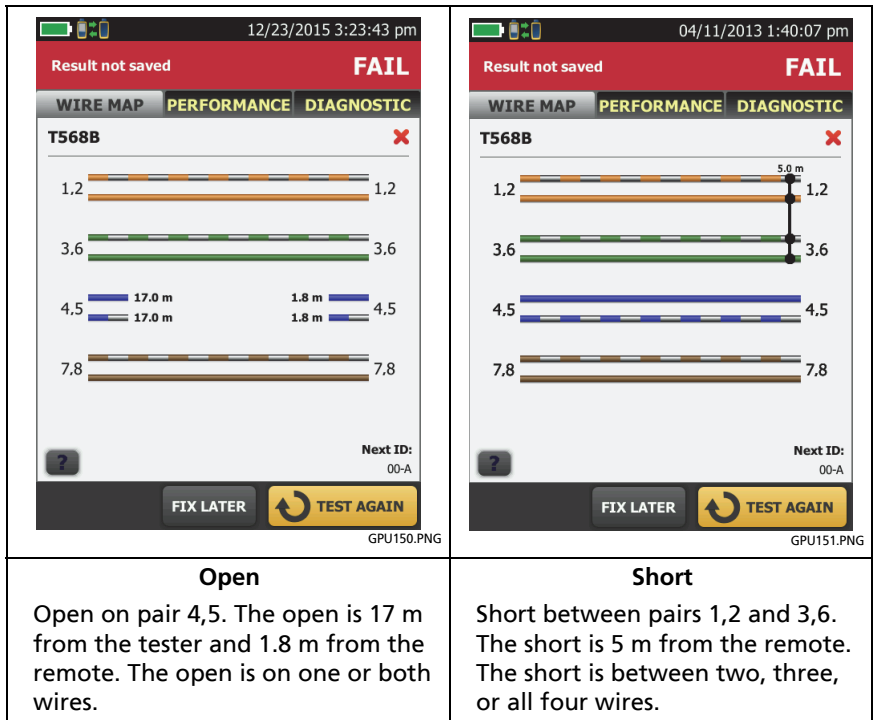

Figure 49. AC Wire Map Examples: Open and Short

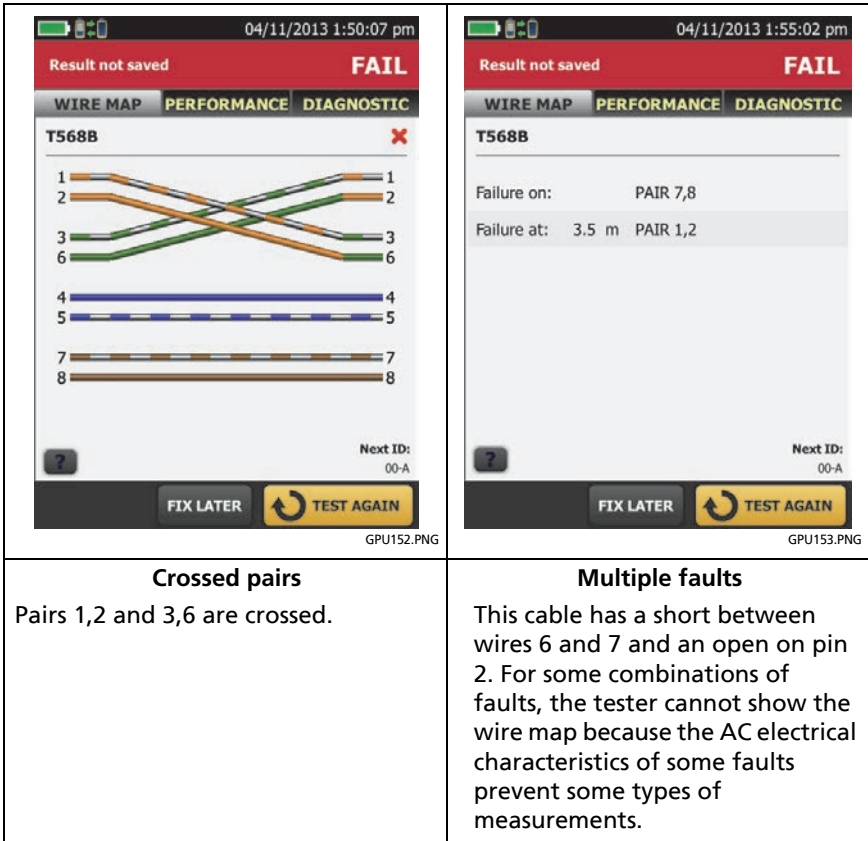

Figure 50. AC Wire Map Examples:

Chapter 5: Certify Coaxial Cabling

The optional DSX-CHA003 coaxial adapters let you use the DSX-600 CableAnalyzer to certify coaxial cabling for network and video applications.

Set the Reference for Coaxial Tests

To use DSX-CHA003 adapters, you must set the reference for coaxial tests. The reference procedure sets a baseline for insertion loss and resistance measurements.

Set the reference at these times:

- Every 30 days, at minimum.
- To ensure maximum accuracy of test results, set the reference daily.

Note

It is not necessary to set the reference again if you use different coaxial adapters.

To set the reference

- 1 Make the connections shown in Figure 51.
- 2 Turn on the tester and the remote a minimum of 5 minutes before you set the reference.

-continued-

Notes

Set the reference only after the testers are at an ambient temperature between 10 °C and 40 °C (50 °F and 104 °F).

The tester will not let you set the reference if the patch cord is longer than 30 cm (12 in).

You can also set the reference with a 50 Ω patch cord.

- 3 On the home screen, select a coaxial cable test.
- 4 On the home screen, tap **TOOLS**, then tap **Set Reference**.
- 5 On the **SET REFERENCE** screen tap **TEST**.

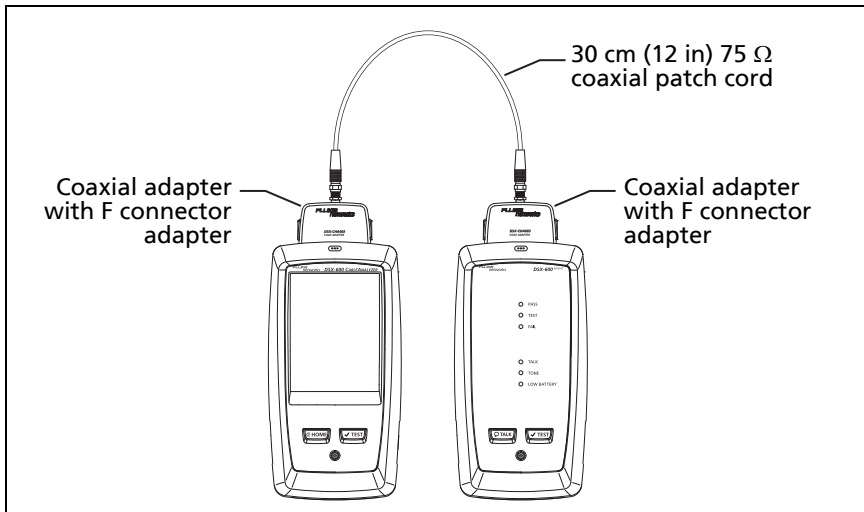

BA179.EPS

Figure 51. Reference Connections for Tests on Coaxial Cabling





Settings for Coaxial Tests

Table 5 gives descriptions of the settings for coaxial tests. To set up a project, which includes the settings in Table 5, cable IDs, and operator names, see Chapter 8.

To set up a coaxial test

- 1 On the home screen, tap the test setup panel.
- 2 On the **CHANGE TEST** screen, select a coaxial test to change, then tap **EDIT**.
Or to set up a new coaxial test, tap **NEW TEST**.
- 3 On the **TEST SETUP** screen, tap the panels to change settings for the test. See Table 5.
- 4 On the **TEST SETUP** screen, tap **SAVE** when your test setup is completed.
- 5 On the **CHANGE TEST** screen, make sure the button next to the test is selected, then tap **USE SELECTED**.

Table 5. Settings for Coaxial Tests

Setting	Description
Cable Type	Select a cable type that is correct for the type you will test. To see a different group of cable types, tap MORE , then tap a group. To make a custom cable type, see Chapter 10.
NVP	<p>Nominal velocity of propagation. The tester uses the NVP and the propagation delay to calculate the length of the cable.</p> <p>The default value is defined by the selected cable type and is the typical NVP for that cable type. To enter a different value, tap the NVP panel, then tap  or  on the NVP screen to increase or decrease the value.</p> <p>To find the actual value for a cable, connect a known length of the cable to the tester, tap MEASURE on the NVP screen, then change the NVP until the measured length matches the known length. Use a cable at least 30 m (100 ft) long.</p> <p>When you increase the NVP value, the calculated length increases.</p>
Test Limit	Select the correct test limit for the job. To see a different group of limits, tap MORE , then tap the name of a group.
Store Plot Data	<p>Off : The tester does not save plot data for insertion loss or for the HDTDR analyzer. You can see the plots before you save the test and exit the results screen. The saved results show insertion loss measurements in a table and do not include the HDTDR plot.</p> <p>On : The tester saves plot data for the insertion loss test and for the HDTDR analyzer.</p>

How to Do an Autotest

Figure 52 shows the equipment for tests on coaxial cabling.

Note

You can do the HDTDR, length, and resistance tests without a remote tester. See “Tests Without a Remote” on page 117.

- 1 Attach coaxial adapters to the main and remote testers.
- 2 Make sure that the home screen shows the correct settings for the job.

To make sure that other settings are correct, tap the test setup panel, make sure the correct test is selected on the **CHANGE TEST SCREEN**, then tap **EDIT** to see more settings. Table 5 on page 106 describes the settings.

- 3 Connect the testers to the link as shown in Figure 53.

Caution

To make sure your results are reliable:

- **Disconnect all taps and devices from the cable.**
- **Do not do tests through splitters (See “About Splitters” on page 117).**

- 4 Tap **TEST** on the main tester or press  on the main or remote tester.

If the tester at the other end of the cable is in sleep mode or is off, your tester’s tone generator turns on the other tester.

If the two testers are not connected:

- Your tester’s tone generator stays on so you can use a tone probe to find the cable to connect to the other tester.

- Or, tap **MEASURE** to do the length and resistance tests, which do not require a remote tester. Because the tester cannot complete all tests, and the reflection at the end of the cable exceeds the 15% limit for the HDTDR test, the result for an Autotest without a remote is always **FAIL**.

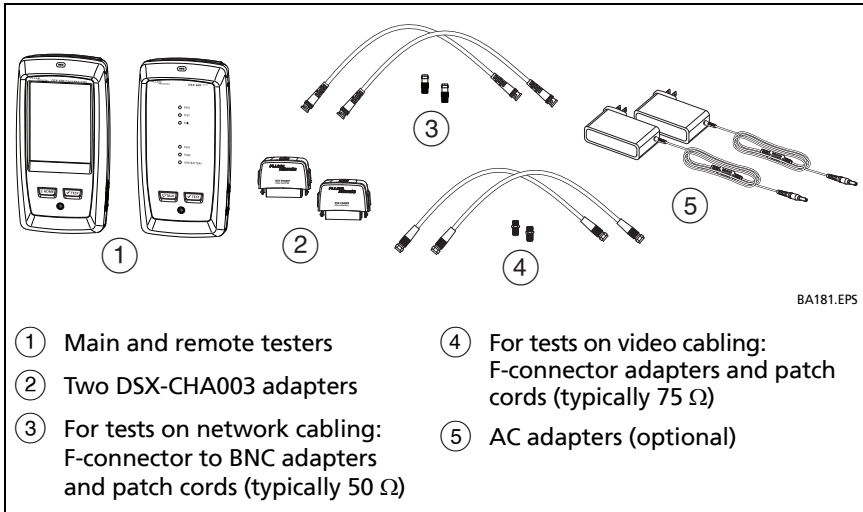
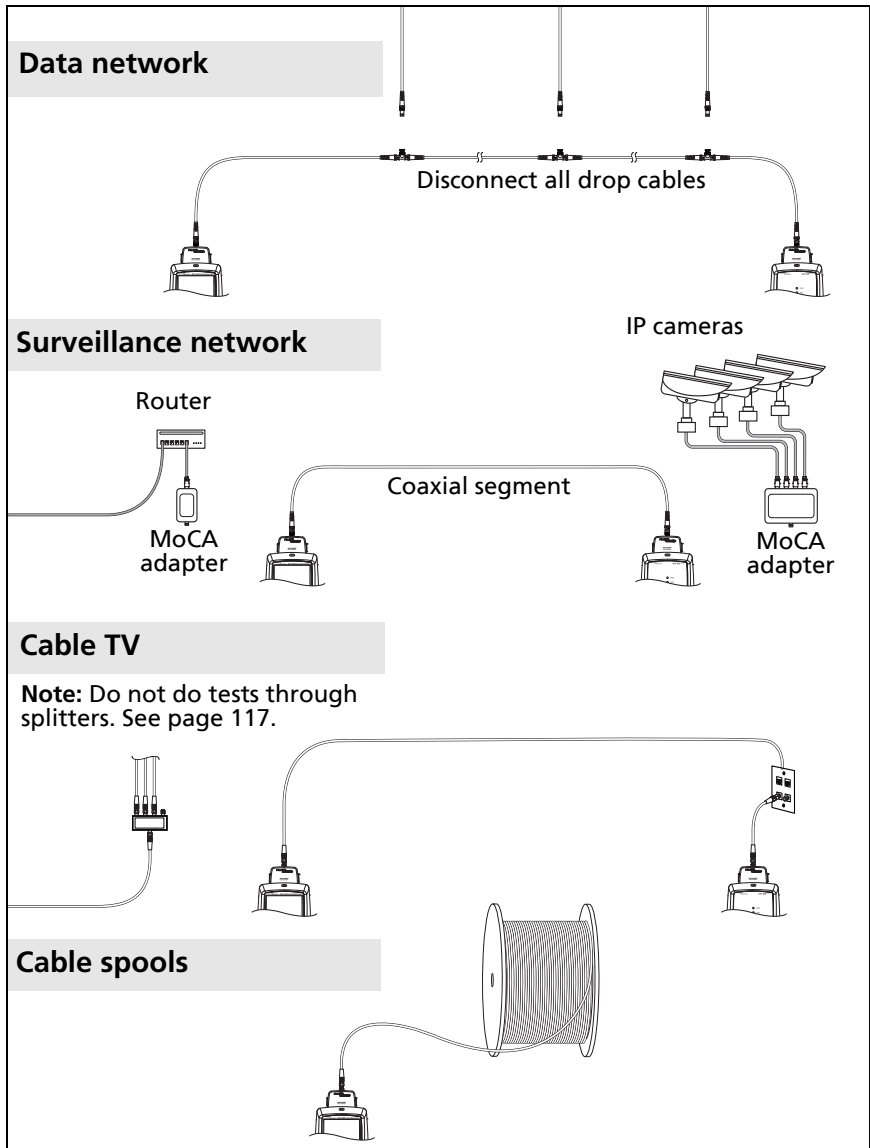

Figure 52. Equipment for Tests on Coaxial Cabling

Note

*If you have two main testers, you can use one as a remote. To select the remote function, tap **TOOLS** > **Main as Remote**.*



BA184.EPS

Figure 53. Examples of Connections for Tests on Coaxial Cabling

Coaxial Autotest Results

Note





Not all test limits include all the tests shown in Figure 54.



GPU182.EPS

Figure 54. Autotest Results for Coaxial Cabling

- ① The test limit and cable type used for the test.
- ② To see detailed results for a test, tap the panel.
- ③ The overall result for the Autotest. If the result shows an asterisk, See "PASS*/FAIL* Results" on page 94.

- ④ The **DIAGNOSTIC** tab shows the HDTDR analyzer button, which you can tap to see the HDTDR plot. The plot helps you find faults on the cable. The HDTDR plot for coaxial cable includes limit lines and a **PASS/FAIL** result. See “The HDTDR Analyzer” on page 127.
- ⑤ The overall result for the test:
 -  The results exceed the limit.
 -  The results are within the limit.
 -  The selected test limit does not have a limit for the test.
 -  The results are within the range of accuracy uncertainty for the tester. See “PASS*/FAIL* Results” on page 94.

The measurement shown for the insertion loss plot is the worst value if the test passed, or the worst margin if the test failed.
- ⑥ When more than one button shows at the bottom of the screen, the tester highlights one in yellow to recommend which one to tap. See “Buttons to Do Tests and Save Results” on page 36.

To do the resistance test continuously, select the test from the **TOOLS** menu. This function helps you locate intermittent faults.

Length and Propagation Delay

The length measurement shows the length of the center conductor in the cabling.

Differences between measured and actual lengths can be caused by variations in the cable's NVP value. NVP values can vary among cable types, lots, and manufacturers. In most cases, these differences are minor and may be ignored.

Propagation delay is the time taken for a test pulse to get to the end of the cable. The delay is measured in nanoseconds. One nanosecond is one-billionth of a second, or 0.000000001 second.

Figure 55 shows the results from a length test.

	PROP DELAY (ns)	LENGTH (ft)
Coax	35	27
LIMIT	1600	607

GPU185.PNG

Figure 55. Coaxial Length and Propagation Delay Results

Resistance

The resistance measurement is the DC loop resistance of the center conductor and the shield. The remote puts a short between the conductor and the shield to make the loop.

Most coaxial standards do not have a limit for resistance. The tester shows an **i** when there is no limit.

Note

*The resistance test on the **TOOLS > Single Tests** menu lets you measure resistance continuously. This function can help you locate intermittent faults.*

Figure 56 shows the results from a resistance test.

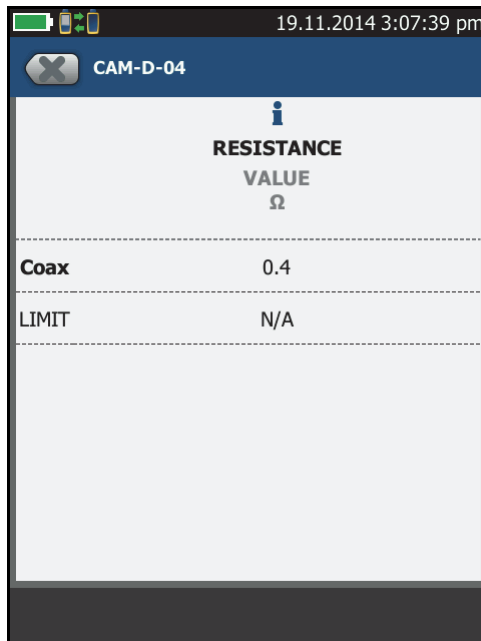

RESISTANCE	
VALUE	Ω
Coax	0.4
LIMIT	N/A

Figure 56. Coaxial Resistance Results

GPU186.PNG

Impedance

Note

*The minimum cable length for an impedance measurement is 13 ft (4 m). For impedance measurements on shorter cables, the tester shows **Cable too short**, and an **i** for the impedance and overall test results.*

The impedance measurement shows the approximate characteristic impedance of the cable at a point approximately 13 ft (4 m) from the tester.

Characteristic impedance is the impedance a cable would have if the cable were infinitely long. Good cabling has relatively constant characteristic impedance throughout the cable and connectors.

Changes in impedance cause signal reflections in cabling. In computer networks, signal reflections can cause network faults. In video systems, reflections can cause poor picture quality.

Figure 57 shows the results from an impedance test.

19.11.2014 3:08:00 pm

CAM-D-04 **PASS**

✓

IMPEDANCE

	MIN Ω	VALUE Ω	MAX Ω
Coax	42	51	58

GPU187.PNG

Figure 57. Coaxial Impedance Results

Insertion Loss

Insertion loss is the loss of signal strength over the cabling. Insertion loss is caused by the DC resistance of the copper wire and connecting hardware, the impedance of the conductor, and by leakage of electrical energy through the cable's insulation. Lower values of insertion loss mean better cabling performance.

At higher frequencies, signals tend to travel only near the surface of a conductor. This "skin effect", along with the cabling's inductance and capacitance, cause insertion loss to increase with frequency.

Figure 58 shows the results from an insertion loss test.

Note

For some test limits, such as the CATV and DS3 limits, the tester uses the measured length to calculate the limit for insertion loss.

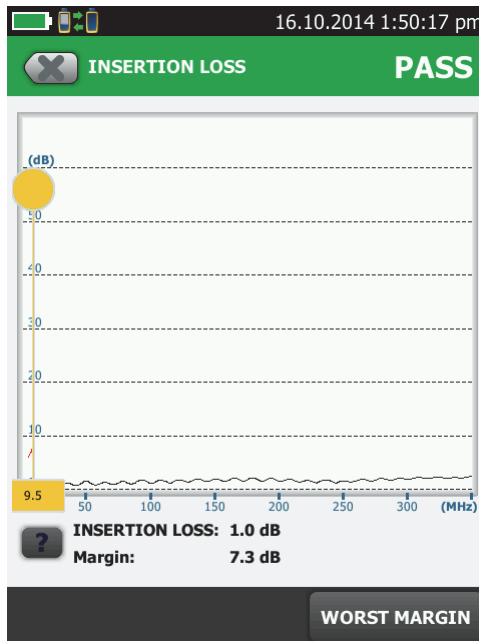

Figure 58. Coaxial Insertion Loss Results

GPU188.PNG

About Splitters

If you get these results, there might be a splitter on the cable:

- The tester cannot find the remote.
- The tester loses communication with the remote. The test might continue, then lose communication again as the splitter interferes with the communication signal.
- The length test shows **End not found**.
- The resistance test shows an open.
- The HDTDR plot shows a reflection that has an unusual shape.

Because splitters can cause unreliable test results, you should not do tests through them.

Tests Without a Remote

You can do the length, resistance, and HDTDR tests without a remote tester. Table 6 describes the effects of a remote on tests.

- 1 Attach a coaxial adapter to the main tester.
- 2 Make sure that the home screen shows the correct settings for the job.

To make sure that other settings are correct, tap the test setup panel, make sure the correct test is selected on the **CHANGE TEST SCREEN**, then tap **EDIT** to see more settings. Table 5 on page 106 describes the settings.

- 3 Connect the tester as shown in Figure 59.
- 4 To do an Autotest: Tap **TEST** on the main tester or press  on the main or remote tester. When the **MEASURE** button shows, tap it to do the length and resistance tests, which do not require a remote tester.

To do only the length or resistance test: On the home screen tap **TOOLS > Single Tests**, then tap a test.

To do only the HDTDR test: On the home screen tap **TOOLS > Diagnostics**, then tap **HDTDR**.

Note

*Because the tester cannot complete all tests, and the reflection at the end of the cable exceeds the 15% limit for the HDTDR test, the result for an Autotest without a remote is always **FAIL**.*

Table 6. Remote Requirements for Coaxial Tests

Test	Remote Requirements*
HDTDR analyzer	Optional. Without a remote, the plot shows large reflections at the end of the cabling.
Resistance	A remote or a terminator is required for a loop resistance measurement.
Length	Not required. Because a coaxial cable terminator eliminates signal reflections, the tester cannot measure the length of terminated cabling. The tester shows End not found in this case.
Impedance	Optional. Without a remote or terminator, the tester cannot measure the impedance of cables longer than 984 ft (300 m). The tester shows Unknown in this case.
Propagation delay	Not required. Because a coaxial cable terminator eliminates signal reflections, the tester cannot measure the propagation delay of terminated cabling. In this case, the tester shows End not found .
Insertion Loss	Required.
* If a remote is not required for a test, the test runs without activating the toner when no remote is detected.	

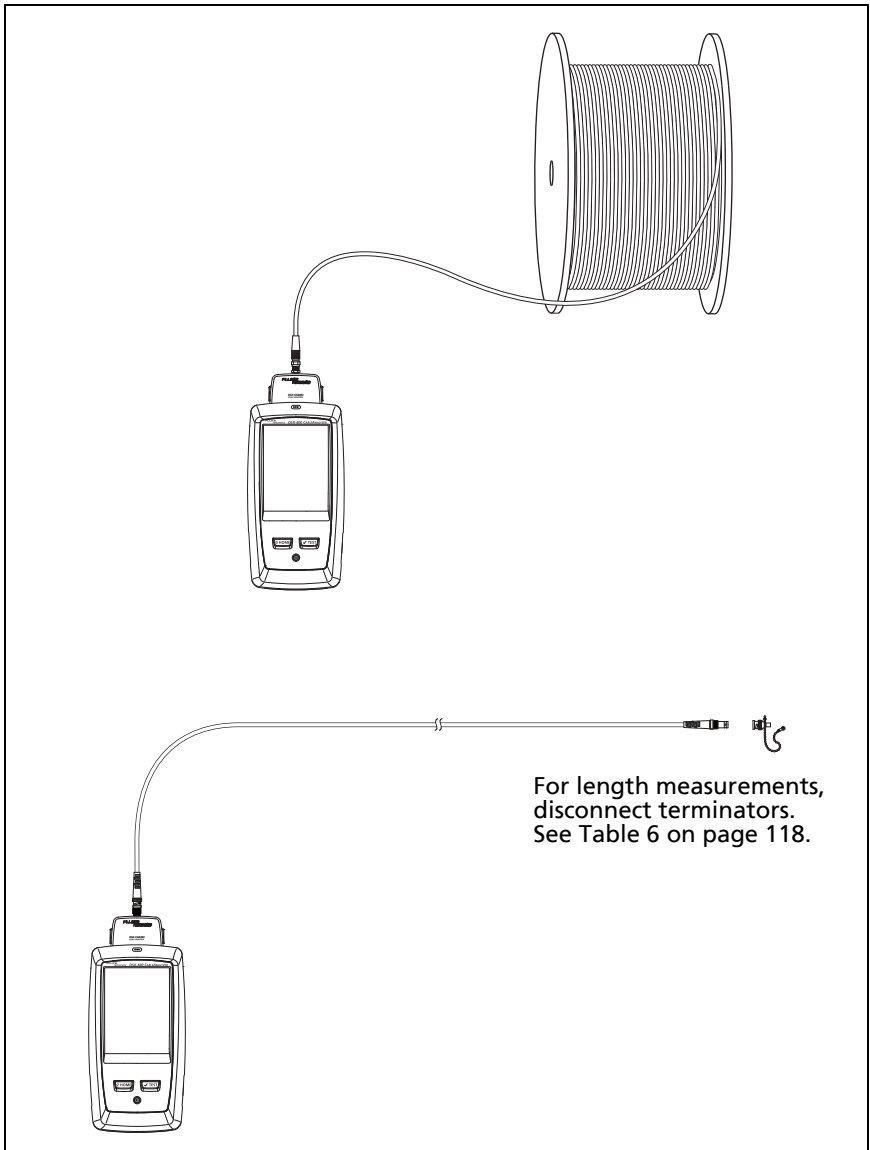

BA183.EPS

Figure 59. Connections for Coaxial Tests Without a Remote

Continuous Tests

To do the length or resistance test continuously, go to the home screen, tap **TOOLS > Single Tests**, then tap a test.

The length and resistance tests do not compare the results to a test limit.

To save the result, tap **SCAN OFF > SAVE**. The saved test has an  for the overall result.

Chapter 6: Diagnose Copper Test Failures

Causes of Twisted Pair Test Failures

Table 7. Causes of Twisted Pair Test Failures

<p>Wire Map test fails</p> <p>Open</p> <ul style="list-style-type: none">• Wires connected to wrong pins at connector or punchdown blocks• Bad connection• Damaged connector or cable• Wrong application for the cable or the wrong outlet configuration is selected <p>Short</p> <ul style="list-style-type: none">• Damaged connector or cable• Conductive material stuck between pins at connector• Incorrect termination at a connector• Wrong application for the cable <p>Split pair, reversed pair, or crossed wires</p> <ul style="list-style-type: none">• Wires connected to wrong pins at connector or punchdown block <p style="text-align: center;"><i>Note</i></p> <p style="text-align: center;"><i>The HDTDX analyzer can help you locate split pairs. See page 127.</i></p> <p>Crossed pairs</p> <ul style="list-style-type: none">• Wires connected to wrong pins at connector or punchdown block• Mix of T568A and T568B wiring standards (1,2 and 3,6 crossed)• Crossover cables used where not needed (1,2 and 3,6 crossed) <p style="text-align: center;"><i>Note</i></p> <p style="text-align: center;"><i>To do the wire map test continuously while you look for a fault, tap SCAN ON on the WIRE MAP FAIL screen, or tap TOOLS > Single Tests > Wire Map.</i></p>

Table 7. Causes of Twisted Pair Test Failures (continued)

A test passes, but the plot shows that measurements exceed the limit

A dB rule possibly applies. See "About dB Rules" on page 90.

Resistance test gives a FAIL, FAIL*, or PASS* result

- Link is too long (may need to remove coiled service loops)
- Bad connection due to oxidized or loose contacts
- Wire gauge is too thin
- Wires in a pair have too much difference in the number of twists (resistance is unbalanced)
- Wrong type of patch cord used

Notes

The HDTDR analyzer can help you locate the cause of a resistance failure. See page 137.

*To do the resistance test continuously while you look for a fault, tap **TOOLS > Single Tests > Resistance**.*

Length gives a FAIL result

- Link is too long (may need to remove coiled service loops)
- NVP is set incorrectly

Note

*To do the length test continuously while you look for a fault, tap **TOOLS > Single Tests > Length**.*

Length exceeds the limit, but the length test did not fail

If the length of the shortest pair does not exceed the limit by 10 %, then the length test passes even if other pairs exceed the limit. This is the 10 % rule for length, as given in the ANSI/TIA standard. See the Fluke Networks Knowledge base for details.

Propagation delay or delay skew gives a FAIL result

- Link is too long (may need to remove coiled service loops)
- Cable has different insulation materials on different pairs. This causes differences in the twist ratios, which causes differences in propagation delays among pairs.

Table 7. Causes of Twisted Pair Test Failures (continued)

<p>“Bad patch cord” message (indicates excessive crosstalk over the first or last 2 m of the cabling)</p> <ul style="list-style-type: none">• Wire pairs are untwisted too much in the RJ45 plug• Poor quality patch cord used for channel• Cable on a permanent link interface adapter is badly distorted or damaged• Wrong test standard selected
<p>Insertion loss gives a FAIL, FAIL*, or PASS* result</p> <ul style="list-style-type: none">• Link is too long (may need to remove coiled service loops)• Poor quality patch cord• Bad connection (possibly shows insertion loss failure on only one or two pairs)• Wrong cable type in the installation• Wrong test standard selected• Wet lubricant in a conduit with unshielded cable. Possibly, the test will pass after the lubricant dries.
<p>Characteristic impedance exceeds the limit or an anomaly is detected</p> <ul style="list-style-type: none">• Bad connection• Cable compression (tight cable ties, pinches, kinks, etc.)• Mismatch of cable types• Water in the cable jacket
<p>Return loss gives a FAIL, FAIL*, or PASS* result</p> <ul style="list-style-type: none">• Patch cord or cable impedance not 100 Ω• Patch cord handling causing changes in impedance• Excessive amount of cable jammed into outlet box• Tight service loops in telecommunications closet• Excessive untwisting of pairs at connector• Poor quality connectors• Cable impedance not uniform (poor quality cable)

-continued-

Table 7. Causes of Twisted Pair Test Failures (continued)

Return loss gives a FAIL, FAIL*, or PASS* result (continued)

- Mismatches in cable construction (such as cable from different manufacturers)
- Water in the cable jacket (typically causes failures on all pairs at lower frequencies)
- Cable compression (tight cable ties, pinches, kinks, etc.)
- Poorly matched plug and jack (6A/Class E_A applications)
- Wrong test standard selected
- Defective link interface adapter

Note

The HDTDR analyzer can help you locate the cause of a return loss failure. See page 137.

NEXT, PS NEXT, ACR-N, PS ACR-N, ACR-F, PS ACR-F gives a FAIL, FAIL*, or PASS* result

- Excessive untwisting of pairs at a connector
- Poor quality patch cords
- Poor quality connectors
- Poor quality cable
- Poorly matched plug and jack (6A/Class E_A applications)
- Incorrect link interface adapter
- Cable compression that distorts the pattern of twists in the pairs (tight cable ties, pinches, kinks, etc.)
- Inappropriate use of couplers
- Excessive noise source near cabling under test
- Wrong test standard selected

Note

The HDTDX analyzer can help you locate the cause of a NEXT failure. See page 127.

Correcting NEXT problems usually corrects ACR-F problems.

Causes of Coaxial Test Failures

Table 8. Causes of Coaxial Test Failures

<p>Resistance test gives a FAIL, FAIL*, or PASS* result</p> <ul style="list-style-type: none">• Link is too long (may need to remove coiled service loops)• Bad connection due to oxidized or loose contacts• Wrong type of patch cord used• For tests on terminated cable, the terminator's resistance is incorrect <p><i>Notes</i></p> <p><i>The HDTDR analyzer can help you locate the cause of a resistance failure. See "The HDTDR Analyzer" on page 127.</i></p> <p><i>To do the resistance test continuously while you look for a fault, tap TOOLS > Single Tests > Resistance.</i></p>
<p>Length gives a FAIL result</p> <ul style="list-style-type: none">• Link is too long (may need to remove coiled service loops)• NVP is set incorrectly <p><i>Note</i></p> <p><i>To do the length test continuously while you look for a fault, tap TOOLS > Single Tests > Length.</i></p>
<p>Length gives an End Not Found result</p> <ul style="list-style-type: none">• A terminator is connected to the far end of the cable• The cable is connected to a splitter
<p>Propagation delay gives a FAIL result</p> <p>Link is too long (may need to remove coiled service loops)</p>
<p>Insertion loss gives a FAIL, FAIL*, or PASS* result</p> <ul style="list-style-type: none">• Link is too long (may need to remove coiled service loops)• Poor quality patch cord• Bad connection• Wrong cable type in the installation• Wrong test standard selected

Table 8. Causes of Coaxial Test Failures (continued)

<p>Characteristic impedance exceeds the limit</p> <ul style="list-style-type: none">• Bad connection• Cable compression (tight cable ties, pinches, kinks, etc.)• Mismatch of cable types• Water in the cable jacket• Incorrect terminator resistance
<p>HDTDR test fails (a reflection exceeds the 15% limit)</p> <ul style="list-style-type: none">• Bad connection due to oxidized or loose contacts• Mismatch of cable types

The HDTDR Analyzer

While return loss test results shows return loss relative to frequency, the HDTDR™ (High-Definition Time Domain Reflectometry) analyzer shows return loss relative to its distance from the tester. The HDTDR plot shows the locations and amplitudes of return loss signals to help you find the causes of return loss failures.

After an Autotest on twisted pair cable, you can see HDTDR plot if the Autotest had a **FAIL**, **FAIL*** or **PASS*** result, or if **HDTDX/HDTDR** on the **TEST SETUP** screen was set to **All Autotests** when you did the test.

For tests on coaxial cable, the HDTDR plot is always available after an Autotest.

To see the HDTDR plot for an Autotest, tap the **DIAGNOSTIC** tab on the Autotest results screen, then tap **HDTDR ANALYZER**. Figure 60 shows an example of an HDTDR plot for twisted pair cable. Figure 62 shows an HDTDR plot for coaxial cable.

Note

*If **Store Plot Data** is off, the tester does not include the HDTDR plot with results you save.*

To get HDTDR analyzer results you can also tap **Tools > Diagnostics**.

Figure 61 shows how some common faults appear on HDTDR plots.

- ① The vertical scale shows the percentage of the signal reflected back to the main tester. The amplitudes of signals on the plot show how much the impedance of the cabling changes.
- ② The measurement cursor. The box at the bottom of the cursor shows the distance from the start of the cabling to the cursor.

To measure distance, tap the yellow circle so that **MARK** shows, drag the cursor to the start of the measurement, tap **MARK**, then drag the cursor to the end of the measurement. See “How to Use the Measurement Cursor on the HDTDR and HDTDX Plot” on page 137.

- ③ The horizontal scale shows the distance along the cabling.

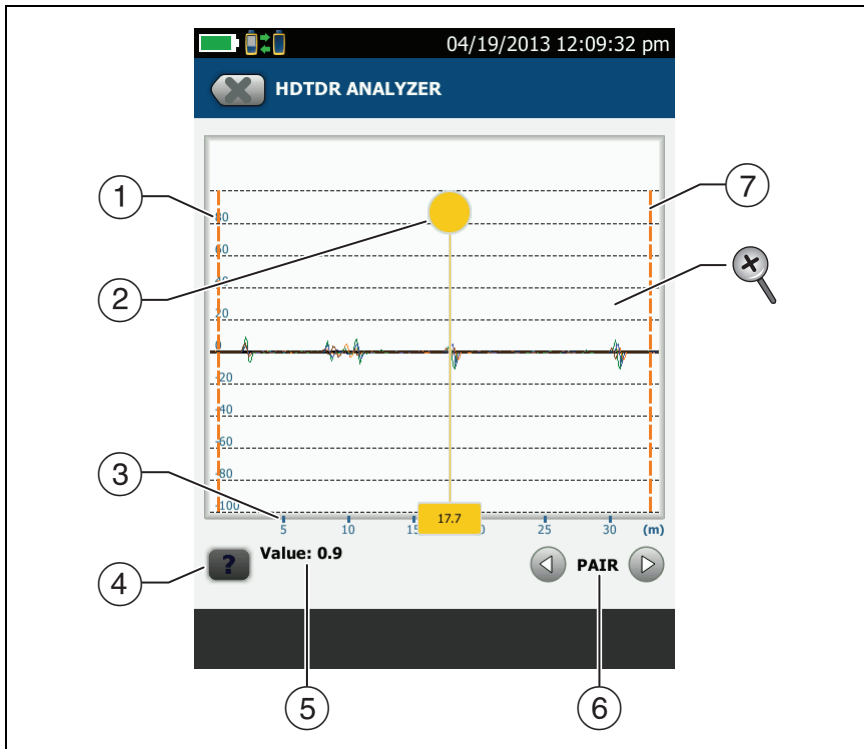

GPU115.EPS

Figure 60. HDTDR Plot for Twisted Pair Cable

④ Tap **?** to see help for this screen.

⑤ The **Value** is the percentage of the signal reflected at the cursor's location. If the plot shows all cable pairs, the value shown is the largest of all the pairs.

The tester adjusts the values for insertion loss so they show the amplitudes of the signals at the sources of the reflections.

⑥ To see the plots for individual pairs, tap **◀** or **▶**. To select pairs to show on the plot, touch **◀** or **▶** for one second to see the **SELECT PAIRS** window. Select the pairs you want to see, then tap **OK**.

- ⑦ The orange, dashed lines are at the start and end of the cabling that the tester includes in the test results.
- 🔍 To zoom in and out, use the pinch, reverse-pinch, and double-tap gestures on the touchscreen. You can also use the zoom controls to change the magnification on the distance and amplitude scales independently. See Figure 8 on page 21.

Note

For HDTDR plots for short cables such as patch cords, the tester does not change the magnification for the distance (horizontal) scale.

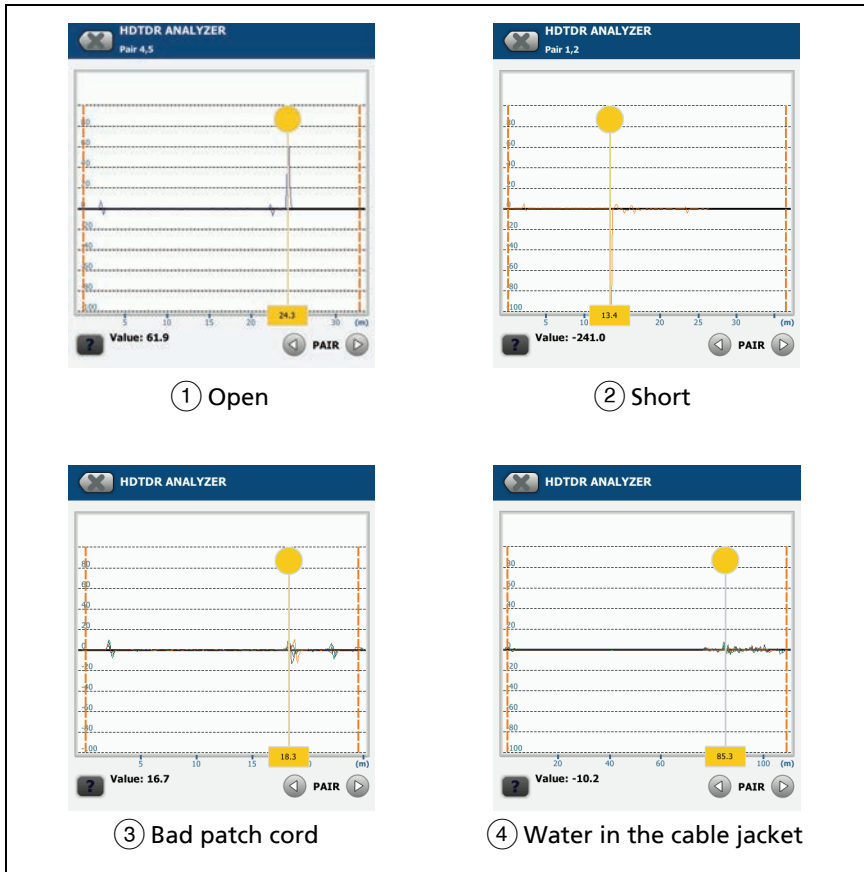

GPU100.EPS

Figure 61. Common Faults Shown on HDTDR Plots

- ① Open on pair 4,5 at approximately 24.3 m. A positive reflection is an increase in impedance.
- ② Short on pair 1,2 at approximately 13.4 m. A negative reflection is a decrease in impedance.
- ③ Bad patch cord approximately 18.3 m from the main tester. This patch cord was badly damaged.
- ④ A link with a section of cable that has water in the jacket.

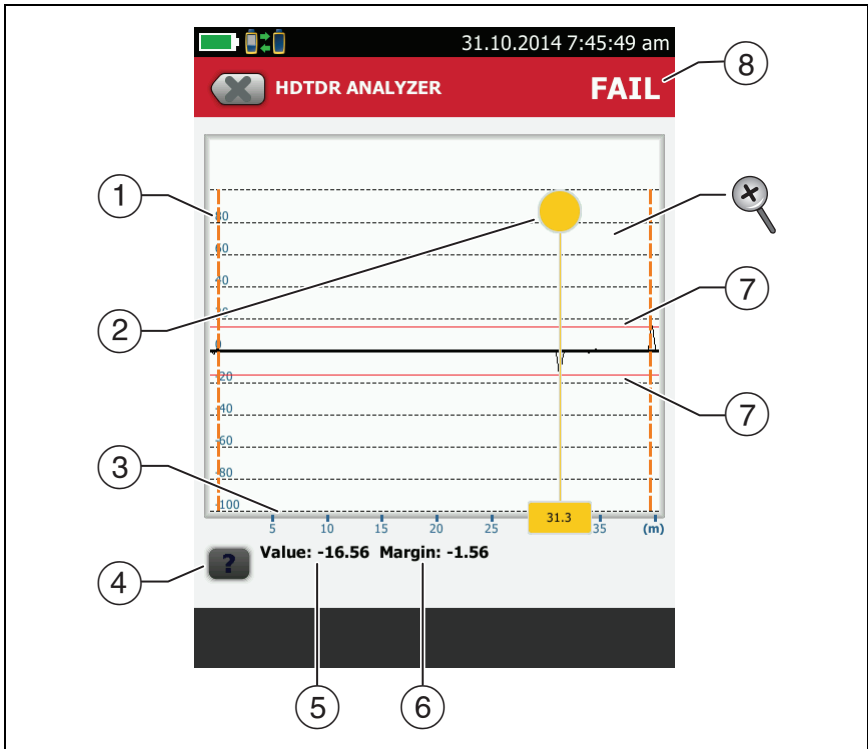

GPU189.EPS

Figure 62. HDTDR Plot for Coaxial Cable

- ① The vertical scale shows the percentage of the signal reflected back to the main tester. The amplitudes of signals on the plot show how much the impedance of the cabling changes.
- ② The measurement cursor. The box at the bottom of the cursor shows the distance from the start of the cabling to the cursor.

To measure distance, tap the yellow circle so that **MARK** shows, drag the cursor to the start of the measurement, tap **MARK**, then drag the cursor to the end of the measurement. See "How to Use the Measurement Cursor on the HDTDR and HDTDX Plot" on page 137.

- ③ The horizontal scale shows the distance along the cabling.

- ④ Tap  to see help for this screen.
- ⑤ The **Value** is the percentage of the signal reflected at the cursor's location.

The tester adjusts the values for insertion loss so that they show the amplitudes of the signals at the sources of the reflections.
- ⑥ The margin is the difference between the measured value and the 15% reflection limit. The margin is negative if the value exceeds the limit.
- ⑦ The HDTDR plot for coaxial cable includes limit lines and a **PASS/FAIL** result. The lines are fixed at 15%. The tester uses these limits to give the test a **PASS/FAIL** result. Figure 62 shows a reflection at 31.3 m that exceeds the limit. The reflection was caused by a 50 Ω cable connected a 75 Ω cable.
-  To zoom in and out, use the pinch, reverse-pinch, and double-tap gestures on the touchscreen. You can also use the zoom controls to change the magnification on the distance and amplitude scales independently. See Figure 8 on page 21.

Note

For HDTDR plots for short cables such as patch cords, the tester does not change the magnification for the distance (horizontal) scale.

The HDTDIX Analyzer

While NEXT test results shows crosstalk signals relative to frequency, the HDTDIX™ (High-Definition Time Domain Crosstalk) analyzer shows crosstalk signals relative to their distance from the tester. The HDTDIX plot shows the locations and amplitudes of crosstalk signals to help you find the causes of NEXT and ACR-F failures.

After an Autotest, you can see HDTDIX plot if the Autotest had a **FAIL**, **FAIL*** or **PASS*** result, or if **HDTDIX/HDTDR** on the **TEST SETUP** screen was set to **All Autotests** when you did the test.

To see the HDTDIX plot for an Autotest, tap the **DIAGNOSTIC** tab on the Autotest results screen, then tap **HDTDIX ANALYZER**. Figure 64 shows an example of an HDTDIX plot.

Note

*If **Store Plot Data** is off, the tester does not include the HDTDIX plot with results you save.*

To get HDTDIX analyzer results you can also tap **Tools > Diagnostics**, but you cannot save these results.

Figure 64 shows how some common faults appear on HDTDIX plots.



To zoom in and out, use the pinch, reverse-pinch, and double-tap gestures on the touchscreen. You can also use the zoom controls to change the magnification on the distance and amplitude scales independently. See Figure 8 on page 21.

Note

For HDTDIX plots for short cables such as patch cords, the tester does not change the magnification for the distance (horizontal) scale.

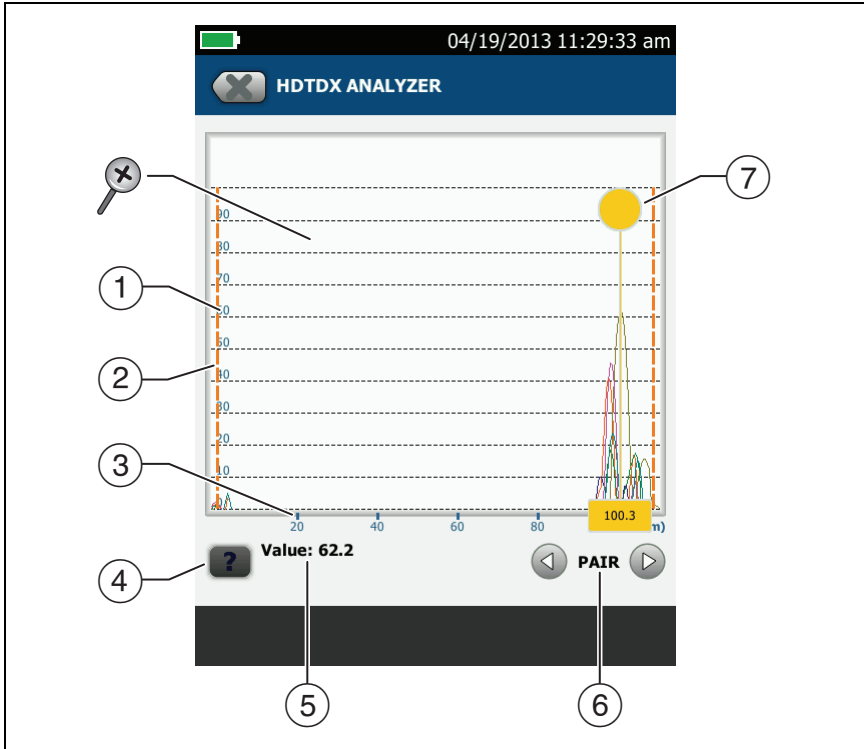





GPU114.EPS

Figure 63. HDTDX Plot

- ① The vertical scale shows the amplitudes of the crosstalk signals. The numbers on the scale are for reference only and do not have units. The values on the scale are related to the limits for NEXT in the selected test limit. For example, a crosstalk signal that goes to 20 on the scale when you use a Cat 5 limit goes to over 40 when you use a Cat 6 limit.
- ② The orange, dashed lines are at the start and end of the cabling that the tester includes in the test results.
- ③ The horizontal scale shows the distance along the cabling.

- ④ Tap  to see help for this screen.
- ⑤ The **Value** is the value of the crosstalk at the cursor's position. If the plot shows all cable pairs, the value shown is the largest of all the pairs.

The tester adjusts the values of crosstalk for insertion loss so that the plot shows the values as they are at the sources of the crosstalk.

- ⑥ To see the plots for individual pairs, tap  or . To select pairs to show on the plot, touch  or  for one second to see the **SELECT PAIRS** window. Select the pairs you want to see, then tap **OK**.
- ⑦ The measurement cursor. The box at the bottom of the cursor shows the distance from the start of the cabling to the cursor.

To measure distance, tap the yellow circle so that **MARK** shows, drag the cursor to the start of the measurement, tap **MARK**, then drag the cursor to the end of the measurement. See "How to Use the Measurement Cursor on the HDTDR and HDTDx Plot" on page 137.

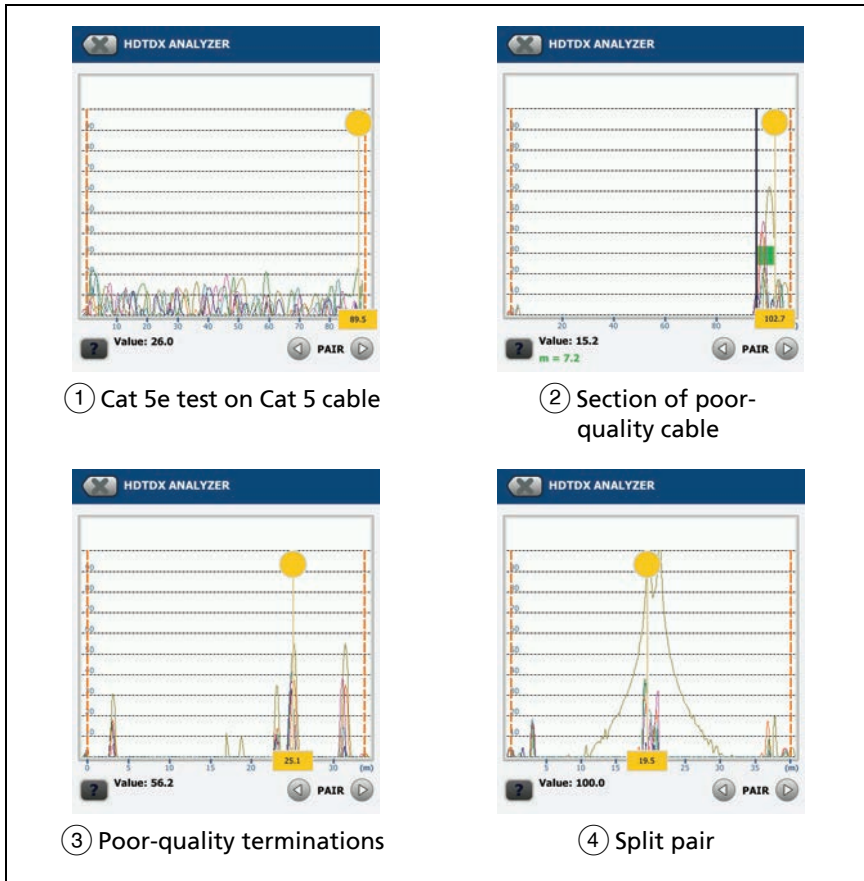

GPU99.EPS

Figure 64. Typical Faults Shown on HDTDX Plots



- ① Cat 5e test on a Cat 5 cable.
- ② Approximately 7 m of bad cable near the remote.
- ③ Poor-quality terminations. A typical cause is excessive untwisting of the wire pairs.
- ④ Split pair on 3,6-4,5. The split pair is in a patch cord approximately 19.5 m from the main tester.

How to Use the Measurement Cursor on the HDTDR and HDTDY Plot

You can use the cursor on the HDTDR and HDTDY plots to measure the distance to a source of high return loss or crosstalk from any point on the plot. You can also measure the length of a segment or patch cord that causes high return loss or crosstalk.

To use the measurement cursor to measure distance

Refer to Figure 65.

- 1 Tap the yellow circle at the top of the cursor (②) so that **MARK** shows.
- 2 While **MARK** shows, use one of these methods to move the cursor to the point where you want to start the measurement:
 - Drag the cursor with the yellow circle (②).
 - Tap or press and hold  or  (③).
- 3 Tap **MARK**, then while **UNMARK** shows, move the cursor to the point where you want to end the measurement.

Note

*If **UNMARK** and the cursor controls do not show, tap the yellow circle.*

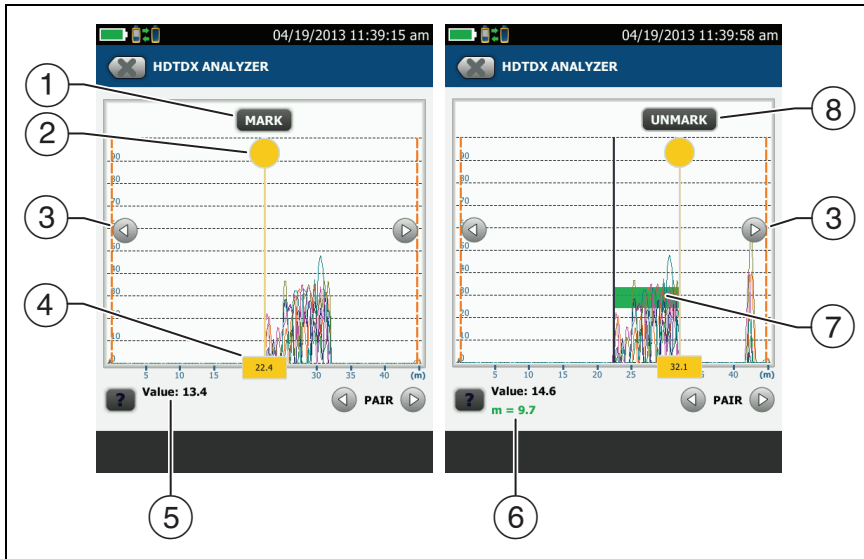

The distance between the cursor and the mark shows below the plot (⑦).

- 4 To make a new measurement, tap the yellow circle, tap **UNMARK** (⑩), then do steps 1, 2, and 3 again.



GPU113.EPS

Figure 65. How to Use the Measurement Cursor on the HDTDR or HDTDX Plot

- ① To specify the start of a measurement, tap the yellow circle (②), then tap **MARK**.
- ② To see the **MARK** and **UNMARK** buttons, tap the yellow circle. When **MARK** or **UNMARK** shows, you can drag the cursor.
- ③ To move the cursor in small increments, tap or press and hold  or . If these buttons do not show, tap the yellow circle on the cursor.
- ④ The measurement in the box is the distance from the start of the cabling to the cursor.
- ⑤ The measured value of crosstalk or return loss at the cursor's location.
- ⑥ The distance between the start and end of the green measurement bar.

- ⑦ The green measurement bar goes from the start point to the end point of your measurement.
- ⑧ To start another measurement, tap **UNMARK**. If **UNMARK** does not show, tap the yellow circle (②).

Chapter 7: Manage Test Results

View Saved Results

You can view the results in a project, or see a summary of the results in all projects.

On the home screen, tap the **RESULTS** icon. The **RESULTS** screen shows the results in the active project. See Figure 66.

To view results saved on a USB flash drive, connect the drive, then tap **RESULTS, TRANSFER, USB Flash Drive, Import**. See “Manage Results on a Flash Drive” on page 146.

To organize results and make reports you can give to customers, use LinkWare™ PC software.



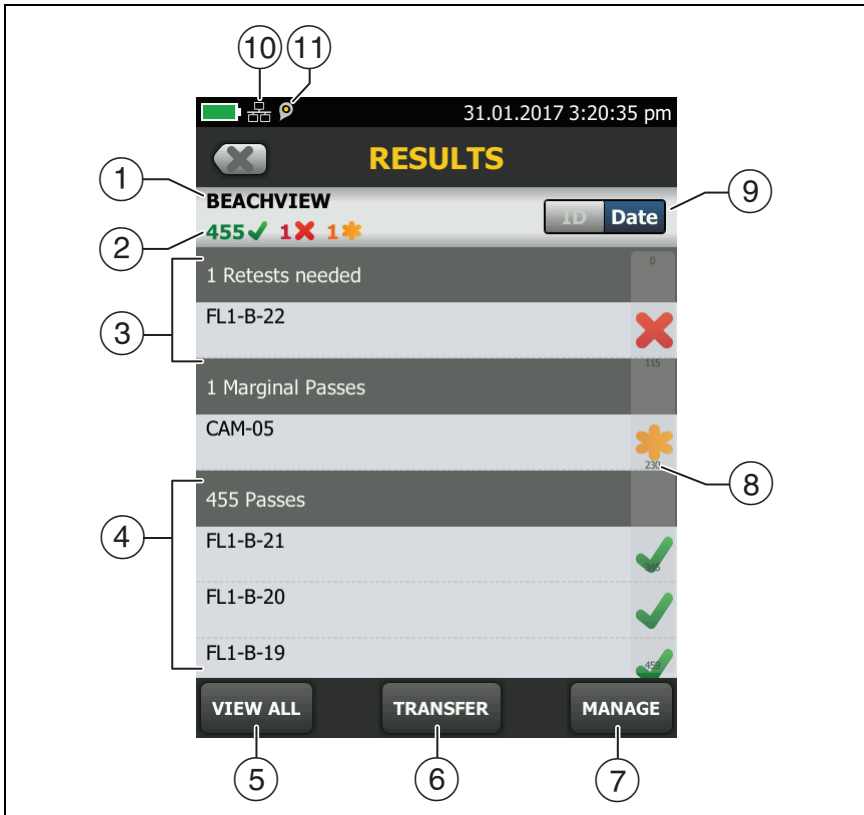

To manage results in the cloud from a desktop or mobile device, use the LinkWare Live web application. See Chapter 9.



BA24.EPS

Figure 66. RESULTS Screen

- ① The name of the active project.
- ② : The number of results that passed. This includes individual results for each ID and tests that have an result.
- : The number of results that failed. This includes individual results for each ID.
- : The number of DSX CableAnalyzer results that have **PASS*** results. **PASS*** results have measurements within the range of accuracy uncertainty for the tester. See “PASS*/FAIL* Results” on page 94.

- ③ The cable IDs that have **FAIL** results and must be tested again. Because some IDs can have one or more tests that failed, the number at the top of this screen (②) can be more than the number of retests needed.
- ④ The cable IDs that have an overall **PASS** or  result.
- ⑤ Tap **VIEW ALL** to see a summary of the results in all the projects in the tester.
- ⑥ **TRANSFER** lets you export or import results to or from a flash drive, and delete results on the flash drive.
- ⑦ Tap **MANAGE** to delete or rename results that are in the tester.
- ⑧ The scroll bar shows when the list of results is long. To use the scroll bar, tap on the bar or slide your fingertip on the bar. For example, to see the 12th result in the list, tap on “12” in the scroll bar. When you slide your fingertip on the bar, the number of the result you can see is next to your fingertip.
- ⑨ Tap the **ID/Date** control to sort the results by cable ID or by date. When you sort by ID, the results show in ascending order. When you sort by date, the latest result is at the top of the list.
- ⑩ These icons show when you connect the tester to a network to use Fluke Networks cloud services:
 -  The tester is connected to a wireless network.
 -  The tester is connected to a wired network.See Chapter 9.
- ⑪  The asset management icon shows when the owner of a LinkWare Live account has enabled the asset management service for the tester. See “About the Asset Management Service” on page 179.

How to Replace a Saved Result that Failed

To use the same test settings that were used for the saved result

- 1 On the home screen, tap the **RESULTS** icon.
- 2 On the **RESULTS** screen, tap a result that failed.
- 3 Tap **TEST AGAIN**.
- 4 When the test is completed, and if **Auto Save** is on, the tester asks you if you want to overwrite the results. Tap **Yes**.

If **Auto Save** is off, tap **FIX LATER** (if the test failed) or **SAVE** (if the test passed) to save the result.

To replace a result with a result that uses different test settings

- 1 Turn off **Auto Save**.
- 2 Make sure that the home screen shows the project that contains the result you want to replace.
- 3 Select the necessary test settings.
- 4 Do the test, tap **FIX LATER** (if the test failed) or **SAVE** (if the test passed), then enter the ID of the saved result.
- 5 The tester asks you if you want to overwrite the results. Tap **Yes**.

Delete, Rename, and Move Results

Before you delete, rename, or move results, select the project that contains the results and go to the **MANAGE RESULTS** screen:

- 1 On the home screen, tap the **RESULTS** icon. The **RESULTS** screen shows the results in the active project.
- 2 To see the results in another project, tap **VIEW ALL**, then tap a project.
- 3 Tap **MANAGE** to see the **MANAGE RESULTS** screen.

To delete results

- 1 On the **MANAGE RESULTS** screen, select the results you want to delete.

To select all the tests that failed or all the tests that passed, tap **Select All Retests** or **Select All Passes**.

- 2 Tap **DELETE**, then tap **DELETE** in the confirmation dialog.

To rename results

- 1 On the **MANAGE RESULTS** screen, select one result to rename.
- 2 Tap **RENAME**.
- 3 Enter a new name, then tap **DONE**.

To move results to a different project

- 1 On the **MANAGE RESULTS** screen, select the results you want to move.
- 2 Tap **MOVE**.
 - To move the results to a project shown in the list, tap the project name, then tap **MOVE** in the confirmation dialog.
 - To make a new project and move the results to the new project, tap **NEW PROJECT**, enter a project name, tap **DONE**, then tap **MOVE** in the confirmation dialog.

Note

When you move results to a different project, that project becomes the active project.

Manage Results on a Flash Drive

You can export or import results to or from a flash drive, and delete results on the flash drive.

To export or import project settings along with results, see “Manage Projects on a Flash Drive” on page 171.

Caution

- **Do not remove the USB flash drive while the LED on the drive flashes. Doing so can corrupt the data on the drive.**
- **You can lose a USB flash drive, cause damage to it, or accidentally erase the contents of the drive. Thus, Fluke Networks recommends that you save no more than one day of test results on a flash drive or that you upload results to LinkWare Live.**

Note

The tester reads only USB drives that use the FAT format.

- 1 Connect a USB flash drive to the type A USB port. The tester makes a bell sound when it detects the drive.
- 2 On the home screen, tap the **RESULTS** icon, then tap **TRANSFER**.
- 3 On the **TRANSFER RESULTS** screen, tap **USB Flash Drive**, then tap a function.
 - **Export:** On the **EXPORT RESULTS** screen, select **New** or **All**, select the project that contains the results you want to export to the flash drive, then tap **EXPORT**.
New: Export only results that do not have the same IDs as results that are already on the flash drive.
All: Export all results from the projects you select.

Note

Cable IDs are case-sensitive. For example, the tester saves result with the names "A0" and "a0" in two different records.

- **Import:** On the **IMPORT RESULTS** screen select the project that contains the results you want to import from the flash drive, then tap **IMPORT**.
- **Delete:** On the **DELETE RESULTS** screen select the project that contains the results you want to delete on the flash drive, then tap **DELETE**.

Upload Results to a PC

Note

To upload results to the cloud for transfer to a PC, use the LinkWare Live web application. See Chapter 9.

To upload results to a PC from the tester or a flash drive, use LinkWare PC software.

- 1 Install the latest version of LinkWare PC software on the PC.
- 2 Turn on the tester and start LinkWare PC on the PC.
- 3 Use the USB cable supplied to connect the Micro-AB USB port on the tester to a type A USB port on the PC. See Figure 67.
- 4 Or connect a USB flash drive to the PC.
- 5 On the LinkWare PC toolbar, click , then select a product, or select **Test Files (.tst)** to upload from a flash drive.
- 6 In the **Import** dialog box in LinkWare PC, select options for the location and the number of results to import.

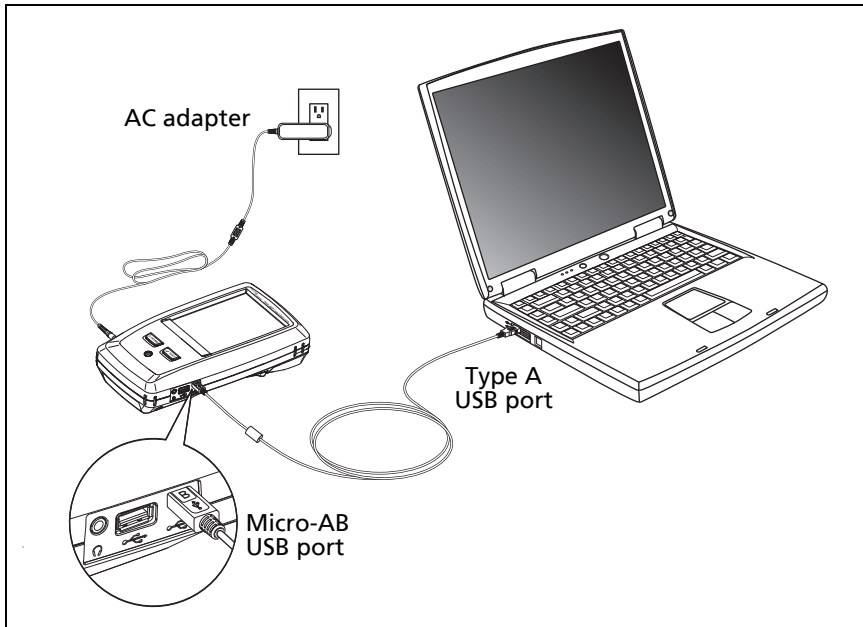

BA46.EPS

Figure 67. How to Connect the Tester to a PC

About LinkWare Live

The LinkWare Live web application lets you manage your results and projects from a desktop or mobile device, locate your DSX-600 testers in the field, and more. To get started with LinkWare live, see Chapter 9 or go to go to www.linkwarelive.com/signin.

View the Memory Status

To see the memory status

On the home screen, tap the **TOOLS** icon, then tap **Memory Status**.

The **MEMORY STATUS** screen shows these values:

- The percentage of memory available
- The number of test records that are saved
- The number of .id files that have been downloaded to the tester from LinkWare PC software
- The memory space taken by other files, such as the databases for projects and test limits

For information on memory capacity, see “Internal Memory for Test Results” on page 213.

Chapter 8: Use Projects

Why Use Projects?

The tester's ProjX™ management system lets you set up projects that help you monitor the status of a job and make sure that your work agrees with the requirements of the job.

You can use a project to do these tasks:

- Specify the tests that are necessary for a job.
- Specify settings for tests.
- Specify an operator for the job.
- Make sets of sequential IDs to use as names for test results.
- Automatically save test results with IDs from a set.
- See which IDs do not have results for a specified test.
- See what percentage of a job is completed.
- See how many links passed and how many failed.
- Keep the test results from a job in one place for easy access.

When you use a project, you can do tests and use IDs that are not specified in the project if necessary. You can also easily change the settings in a project if necessary.

Note

To manage projects in the cloud, use the LinkWare Live web application. See Chapter 9.

Tutorial: Make a New Project

To start a new project, tap the **PROJECT** panel on the home screen. Figure 68 shows the **PROJECT** screen and describes the items you enter to make a project.



The tester can have up to 100 projects.



GPU08.EPS

Figure 68. PROJECT Screen

- 1 The name of the project. See also item 9.
- 2 **Operator:** The name of the person who will do the tests for the project. For each operator you can also enter the email address that the operator will use as an ID to sign in to LinkWare Live.

- ③ The date range for the results in the project.
- ④ **Results:** A summary of the test results in the project:
 - : The number of tests that failed.
 - : The number of tests that passed.
 - : The number of results from tests on twisted pair cable that have **PASS*** results. **PASS*** results have measurements within the range of accuracy uncertainty for the tester. See “**PASS*/FAIL* Results**” on page 94.



To see the results, tap the panel.
- ⑤ **Test Setup:** The tests that are necessary for each cable in the project.

To add a test to the project, tap **NEW TEST**.

For information about twisted pair test settings, see Chapter 3.
- ⑥ **Cable ID Sets:** The sets of IDs the tester can use for the names of test results.

To add a set of IDs to the project, tap **NEW ID SET**. See “How to Make ID Sets” on page 165.
- ⑦ To use a different project, tap **CHANGE PROJECT**, then tap a project.

To make a new project, tap **CHANGE PROJECT**, then tap **NEW PROJECT**.
- ⑧ **TRANSFER** lets you export or import projects to or from a flash drive, and delete projects on the flash drive. The project data includes all project settings and test results.
- ⑨ **MANAGE** lets you rename, copy, or delete a project that is in the tester:
 - **Rename:** Lets you give the project a new name. The tester saves all the settings and test results in the project with the new name.

- **Copy:** Lets you use the settings in the project to start a new project. The tester does not put test results into the new project.
 - **Delete:** Lets you delete the project and all the test results in the project. The tester shows a warning if you have uploaded less than 100% of the results to a PC.
- ⑩ To delete the test setup or ID set, tap . To copy the test setup or ID set so you can edit it to make a new one, tap .

Notes

If you delete an imported ID set from a project, the ID set is still available in the tester. To delete imported ID sets from the tester, use LinkWare PC software. See “Delete an Imported ID Set” on page 169.

*A project must have at least one **Test Setup** and one **Cable ID** set. If you delete them all, the tester makes a default **Test Setup** and **Cable ID** set.*

Step 1: Give the Project a Name

- 1-1 On the home screen, tap the **PROJECT** panel. The **PROJECT** screen shows the active project.
- 1-2. Tap **CHANGE PROJECT**, then tap **NEW PROJECT**.
- 1-3. Use the keyboard to enter a name for the project, then tap **DONE**.

Step 2: Specify an Operator

The operator is the person who will use the project to do a job.

- 2-1 On the **PROJECT** screen, tap the **Operator** panel, then select or add an operator:
 - To select a different operator, then tap a name in the **OPERATOR** list.
 - To add an operator to the list, tap **NEW OPERATOR**, use the keyboard to enter a name.

- 2-2. Optional: Enter the email address that the operator will use as an ID to sign in to LinkWare Live.
- 2-3. When you are finished, tap **DONE**.
- 2-4. To go back to the **PROJECT** screen, tap the name of the operator you want to use.

Step 3: Set up Tests for the Project

A project includes the tests and settings for the tests that are necessary for a job. If you do not specify settings for a test, the tester uses the default settings.

For this tutorial, your project will include tests for twisted pair cable.

To set up a twisted pair test for the project

- 3-1 On the **PROJECT** screen, tap **NEW TEST**.
- 3-2. On the **TEST SETUP** screen, select and change the test settings as necessary for a test on twisted pair cable. For information about twisted pair test settings, see “Settings for Twisted Pair Tests” on page 82.
- 3-3. When you have completed your selections for the twisted pair cable test, tap **SAVE** on the **TEST SETUP** screen.

(continued)

Step 4: Make ID Sets

To see the **CABLE ID SETUP** screen

- On the home screen, tap the **PROJECT** panel, then tap **NEW ID SET** on the **PROJECT** screen.
- Or, on the home screen, tap the **Next ID** panel, tap **CHANGE CABLE IDs**, then tap **NEW ID SET** on the **CHANGE CABLE IDs** screen (see Figure 69 on page 157).

To make a cable ID set

- 4-1 On the home screen, tap the **PROJECT** panel, then tap **NEW ID SET** on the **PROJECT** screen.
- 4-2. For this tutorial, you will make an ID set that has 12 IDs for twisted pair cabling:
 - a. On the **CABLE ID SETUP** screen (Figure 70 on page 158), tap the box under **First ID**, use the keyboard to enter B-00.
 - b. Tap the box under **Last ID**, use the keyboard to enter D-03, then tap **DONE**.
 - c. Tap **REVIEW**. The **CABLE ID REVIEW** screen shows the ID set and the total number of IDs.
- 4-3. To save the ID set, tap **SAVE** on the **CABLE ID REVIEW** screen.

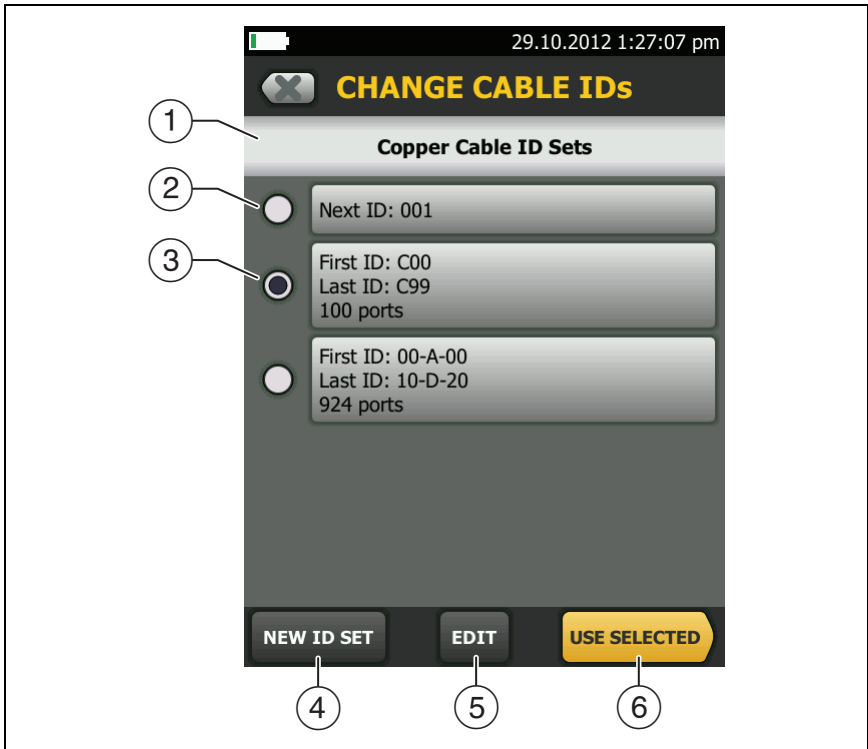

GPU90.EPS

Figure 69. CHANGE CABLE IDs Screen

- ① The screen shows the ID sets for the type of test setup that shows on the home screen.
- ② The ID set "001" is the default set the tester makes if no other ID sets are in the project
- ③ To select an ID set, tap the ID set.
- ④ To add an ID set to the project, tap **NEW ID SET**.
- ⑤ To edit an ID set, tap the set, then tap **EDIT**.
- ⑥ To use the selected ID set, tap **USE SELECTED**.

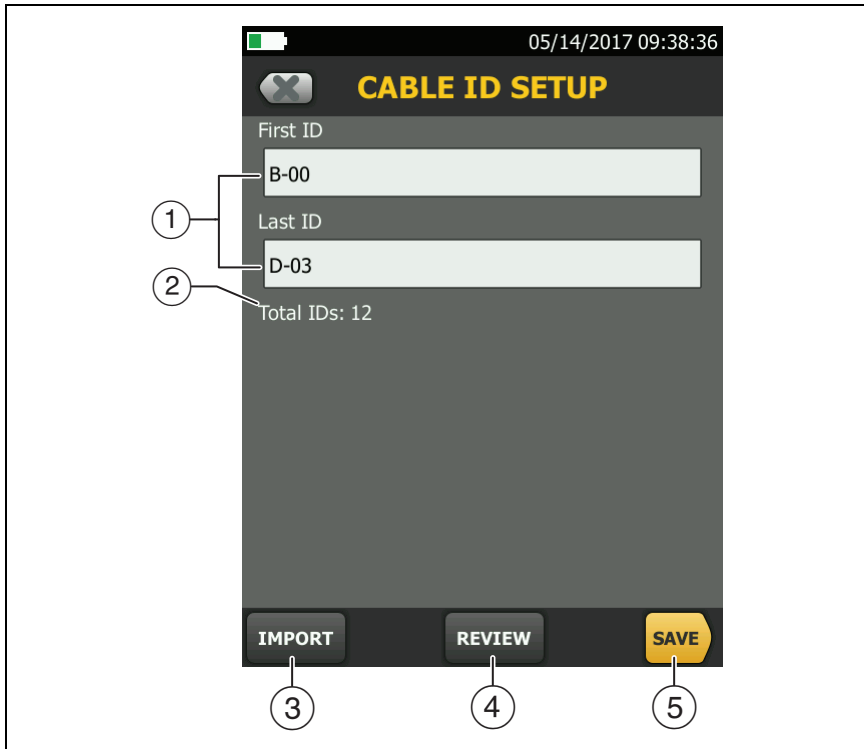

BA56.EPS

**Figure 70. CABLE ID SETUP Screen
(after you enter the first and last IDs)**

- ① **First ID and Last ID:** The first and last IDs in a set of sequential IDs. See "How to Make ID Sets" on page 165.

If you do not enter a **Last ID** when you make an ID set, the tester will increment the **First ID** to make subsequent IDs. When you use an ID set that does not have a **Last ID**, the set under **IDs Untested** on the **CHANGE ID** screen shows only the next ID.

Note

The tester does not increment symbols or accented characters.

- ② **Total IDs:** The number of IDs in the set. This section does not show for ID sets that do not have a **Last ID**.
- ③ Tap **IMPORT** to use an ID set that you downloaded to the tester from LinkWare PC software.
- ④ Tap **REVIEW** to see the **CABLE ID REVIEW** screen, which shows the ID set and the total number of IDs. See “How to Make ID Sets” on page 165.

Note

*The **REVIEW** button is not available if you do not enter a **Last ID**.*

- ⑤ **SAVE:** To save the ID set, tap **SAVE**.

Step 5: Turn on the Auto Save Function

When **Auto Save** is on, the tester automatically saves results with the next available ID. If a test fails, you can do the test again for the same ID if necessary, or do a test for the next ID.

5-1 On the **CHANGE ID** screen, make sure that the **Auto Save** control shows **On**.

5-2. Tap **DONE**.

Tutorial: How to Use a Project for Tests

This tutorial assumes that you completed the tutorial “Make a New Project” on page 152.

Figure 71 shows the minimum equipment necessary for this tutorial.

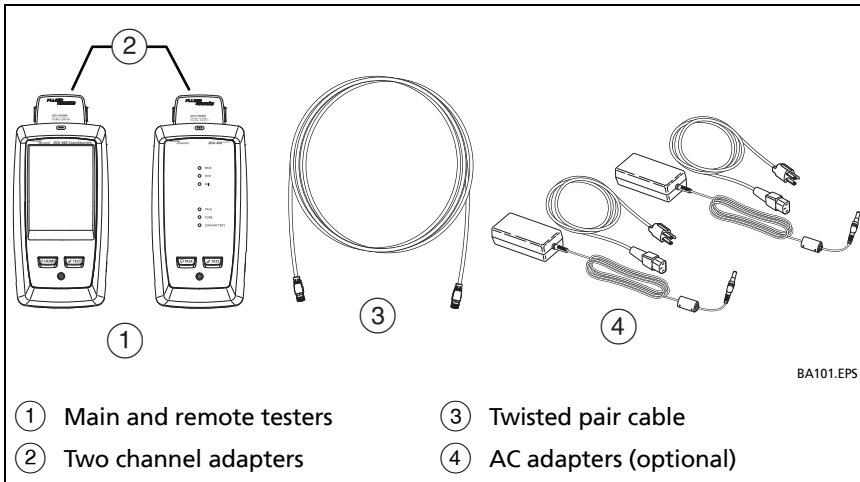

Figure 71. Equipment for the Twisted Pair Project Tutorial

Step 1: Select a Project

If the correct project name does not show on the home screen, tap the **PROJECT** panel, tap **CHANGE PROJECT**, tap the name of a project, then tap **DONE**.

Step 2: Select a Test for Twisted Pair Cable

On the home screen, tap the test type panel, on the **CHANGE TEST** screen (Figure 72), tap the test you made for twisted pair cable, then tap **USE SELECTED**.

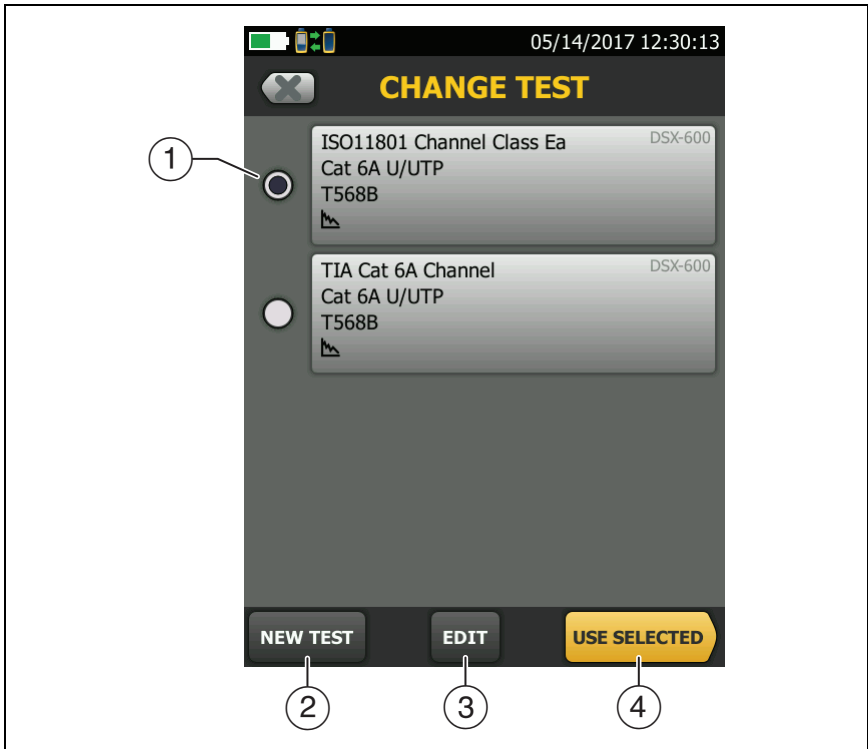

BA54.EPS

Figure 72. CHANGE TEST Screen

- ① To select a test, tap the test.
- ② To add a test to the project, tap **NEW TEST**.
- ③ To edit a test, tap the test, then tap **EDIT**.
- ④ To do the selected test, tap **USE SELECTED**, then tap **TEST** or press **TEST**.

Step 3: Do an Autotest

3-1 Attach the correct adapters to the main and remote testers.

3-2. Connect the testers to the cabling.

To do an Autotest without connections to installed cabling, connect the main and remote testers together with two channel adapters and twisted pair cable.

3-3. Tap **TEST** or press **TEST**. When the test is completed and if it passed, the tester automatically saves the results with the first ID in the set (B-00 in this example).

Step 4: Monitor the Status of Your Project

The home screen shows % **Tested**, which is the percentage completed of the total number of tests you must do for the project.

For example, in this tutorial you set up IDs with 12 tests.

If you did one Autotest on twisted pair for ID "B-00" as instructed by this tutorial, the % **Tested** shows **8%** (1 test completed out of 12 total for the project).

How to Change Settings as You Use a Project

To Change the ID

Sometimes you must use an ID that is not the next ID in the set, an ID that is not in the ID set, or an ID you used before. You can change the ID on the **CHANGE ID** screen before you do a test or enter the ID on the **SAVE RESULT** screen after you do a test.

To use a different, unused ID from an ID set that has a first and last ID

If **Auto Save** is on or off:

1 On the home screen, tap the **Next ID** panel.

- 2 On the **CHANGE ID** screen, tap an ID in the list under **IDs Untested**, then tap **DONE**.
- 3 Do the test. After you save the results, the tester uses the next ID in the set for the next results.

If **Auto Save** is off:

- 1 Do the test, then tap **SAVE** if the test passed or **FIX LATER** if the test failed.
- 2 Enter the ID on the **SAVE RESULT** screen, then tap **SAVE**. After you save the results, the tester uses the next ID in the set for the next results.

To use an ID you used before

- If the test failed before, turn on **Auto Save**, select the saved result on the **RESULTS** screen, then tap **TEST AGAIN** or press **TEST**. See “How to Make ID Sets” on page 165.
- If the test passed before, do the test again, then enter the ID on the **SAVE RESULT** screen.

To use an ID that is not in an ID set that has a first and last ID

If **Auto Save** is on or off:

- 1 On the home screen, tap the **Next ID** panel.
- 2 On the **CHANGE ID** screen, tap the panel that shows the **Next ID**.
- 3 Use the keyboard to enter an ID, then tap **DONE** on the keyboard.
- 4 The tester asks you if you want to create a new ID set (see “About Next ID Sets” on page 168). Tap **YES** in the dialog box, then tap **DONE**.
- 5 Do a test. The tester saves the results with the ID you entered. It saves subsequent results with the IDs from the new set.

To use IDs from the set you used before, go the **CHANGE ID** screen, tap **CHANGE CABLE IDs**, tap the ID set, then tap **USE SELECTED**.

If **Auto Save** is off:

- 1 Do the test, then tap **SAVE** if the test passed or **FIX LATER** if the test failed.
- 2 Enter an ID on the **SAVE RESULT** screen, then tap **SAVE**.

The tester saves the result with the ID you entered. The next ID the tester uses is the next ID from the set.

If the ID you used is in another set in the project, the tester removes that ID from the **IDs Untested** list for the same type of test.

If the ID you used is not in any set in the project, and the project contains one or more sets that have first and last IDs, the % **Tested** value includes test you saved with the ID. For example, if you have one set with 10 IDs, and you save 1 result with an ID that is not on the set, the % **Tested** shows 9% (1 saved result divided by 11 IDs).

To change the ID when the set has only a next ID

You can change the ID on the **CHANGE ID** screen before you do the test. Or, you can turn off **Auto Save**, then enter an ID on the **SAVE RESULT** screen after you do the test. For both methods, the tester changes the set to use the ID you entered as the **Next ID**.

To Change the Tests in a Project

When you use a project, you usually do only the tests that the project specifies. You select these tests from the list on the **CHANGE TEST** screen in the project.

If necessary, you can add a test to the project or change the settings for a test in the project.

To Select a Different Test in the Project

- 1 On the home screen, tap the test setup panel.
- 2 On the **CHANGE TEST** screen tap the test you want to do. See Figure 72 on page 161.
- 3 Tap **USE SELECTED**.

To Add a Test to a Project

- 1 On the home screen, tap the test setup panel or the **PROJECT** panel.
- 2 Tap **NEW TEST**.
- 3 On the **TEST SETUP** screen, change the test settings as necessary, then tap **SAVE**.

To Save Results in a Different or New Project

To save results in a different or new project, press home, tap the project panel, then tap **CHANGE PROJECT**. Select a different project, or tap **NEW PROJECT** to start a new project.

How to Make ID Sets

There are three methods you can use to make ID sets:

- Make sets of sequential IDs on the tester.
- Make sets of sequential IDs in LinkWare PC, download them to the tester, then import them into a project on the tester. See “Import an ID Set into a Project” on page 169. These sets can include non-sequential IDs.
- Make an ID set in a LinkWare Live project, then sync the project to the tester. See the help in LinkWare Live for details.

To make a set of sequential IDs, you enter the first and last ID in the set. The tester (or LinkWare PC software) increments the letters and numbers in the first ID from right to left to make a set of IDs that starts with your first ID and ends with your last ID. Special characters, letters with accents, and letters that are the same in the first and last IDs do not increment.

For example, here is an installation with 100 cables:

- Two floors: 17 and 18
- Fifty cables on each floor: cables 1 through 50

You can make this ID set for the installation:

First ID: FLOOR 17 CABLE 01

Last ID: FLOOR 18 CABLE 50

These IDs make this set of 100 IDs:

FLOOR 17 CABLE 01

FLOOR 17 CABLE 02

FLOOR 17 CABLE 03

⋮

FLOOR 17 CABLE 50

FLOOR 18 CABLE 01

FLOOR 18 CABLE 02

FLOOR 18 CABLE 03

⋮

FLOOR 18 CABLE 50

Each project can have up to 5000 IDs. If an ID set does not have a **Last ID**, the tester counts the set as one ID. An ID can have a maximum of 60 characters.

To make an ID set

Note

When you make an ID set, the tester saves it in the project shown on the home screen.

- 1 On the home screen, tap the **PROJECT** panel.
- 2 On the **PROJECT** screen, tap **NEW ID SET**.
- 3 On the **CABLE ID SETUP** screen, tap the **First ID** panel, then use the keyboard to enter the first ID for the set.
- 4 Tap the **Last ID** panel, use the keyboard to enter the last ID for the set, then tap **DONE**.

Note

*If you do not enter a **Last ID**, the tester uses the first ID as the **Next ID** and increments that ID each time you save a result. See "About Next ID Sets" on page 168.*

- 5 To see the ID set, tap **REVIEW**.
- 6 On the **CABLE ID REVIEW** screen or the **CABLE ID SETUP** screen, tap **Save**.

If an ID Sequence is Invalid

If an ID sequence is invalid, use these rules for valid sequences to find the problem:

- The **First** and **Last** IDs must have the same numbers of characters. For example you cannot use 1 as the **First ID** and 999 as the **Last ID**. A valid sequence is 001 to 999.
- An ID set cannot contain an ID used in another set.
- The types of characters in each position must agree between the **First** and **Last** IDs. For example:
 - You cannot use the letter "O" in the **First ID** and the number "0" in the same position in the **Last ID**.

- You cannot use “a” in the **First ID** and “D” in the same position in the **Last ID**. Both letters must be upper-case or lower-case.
- Do not use the characters / # * - . , : [], a space, or accented characters as characters to increment. You can use these characters in IDs, but they must be the same characters in the **First** and **Last** IDs.
- Characters in the **First ID** cannot be higher in their sequence than the related character in the **Last ID**. For example, you cannot use 2C as the **First ID** and 5A as the **Last ID**.
- IDs cannot have more than 60 characters.

About Next ID Sets

Next ID sets have one ID that the tester increments each time you do a test. To make a **Next ID** set, do not enter a **Last ID** when you make an ID set.

- Numbers increment sequentially:
1, 2, 3, 4, 5, 6, 7, 8, 9, 10, 11, 12, ... 99, 100, 101...
- Letters increment through the English alphabet:
A, B, C, D, ... Z, AA, AB, AC, AD, ... AZ, BA, BB, BC...
- Numbers and letters do not cause each other to increment:
1Y, 1Z, 1AA, 1AB, ... 1ZZ, 1AAA, 1AAB...
- The tester does not increment symbols or accented characters.

When you use a **Next ID** set, the set under **IDs Untested** on the **CHANGE ID** screen shows only the next ID. To save the next test with a different ID, tap the **Next ID:** panel, then enter a different ID.

Each project can have one **Next ID** set.

If your project has only a **Next ID** set, the tester cannot calculate the percentage of the project that is completed, so the **% Tested** value does not show on the home screen.

If your project has both a **Next ID** set and sets with first and last IDs, the % **Tested** value includes tests you saved with **Next ID**. For example, if you have one **Next ID** set and one set with 10 IDs, and you save 10 results with next IDs, the % **Tested** shows 50% (10 saved results divided by 20 IDs).

Import an ID Set into a Project

You can use LinkWare PC software to make ID sets, download them to the tester, then import them into projects.

Note

ID sets that you download to the tester must have the extension “.ids”.

To import an ID set

- 1 In LinkWare PC, select **Utilities > DSX CableAnalyzer > Create ID List** to make an ID set and download it to the tester.
- 2 On the home screen, tap the **PROJECT** panel.
- 3 Make sure the correct project shows on the **PROJECT** screen. If necessary, tap **CHANGE PROJECT** to select a different project.
- 4 On the **PROJECT** screen tap **NEW ID SET**, then tap **IMPORT**.
- 5 On the **IMPORT CABLE ID** screen, tap the ID set you downloaded.
- 6 Tap **IMPORT**.

Delete an Imported ID Set

If you go to the **PROJECT** screen and delete a cable ID set that you imported into the project, the ID set is still available in the tester.

To delete an imported ID set from the tester

- 1 In LinkWare PC, select **Utilities > DSX CableAnalyzer > Create ID List**.
- 2 In the **Custom ID List** dialog, click the **Delete List On Tester** icon, select a list, then click **OK**.

How to Manage Projects

Note

To manage projects in the cloud, use the LinkWare Live web application. See Chapter 9.

View Results in a Project

On the home screen, tap the **RESULTS** icon. To see the results from a different project, tap **VIEW ALL**, then tap a project name. For more information on results, see Chapter 7.

Rename a Project

- 1 On the home screen, tap the **PROJECT** panel, tap **MANAGE**, then tap **Rename**.
- 2 Use the keyboard to edit the name, then tap **DONE**.

Note

*You cannot rename the **DEFAULT** project.*

Copy a Project to Make a New Project

You can copy any project and change the settings to make a new project. When you copy a project, the new project does not contain the test results from the project you copied.

To copy a project

- 1 On the home screen, tap the **PROJECT** panel, tap **MANAGE**, then tap **Copy**.
- 2 Use the keyboard to enter a name for the project, then tap **DONE**.

Delete a Project

- 1 On the home screen, tap the **PROJECT** panel.
- 2 Make sure the project you want to delete is the active project. If it is not, tap **CHANGE PROJECT**, then select the project you want to delete.
- 3 On the **PROJECT** screen, tap **MANAGE**, then tap **Delete**. The tester shows a warning if you have not uploaded all of the results to a PC. Tap **DELETE** to delete the project.

Note

*You cannot delete the **DEFAULT** project.*

Manage Projects on a Flash Drive

You can export or import projects to or from a flash drive, and delete projects on the flash drive. The project data includes all project settings, test results, and ID sets.

Caution

- **Do not remove the USB flash drive while the LED on the drive flashes. Doing so can corrupt the data on the drive.**
- **You can lose a USB flash drive, cause damage to it, or accidentally erase the contents of the drive. Thus, Fluke Networks recommends that you save no more than one day of test results on a flash drive.**

Note

The tester reads only USB drives that use the FAT format.

- 1 Connect a USB flash drive to the type A USB port. The tester makes a bell sound when it detects the drive.
- 2 On the home screen, tap the **PROJECT** panel.
- 3 On the **PROJECT** screen, tap **TRANSFER**.

(continued)

- 4 On the **TRANSFER PROJECTS** screen, select a function:
 - **Export:** On the **EXPORT PROJECTS** screen, select the projects you want to export to the flash drive, then tap **EXPORT**.
 - **Import:** On the **IMPORT PROJECTS** screen select the projects you want to import from the flash drive, then tap **IMPORT**.
 - **Delete:** On the **DELETE PROJECTS** screen select the projects you want to delete on the flash drive, then tap **DELETE**.

Copy Project Settings to Other Testers

To copy the settings in a project to other DSX-600 testers, use the **Read Project Setups** and **Write Project Setups** utilities in LinkWare PC software. You can use LinkWare PC to read project settings from a tester or from a project you exported to a flash drive.

You can also use LinkWare Live to create projects that technicians in the field can download to their testers.

About LinkWare Live

The LinkWare Live web application lets you manage your results and projects from a desktop or mobile device, locate your DSX-600 testers in the field, and more. To get started with LinkWare live, see Chapter 9 or go to go to www.linkwarelive.com/signin.

Chapter 9: Sync Projects with LinkWare™ Live

The LinkWare Live web application lets you manage your projects from a desktop or mobile device.

Sign Up for a LinkWare Live Account

- 1 Go to www.linkwarelive.com/signin.
- 2 If you already have a LinkWare Live account, enter the email address and password on the LinkWare Live **Sign In** page.
- 3 If you do not have a LinkWare Live account, click **New user? Sign up Now!**. Enter the information for your account, then click **CREATE ACCOUNT**.
Fluke Networks sends you an email with a LinkWare Live activation code.
- 4 Open the email, copy the activation code, click the LinkWare Live activation link in the email, paste the activation code into the box in the activation window, then click **ACTIVATE**.
- 5 The LinkWare Live **Sign In** page shows again. Enter your email address and password, then click **SIGN IN**.

How to See the Tester's MAC Address

Some networks require users to register their device's MAC address before they can connect to the network.

There are two MAC addresses: one for the wired port and one for the Wi-Fi adapter.

To see the tester's or Wi-Fi adapter's MAC address

Note

The Wi-Fi adapter's MAC address is also provided on the adapter's package or with the adapter's documentation.

- 1 For a Wi-Fi adapter, connect the adapter to the tester's USB port.
- 2 On the home screen tap **TOOLS**, then tap **Network**.
- 3 On the **NETWORK** screen, tap the **Wired** or **Wi-Fi** panel. The MAC addresses shows at the top of the **WIRED** and **WI-FI PORT** screens.

Use LinkWare Live Through a Wired Ethernet Network

- 1 Use an appropriate cable to connect the tester's RJ45 Ethernet port to an active network port. If the cable is good and the port is active, the LEDs on the tester's port will come on.
- 2 On the home screen, make sure the **Operator** name is correct. The tester uses the email address associated with the operator name as the ID when you sign in to LinkWare Live.

If no address is associated with the name, or if you enter a different address on the **LWL SIGN IN** screen, the tester associates the name with the address you enter.

On the home screen, tap **SYNC**. When the tester connects to the network, the wired network connection icon shows at the top of the screen: 

- 3 On the **LWL SIGN IN** screen, if necessary, enter the ID and password for your LinkWare Live account, then tap **SIGN IN**. If you use other people's LinkWare Live accounts, the **ORGANIZATION** screen shows. Tap the organization you want to use.
- 4 On the **SYNC PROJECTS** screen (Figure 73 on page 177), select the projects you want to sync, then tap **SYNC**.

Use LinkWare Live Through a Wi-Fi Ethernet Network

To connect the tester to a Wi-Fi network, you must have an optional USB Wi-Fi adapter. Fluke Networks recommends these adapters:

- TP-LINK TL-WN725N
- NETGEAR WNA1000M

Other adapters may be suitable. For the latest list of qualified adapters, see this topic in the Fluke Networks Knowledge Base:

www.bit.ly/1ACJeFO

The tester can use wireless network channels 1 through 11.

- 1 Connect the Wi-Fi adapter to the tester's type A USB port.
- 2 On the home screen, make sure the **Operator** name is correct. The tester uses the email address associated with the operator name as the ID when you sign in to LinkWare Live.

If no address is associated with the name, or if you enter a different address on the **LWL SIGN IN** screen, the tester associates the name with the address you enter.

-continued-

3 On the home screen, tap **SYNC**.

4 Select a wireless network if necessary.

If the network setting are not correct, the tester shows the **NETWORK** screen and a message about the necessary settings.

a. To change the settings, tap the **Wi-Fi** panel.

b. To test the settings, go back to the **WI-FI PORT** screen, then tap **CONNECT**.

When the tester connects to the network, the Wi-Fi network connection icon shows at the top of the screen:



c. Go back to the **TRANSFER RESULTS** screen, then tap the **LinkWare Live** panel.

5 On the **LWL SIGN IN** screen, if necessary, enter the ID and password for your LinkWare Live account, then tap **SIGN IN**. Enter a user name and password for the network, if necessary.

6 If you use other people's LinkWare Live accounts, the **ORGANIZATION** screen shows. Tap the organization you want to use.

7 On the **SYNC PROJECTS** screen (Figure 73), select the projects you want to sync, then tap **SYNC**.

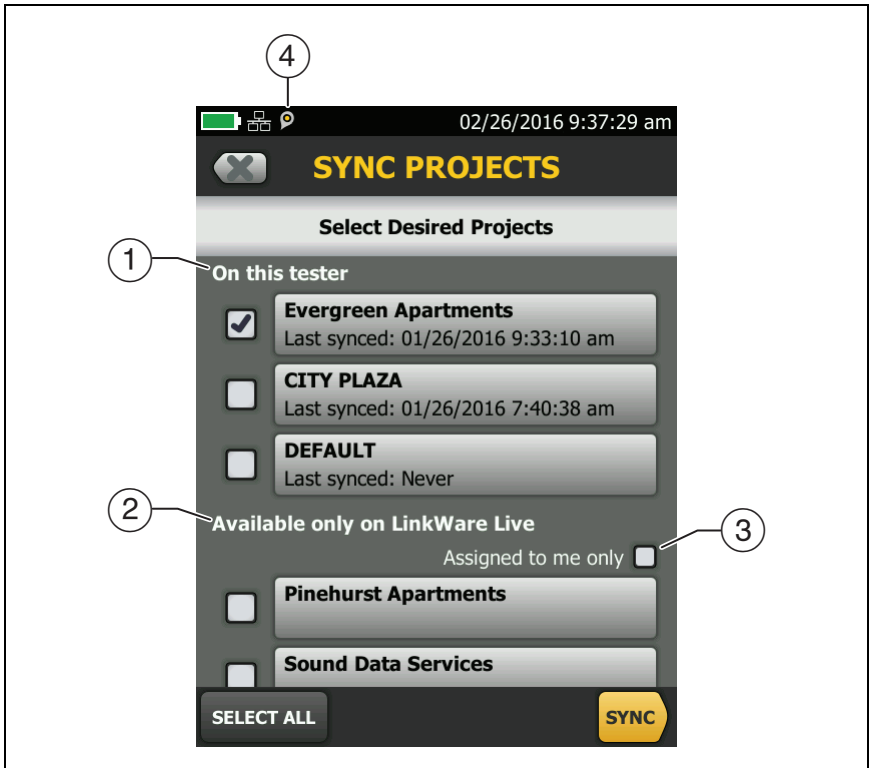

GPU190.EPS

Figure 73. SYNC PROJECTS Screen

- ① Projects in the **On this tester** section are possibly also in LinkWare Live. You can upload results from these projects to LinkWare Live.

If the project in LinkWare Live has test settings or cable IDs that are different from those in the tester, you can download the new settings to the tester.

By default, the active project is selected to sync.

- ② Projects in the **Available only on LinkWare Live** section have project settings you can download to the tester.

If you download these projects, only test settings and cable IDs are downloaded. Any test results saved in the project in LinkWare Live are not downloaded.

- ③ If you select **Assigned to me only**, you will see only projects that are assigned to you in the project settings in LinkWare Live.
- ④  The asset management icon shows when the owner of a LinkWare Live account has enabled the asset management service for the tester. See “About the Asset Management Service” on page 179.

Change the Network Settings

It is not usually necessary to change the wired or Wi-Fi network settings before you try to make a connection. But for example if you must use static addressing, you can get to the settings on the **NETWORK** screen.

To get to the network settings

On the home screen, tap **TOOLS**, then tap **Network**, then tap the **Wired** or **Wi-Fi** panel.

To test the settings

Tap **CONNECT** on the **WI-FI PORT** or **WIRED PORT** screen.

Settings for the Wired Port

The tester can use **DHCP** (dynamic host configuration protocol) or **Static** for the address method. Most networks use **DHCP**.

For **Static**, enter an IP address for the tester and the **Subnet Mask**, **Gateway** address, and **DNS1** and **DNS2** addresses for the network. If you are not sure what to enter, speak to the network administrator.

Settings for the Wi-Fi Port

Table 9 shows the Wi-Fi settings.

Delete Wi-Fi Settings and Passwords

The tester saves the security settings and passwords for the Wi-Fi connections you use.

To delete all Wi-Fi settings and passwords

On the home screen, tap **TOOLS**, then tap **Network**, tap the **Wi-Fi** panel, then tap **FORGET ALL**.

About the Asset Management Service

LinkWare Live's asset management service lets you see the locations of your DSX-600 testers in the field. The owner of the LinkWare Live account can enable or disable the service remotely for each DSX-600 tester.

When this service is enabled on a DSX-600 tester, the asset management icon () shows on the tester's home screen. When a technician uses the tester to sign in to LinkWare Live, the tester's location shows on a map on LinkWare Live's **ASSETS** page.

Note

You can enable or disable the asset management service only with LinkWare Live. There is no setting on the DSX-600 tester that enables or disables this service.

Sign Your Tester Out of LinkWare Live

- 1 On the home screen, tap the **TOOLS** icon, then tap **Sign In**.
- 2 On the **LWL SIGN IN** screen, tap **SIGN OUT**.

Or, turn off the tester.

Table 9. Settings for the Wi-Fi Connection

Setting	Description
Address	Most networks use DHCP .
DHCP address settings	<p>SSID: The tester does a scan for wireless networks and shows a list of available networks. Select the correct SSID.</p> <p>To connect to a hidden network, tap ADD SSID.</p> <p>Security:</p> <ul style="list-style-type: none"> • Authentication: Select the authentication type that the network uses: • Open: Security credentials are not necessary. • WEP: Select an encryption method and enter the necessary keys. • WPA/WPA2 Personal: Enter the password for the network. • WPA/WPA2 Enterprise: <ul style="list-style-type: none"> ♦ EAP: Select an EAP type that is appropriate for the authentication server. ♦ User and Password: Enter a user name (login name) and password for the network. ♦ Alternate ID: The tester can use the Alternate ID with some EAP methods to send an empty or anonymous identity while the tester makes a private connection. The tester then uses the private connection to send the User name and Password you entered. <p>The tester can also use the Alternate ID to send the User name and Password to an authentication server in a different realm. In this situation, the Alternate ID can have a format such as anonymous@MyCompany.com or / MyCompany/anonymous.</p>
Static address settings	<p>Enter an IP address for the tester and the Subnet Mask, Gateway address, and DNS1 and DNS2 addresses for the network. If you are not sure what to enter, speak to the network administrator.</p> <p>The Security settings are the same as for the DHCP address settings.</p>

Sign In to LinkWare Live from a Desktop or Mobile Device

- 1 Go to <https://www.linkwarelive.com/signin>.
- 2 Enter your LinkWare Live user name and password, then click **SIGN IN**.

For more information about how to use LinkWare Live, click **HELP** on the LinkWare Live web page.

Import Projects from LinkWare Live into LinkWare PC

- 1 Install the latest version of LinkWare PC software on the PC.
- 2 Turn on the tester and start LinkWare PC.
- 3 On the LinkWare PC toolbar, click . The icon is a red square with a white 'Lw' inside a yellow square.
- 4 Sign in to LinkWare Live, then use the LinkWare PC dialog boxes to select and import projects.

For More Information on LinkWare Live

For more information on LinkWare Live, see the LinkWare Live product page on the Fluke Networks website.

Chapter 10: Custom Media and Test Limits

Make a Custom Copper Cable Type

If a twisted pair or coaxial cable installation has a cable type that is not in the list of types in the tester, you can make a custom cable type for the job. A custom cable type has these settings:

- Custom cable name
- Standard cable type used for default values
- NVP (nominal velocity of propagation)

You can make up to 20 custom cable types. The tester keeps custom cable types with the other cable types in the main DSX-600 unit. The names of custom cable types have an asterisk (*) at the start and end.

Use the values specified by the cable manufacturer to make the custom cable type.

To make a custom cable type

- 1 On the home screen, tap the test setup panel.
- 2 On the **CHANGE TEST** screen, tap a copper test, then tap **EDIT**.

Note

You must select a test before you make a custom cable type, but you can use the cable type in any test that supports the category of the cable.

- 3 On the **TEST SETUP** screen, tap **Cable Type**, tap **MORE**, tap **Custom**, then tap **MANAGE**.
- 4 On the **MANAGE CUSTOM** screen, tap the **Create** panel.

-continued-

- 5 On the **NEW CUSTOM CABLE** screen, tap **Enter New Cable Name**, use the keyboard to enter a name, then tap **DONE**.
- 6 On the **NEW CUSTOM CABLE** screen, tap the panel under **Use default values from:**, then select a cable type to use for default values for your custom cable.
- 7 On the **NEW CUSTOM CABLE** screen, tap the **NVP** panel to change the NVP value if necessary. See the next section for instructions.
- 8 When you have entered all necessary values, tap **SAVE** on the **NEW CUSTOM CABLE** screen. The tester adds an asterisk (*) to the start and end of the custom cable name.
- 9 To use the custom cable type, tap it on the **CABLE TYPE** screen.

Change the NVP

The tester uses an NVP value (nominal velocity of propagation) and the signal delay through a cable to calculate the length of copper cabling.

The default value specified by the selected cable type is the typical NVP for that cable type. The default value is usually accurate enough for cable certification tests. To increase the accuracy of length measurements you can adjust the NVP to a specified or actual value.

Note

NVP values can be different among cable types, lots, and manufacturers. Usually, these differences are not large enough to change the PASS/FAIL result of the length test.



Set the NVP to a Specified Value

Use this procedure to set the NVP to a specified value, such as the value specified by the manufacturer. The NVP value applies to the selected cable type.

Note

*If you are on the **NEW CUSTOM CABLE** screen, tap the **NVP** panel, then go to step 4 below.*

To enter a specified NVP value

- 1 On the home screen, tap the test setup panel, tap a copper test, then tap **EDIT**.
- 2 On the **TEST SETUP** screen, make sure that the **Cable Type** is correct.
- 3 Under the **Cable Type**, tap **NVP**.
- 4 On the **NVP** screen, use  or  to change the NVP value.
- 5 Tap **DONE**, then tap **SAVE**.

Find a Cable's Actual NVP

To find a cable's actual NVP, you can use the **NVP** screen to adjust the measured length to match a known length of cable. The NVP value applies to the selected cable type.



To find a cable's NVP

Note

*If you are on the **NEW CUSTOM CABLE** screen, tap the **NVP** panel, then go to step 4 below.*

- 1 On the home screen, tap the test setup panel, tap a copper test, then tap **EDIT**.
- 2 On the **TEST SETUP** screen, make sure that the **Cable Type** is correct.
- 3 Under the **Cable Type**, tap **NVP**.
- 4 Attach a channel adapter to the tester.
- 5 Connect a known length of twisted pair cable to the tester. The cable must be a minimum of 30 m (100 ft) long.

-continued-

- 6 Tap **MEASURE**.
- 7 On the **NVP** screen, use  or  to change the NVP value until the measured length is the length of the cable, then tap **SAVE**.

Reset the NVP to the Default Value

To reset the NVP to the default value defined by the selected cable type, select the cable type again on the **TEST SETUP** screen.

Make a Custom Outlet Configuration

Custom outlet configurations start with the T568A or T568B configurations. You can enable or disable each pair, and give the configuration a name.

To make a custom outlet configuration

- 1 On the home screen, tap the test setup panel, tap a copper test, then tap **EDIT**.
- 2 On the **TEST SETUP** screen, tap **Outlet Configuration**.
- 3 Tap **CUSTOM**, then tap **MANAGE**, then tap the **Create** panel.
- 4 Select the **T568A** or **T568B** configuration then select the pairs you want enabled.
- 5 Enter a name for the configuration, then tap **SAVE**. The tester adds an asterisk (*) to the start and end of the custom configuration name.
- 6 To use the configuration, tap it on the **OUTLET CONFIG** screen, then tap **USE SELECTED**.

Note

*When you disable pairs, the overall test result can be **PASS** when some enabled pairs do not comply with the selected test limit. For example, if you disable pair 4,5, the NEXT test results will not show how crosstalk from the other pairs would affect pair 4,5. Thus, other pairs could possibly not be fully compliant with the test limit.*

Chapter 11: Maintenance

Warning

To prevent possible fire, electric shock, personal injury, or damage to the tester:

- Do not open the case. You cannot repair or replace parts in the case.
- Use only replacement parts that are approved by Fluke Networks.
- If you replace parts that are not specified as replacement parts, the warranty will not apply to the product and you can make the product dangerous to use.
- Use only service centers that are approved by Fluke Networks.

Caution

If you replace electrical parts yourself, the tester will possibly not have the correct calibration and can give incorrect test results. If the calibration is not correct, cable manufacturers can remove their warranty from the cabling you install.

Verify Operation

The tester does a self test when you turn it on. If the tester shows an error or does not turn on, refer to “If the Tester Does Not Operate as Usual” on page 200.

Clean the Tester

To clean the touchscreen, turn off the tester, then use a soft, lint-free cloth that is moist with water or water and a mild detergent.

To clean the case, use a soft cloth that is moist with water or water and a mild detergent.



Do not put the tester or the battery pack in water.



To prevent damage to the touchscreen or the case, do not use solvents or abrasive materials.

When you clean the touchscreen or the case, do not let liquid get under the plastic around the touchscreen.

See Information About the Tester

To see information about your tester and attached adapters

On the home screen, tap the **TOOLS** icon, then tap **Version Information**. See Figure 74.

To see information about a remote tester

Use a patch cord to connect the main and remote testers together (see Figure 4 on page 17), then tap **REMOTE** on the **Version Information** screen.

Refer to Figure 74:

- ① If the tester is connected to a wired network through the Ethernet jack on the side of the tester, the IP address of the tester shows.
- ② The serial number and the software and hardware versions of the device.

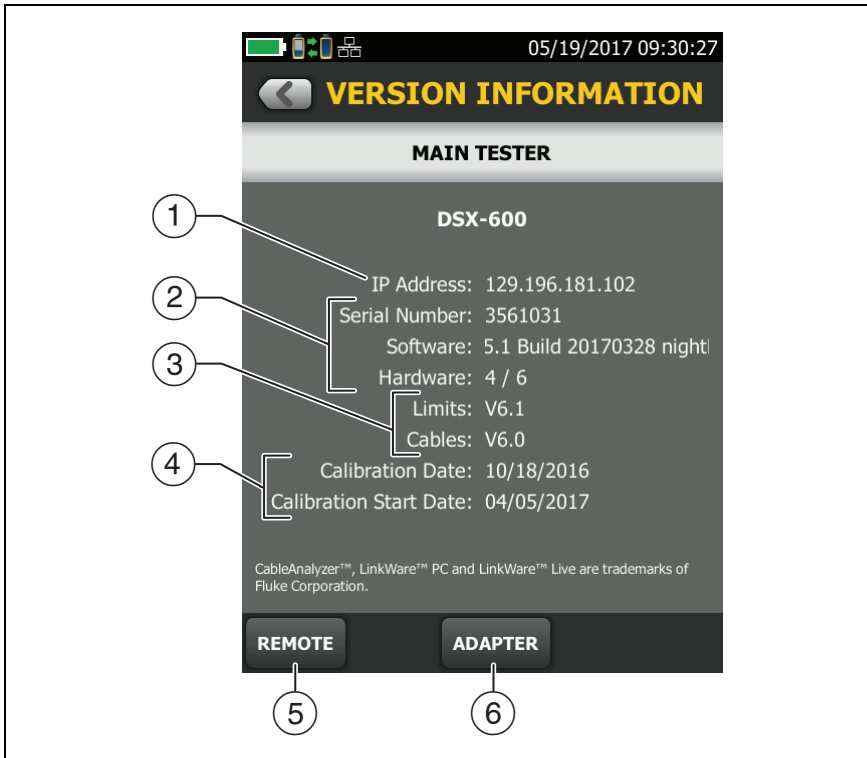

BAS7.EPS

Figure 74. VERSION INFORMATION Screen for the Main Tester

- ③ The versions of the databases for test limits and cable types. These databases are part of the software version installed in the main tester.
- ④ The **Calibration Date** is the date when the tester was calibrated at a Fluke Networks factory or service center.

If the tester was used for the first time within 6 months after it was calibrated during manufacturing, **Calibration Start Date** shows. This is the date the tester was first used. This is typical for new testers.

If the first use was more than 6 months after calibration, the **Calibration Start Date** is the date the tester was calibrated, plus 6 months. For example, if the tester was manufactured and calibrated on February 1st, 2015, but not used until October 1st, 2015, the **Calibration Start Date** is August 1st, 2015.

To keep the tester in calibration, send it to an authorized service center within 12 months of the **Calibration Start Date** (or the **Calibration Date** if the **Calibration Start Date** is not shown).

- ⑤ If a remote tester is connected to the main tester, tap **REMOTE** to see information about the remote tester.
- ⑥ If a link interface adapter is attached to the tester, you can tap **ADAPTER** to see this information about the adapter:
 - **Serial Number** and the **Hardware** version of the adapter.
 - **Autotest Count** is the number of Autotests done with the adapter. You can use this count to monitor the wear on the adapter's jack or plug.
 - **Current Series** is an Autotest count that you can reset. To reset the counter, tap **Reset Series**.

Update the Software

New software gives you access to new features and the latest test limits and cable types. Software updates are available on the Fluke Networks website.

You can use a PC to install a software update, or connect an updated main tester to a remote or to another main tester to update those testers.

You can also use LinkWare Live to download a software update from the cloud to your main tester, then use the main tester and a USB cable to install the update in the remote.

Use a PC to Update the Software

Caution

To prevent unexpected loss of power, connect the ac adapter to the tester when you update the software.

Note

The software update procedure does not delete the test records, project settings, or user preferences in the tester, but can possibly change the factory-installed cable types or test limits.

- 1 Install the latest version of LinkWare PC software on your PC. LinkWare PC is available on the Fluke Networks website.
- 2 Connect the Micro-AB USB port on the tester to a USB port on the PC. See Figure 75.
- 3 LinkWare PC automatically tells you if new software for the tester is available on the Fluke Networks website, and lets you install the software.

Note

Older versions of LinkWare PC do not start the update procedure automatically. For older versions, you must have the software update file on a disk or USB drive and click  to start the update procedure.

- 4 The tester reboots when the update is completed. To make sure the update was installed correctly, tap the **TOOLS** icon on the home screen, tap **Version Information**, then make sure the correct version shows.
- 5 If you have a DSX-600 remote, do steps 2 through 4 again for the remote tester.

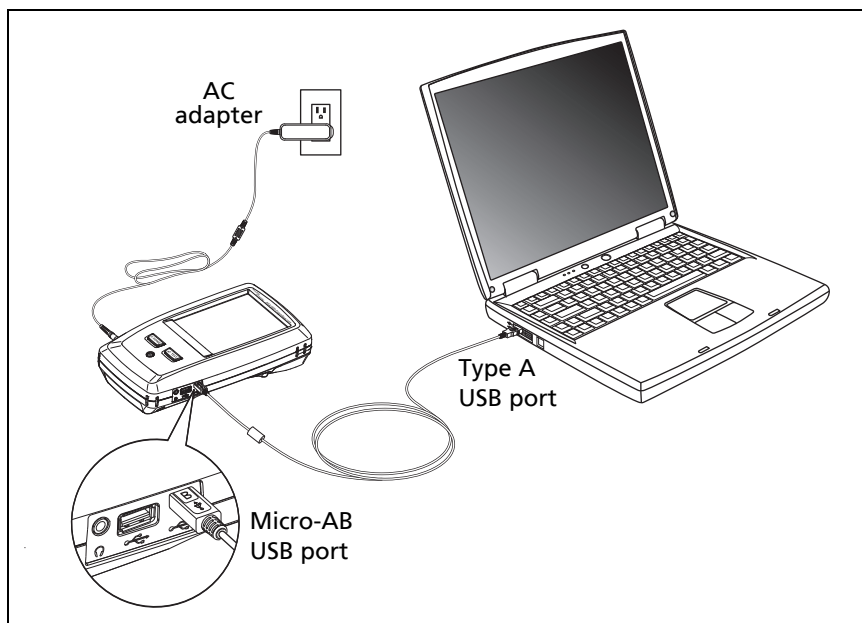

Figure 75. How to Connect the Tester to a PC

BA46.EPS

Use an Updated Main Tester to Update Other Testers

- 1 Turn on both testers and connect the AC adapters to both testers.
- 2 Use the USB cable provided to connect the updated main tester to the remote or to another main. See Figure 76.
- 3 Follow the instructions shown on the display of the updated main tester.

Note

If a remote has newer software than the main tester, the main tester can install the older software in the remote so that you can use the two testers together. The remote cannot install the newer software in the main tester.

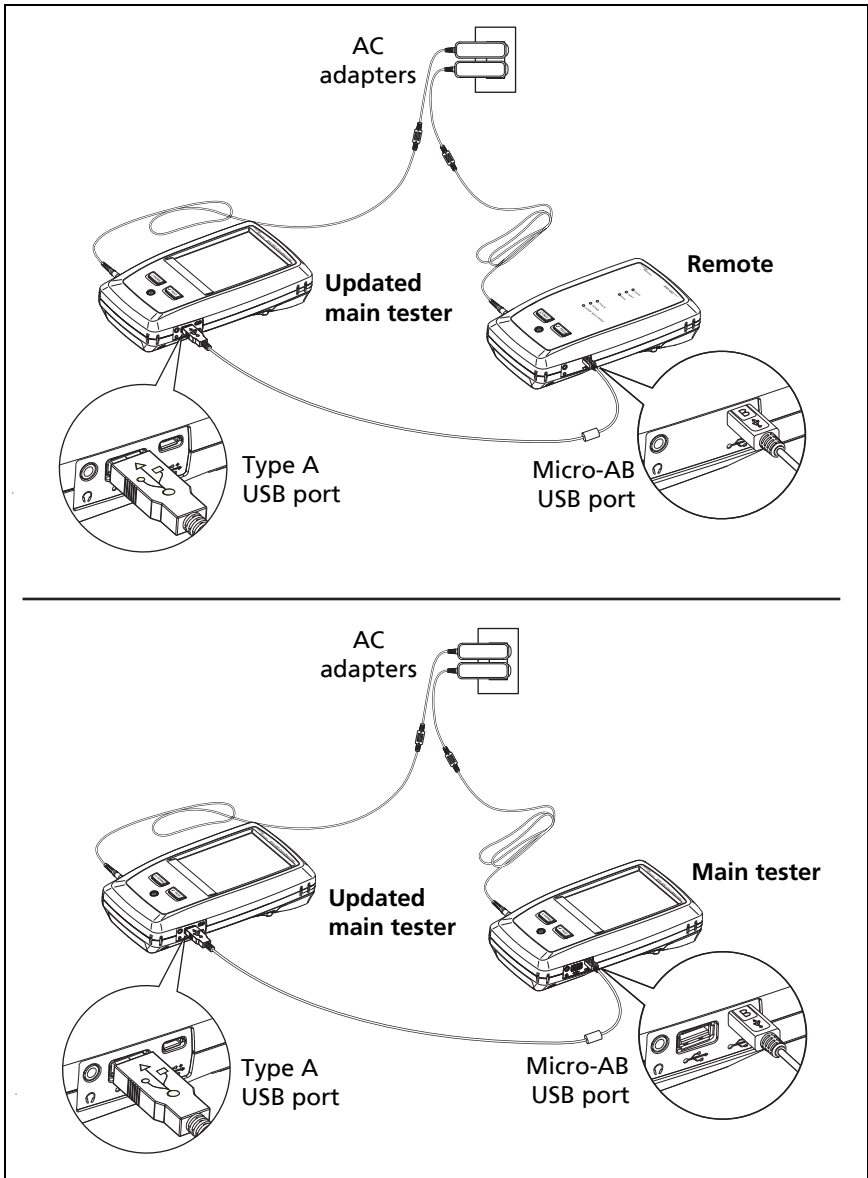

BA116.EPS

Figure 76. How to Connect Testers Together to Update the Software

Use LinkWare Live to Update the Software

- 1 Use an appropriate cable to connect the tester's RJ45 Ethernet port to a network port or connect a Wi-Fi adapter to the tester's type A USB port.
- 2 On the home screen, tap **SYNC**.
- 3 For a wireless network, if the network selection screen shows, connect to a network:
 - a. Select a network.
 - b. Enter security information.
 - c. Go back to the previous screen, then tap **CONNECT**.
 - d. Go back to the home screen, then tap **SYNC**.
- 4 On the **LWL SIGN IN** screen, enter the ID and password for your LinkWare Live account, then tap **SIGN IN**.
- 5 If a software update is available, the tester shows a message. Tap **YES** to install new software in your tester.
- 6 The tester reboots when the update is completed.
- 7 To install the update in a remote or another main tester, use the USB cable provided to connect the updated main tester to the other tester. See Figure 76.
- 8 Follow the instructions shown on the display of the updated main tester.

Extend the Life of the Battery

Warning

To prevent possible fire, electric shock, or personal injury, read the warnings about the rechargeable battery under “ Safety Information” on page 4.

- Do not frequently let the battery discharge completely.
- Do not keep the battery at temperatures below -20 °C (-4 °F) or above +50 °C (+122 °F) for periods longer than one week.
- Before you put a battery into storage, charge it to approximately 50 % of full charge.

Store the Tester

- Before you store a tester or an extra battery for a long period, charge the battery to approximately 50 % of full charge. The discharge rate of the battery is 5 % to 10 % each month. Check the battery every 4 months and charge it if necessary.
- Keep a battery attached to the tester during storage. If you remove the battery for more than approximately 24 hours, the tester will not keep the correct time and date.
- See “Environmental and Regulatory Specifications” on page 203 for storage temperatures.

Remove the Battery

Figure 77 shows how to remove the battery.

Notes

If you remove the battery and do not connect the ac adapter, the clock keeps the current date and time for a minimum of 24 hours.

The screw does not come out of the battery door.

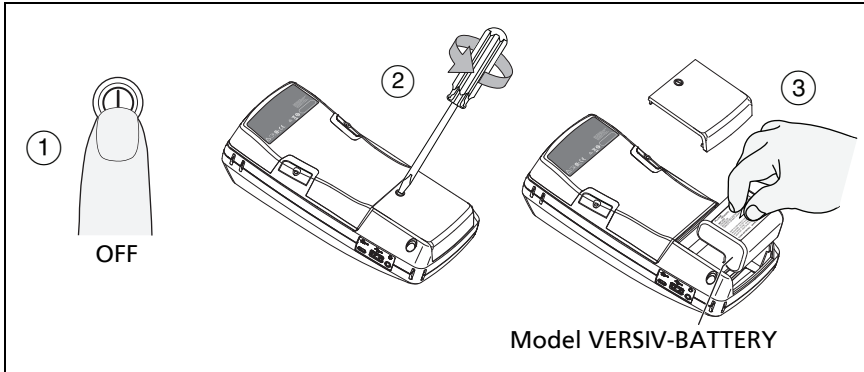

Figure 77. How to Remove the Battery

Replace the Tip on a DSX-PLA004 Connector

Over time, the gold plating on the DSX-PLA004 adapter's RJ45 connector's contacts becomes worn. This can cause test result margins to shrink. Damage to the contacts can also cause problems with tests.

When margins begin to shrink, or if the RJ45 tip is damaged, replace the tip with a new one. New tips are available in the DTX-PLA002PRP replacement parts kit. The connector's latch can also become worn, so the parts kit also includes replacement latches.

To replace the tip and latch

- 1 Remove the adapter from the tester.
- 2 Use a Phillips screwdriver to loosen the screw on the connector case; then remove and replace the tip or latch as shown in Figure 78.
- 3 Make sure that the conductive washer is on the case screw as shown below.
- 4 Reassemble the connector case, then tighten the screw.

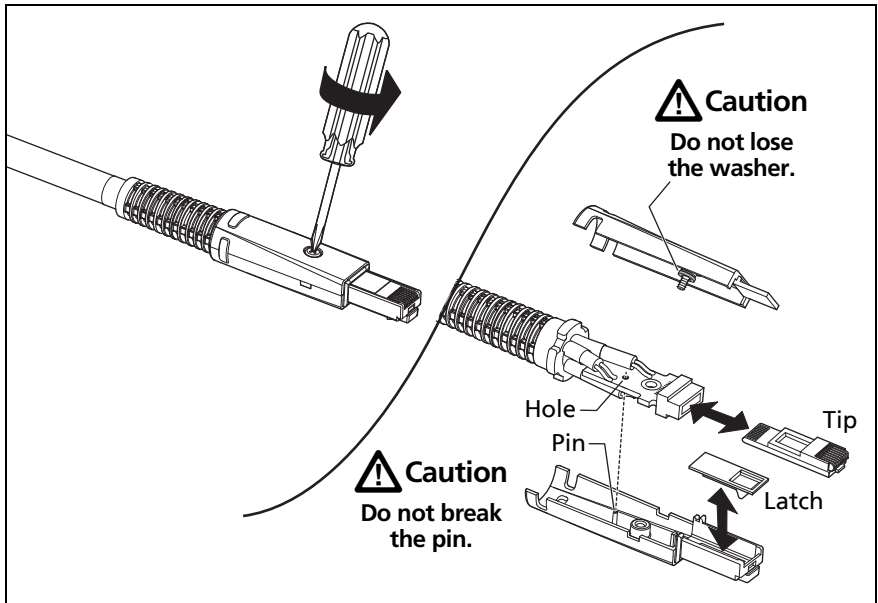

GPU203.EPS

Figure 78. How to Replace the DSX-PLA004 Adapter's Tip and Latch

Traceable Calibration Period

To make sure that the testers operate within the published specifications for accuracy, have them calibrated at a Fluke Networks authorized service center every 12 months. To get information on factory calibration, contact an authorized Fluke Networks Service Center.

To see when the tester last received a factory calibration, tap the **TOOLS** icon on the home screen, then tap **Version Information**.

Options and Accessories

For a complete list of options and accessories go to the Fluke Networks website at www.flukenetworks.com.

To order options and accessories, contact an authorized Fluke Networks distributor.

If the Tester Does Not Operate as Usual

If the tester does not operate as usual or if it shows an unusual message, see Table 10 for possible explanations and solutions to some conditions that can occur.

If the condition continues, contact Fluke Networks for assistance, or search the Fluke Networks Knowledge Base for a solution.

If you contact Fluke Networks, have available the serial number, software and hardware versions, and calibration date for the tester, if possible. To see this information, tap the **TOOLS** icon on the home screen, then tap **Version Information**.

You can also use LinkWare PC software to upload the system log from the tester. This file contains information that can possibly help Fluke Networks find a solution to an unusual problem.

The serial numbers of the main and remote units are on a sticker on the back of the units.

Table 10. Possible Solutions for Unusual Behavior

<p>The touchscreen or the keys do not respond.</p>
<p>Press and hold  until the tester turns off. Then turn on the tester. If the problem continues, install the latest version of software in the tester.</p>
<p>The tester will not turn on even though the battery is charged.</p>
<p>The safety switch or the fuse in the battery is possibly open. Wait a few seconds, then try again. If the tester does not turn on, the battery is possibly bad and must be replaced. The tester can operate on AC power if the battery does not operate.</p>

Table 10. Possible Solutions for Unusual Behavior (continued)

Test results appear to be incorrect.

The tester possibly has incorrect settings. Make sure you selected the correct cable type and test limit.

Chapter 12: Specifications

Notes

Specifications can change without notice. For the latest specifications, go to the Fluke Networks website.

Specifications apply at 23 °C (73 °F), unless otherwise noted.

Environmental and Regulatory Specifications

Operating temperature ^{1, 2}	32 °F to 113 °F (0 °C to 45 °C)
Storage temperature ³	With battery: 14 °F to +140 °F (-10 °C to +60 °C) Without battery: -22 °F to +140 °F (-30 °C to +60 °C)
Operating relative humidity (% RH without condensation)	0 % to 90 %, 32 °F to 95 °F (0 °C to 35 °C) 0 % to 70 %, 95 °F to 113 °F (35 °C to 45 °C)
Vibration	Random, 2 g, 5 Hz-500 Hz
Shock	1 m drop test with and without adapter
Safety	CSA 22.2 No. 61010, IEC 61010-1 3rd Edition
Operating altitude	13,123 ft (4,000 m) 10,500 ft (3,200 m) with ac adapter
Storage altitude	39,370 ft (12,000 m)
Pollution degree	2
<ol style="list-style-type: none">1. Using battery power. With ac power: 0 °C to 45 °C.2. The battery will not charge if its temperature is outside the range of 32 °F to 104 °F (0 °C to 40 °C).3. Do not keep the battery at temperatures below -20 °C (-4 °F) or above +50 °C (+122 °F) for periods longer than one week. If you do, the battery capacity can decrease.	

Performance Specifications

Note

Specifications for tests on twisted pair cabling apply to 100 Ω cable. For information on measurement performance for cable with a different impedance, contact Fluke Networks.

Times for a Full, 2-Way Autotest

Category	Autotest Time ^{1,2,3}
Cat 5e or 6/Class D or E	< 9 seconds
Cat 6A/Class E _A	10 seconds
ISO 11801 PL Class E	< 15 seconds
<ol style="list-style-type: none">1. On unshielded cable. Autotests on shielded cable take approximately 0.6 seconds longer.2. The first Autotest after power-on takes approximately 1.5 seconds longer. If the Autotest includes common-mode measurements, add 0.8 seconds more.3. AC wire map function adds approximately 3 seconds to Autotest times.	

Tests and Frequencies Supported

Twisted Pair Cabling

- TIA Cat 3, 4, 5, 5e, 6, 6A certification per TIA 568-C.2
- ISO/IEC Class C and D, E, E_A certification per ISO/IEC 11801:2002 and amendments
- Maximum frequency: 500 MHz

Coaxial Cabling (optional DSX-CHA003 coaxial adapters required)

- DS3, CATV, 10BASE-2, 10BASE-5, generic coaxial cable
- Maximum frequency: 500 MHz

Standard Link Interface Adapters

DSX-CHA004 Class E_A Channel Adapters

- Jack type and life: shielded RJ45, 8-pin modular, >5000 insertions
- Tests supported: shielded and unshielded cable, TIA Cat 3, 4, 5, 5e, 6, and 6A and ISO/IEC Class C, D, E, and E_A channels

DSX-PLA004 Class E_A Permanent Link Adapters

- Plug type and life: shielded RJ45, 8-pin modular, >5000 insertions, on a 5 ft (1.5 m) cable
- Tests supported: shielded and unshielded cable, TIA Cat 3, 4, 5, 5e, 6, and 6A, and ISO/IEC Class C, D, E, and E_A permanent links

Measurement Accuracy

For Category 6A/Class E_A tests, the DSX-600 CableAnalyzer is compliant with Level IIIe requirements of TIA 1152 and Level IV of IEC 61935-1.

Worst case accuracy performance parameters are used for asterisk (*) results reporting. These are based on computation of the overall measurement accuracy based on the worst case of each parameter at each frequency data point. Observed differences between laboratory equipment and DSX-600 CableAnalyzer testers using calibration verification artifacts were used as a confirmation.

The next table shows the accuracy performance parameters for the DSX-600.

**DSX-600 Level V Accuracy Performance Parameters
 per IEC Guidelines**

Parameter	Baseline Field Tester	Field Tester with Level V Permanent Link Adapter	Field Tester with Level V Channel Adapter
Dynamic range	3 dB over test limit NEXT and FEXT 65 dB PS NEXT and FEXT 62 dB		
Amplitude resolution	0.1 dB		
Frequency range and resolution	1 to 31.25 MHz: 150 kHz 31.25 to 100 MHz: 250 kHz 100 to 250 MHz: 500 kHz 250 to 500 MHz: 1 MHz		
Dynamic Accuracy NEXT	± 0.75 dB		

**DSX-600 Level V Accuracy Performance Parameters
per IEC Guidelines (continued)**

Parameter	Baseline Field Tester	Field Tester with Level V Permanent Link Adapter	Field Tester with Level V Channel Adapter
Dynamic Accuracy ACR-F	± 1.0 dB (FEXT dynamic accuracy is tested to ± 0.75 dB)		
Source/load return loss	1 to 300 MHz: $20 - 12.5 \log(f/100)$, 20 dB maximum 300 to 500 MHz: 14 dB	1 to 300 MHz: $18 - 12.5 \log(f/100)$, 20 dB maximum 300 to 500 MHz: 12 dB	
Random Noise Floor	95 dB	90 dB	
Residual NEXT	$90 - 20 \log(f/100)$ (measured to 85 dB maximum)	$85 - 20 \log(f/100)$ (measured to 85 dB maximum)	1 to 500 MHz: $82.3 - 20 \log(f/100)$ (measured to 85 dB maximum)
Residual FEXT	$80 - 20 \log(f/100)$ (measured to 85 dB maximum)	$75 - 20 \log(f/100)$ (measured to 85 dB maximum)	$60 - 15 \log(f/100)$ (measured to 85 dB maximum)
Output Signal Balance	1 to 500 MHz: $40 - 20 \log(f/100)$ (measured to 60 dB maximum)	1 to 500 MHz: $37 - 20 \log(f/100)$ (measured to 60 dB maximum)	
Common Mode Rejection	$40 - 20 \log(f/100)$ (measured to 60 dB maximum)	$37 - 20 \log(f/100)$ (measured to 60 dB maximum)	
Tracking	± 0.5 dB (applicable when IL > 3 dB)		

-continued-

**DSX-600 Level V Accuracy Performance Parameters
 per IEC Guidelines (continued)**

Parameter	Baseline Field Tester	Field Tester with Level V Permanent Link Adapter	Field Tester with Level V Channel Adapter
Directivity	1 to 300 MHz: 27 - 7log(f/100), 30 dB maximum 300 to 500 MHz: 23.7 dB (applicable when IL > 3 dB)	1 to 300 MHz: 25 - 7 log(f/100), 30 dB maximum 300 to 500 MHz: 21.7 dB (applicable when IL > 3 dB)	
Source Match	20 dB (applicable when IL > 3dB)		
Return loss of Termination	1 to 250 MHz: 20 - 15log(f/100), 25 dB maximum 250 to 500 MHz: 14 dB (applicable when IL > 3 dB)	1 to 250 MHz: 18 - 15 log(f/100), 25 dB maximum 250 to 500 MHz: 12 dB (applicable when IL > 3 dB)	

Length of Twisted Pair Cabling

Note

Length specifications do not include the uncertainty of the cable's NVP value.

Parameter	Twisted Pair Cabling	
	Without Remote	With Remote
Range	800 m (2600 ft)	150 m (490 ft)
Resolution	0.1 m or 1 ft	0.1 m or 1 ft
Accuracy	± (0.3 m + 2 %); 0 m to 150 m ± (0.3 m + 4 %); 150 m to 800 m	± (0.3 m + 2 %)

Propagation Delay

Parameter	Twisted Pair Cabling	
	Without Remote	With Remote
Range	4000 ns	750 ns
Resolution	1 ns	1 ns
Accuracy	$\pm (2 \text{ ns} + 2 \%)$; 0 ns to 750 ns $\pm (2 \text{ ns} + 4 \%)$; 750 ns to 4000 ns	$\pm (2 \text{ ns} + 2 \%)$

Delay Skew

Parameter	Twisted Pair Cabling
Range	0 ns to 100 ns
Resolution	1 ns
Accuracy	$\pm 10 \text{ ns}$

DC Loop Resistance

Parameter	Twisted Pair Cabling
Range	0 Ω to 540 Ω
Resolution	0.1 Ω
Accuracy	$\pm (1 \Omega + 1 \%)$
Overload Recovery Time	Less than 10 minutes to rated accuracy following an overvoltage. Referencing is required after repeated or prolonged overvoltage.

HDTDX Analyzer Specifications for Cables <100 m (328 ft)

Parameter	Twisted Pair Cabling
Distance accuracy	$\pm (0.3 \text{ m (1 ft)} + 2 \% \text{ distance})$

Distance resolution	0.1 m or 1 ft
---------------------	---------------

HDTDR Analyzer Specifications for Cables <100 m (328 ft)

Parameter	Twisted Pair Cabling
Distance accuracy	$\pm (0.3 \text{ m (1 ft)} + 2 \% \text{ distance})$
Distance resolution	0.1 m or 1 ft

Characteristic Impedance

The tester gives an estimate of the cable's impedance at 4 m from the start of the link. The accuracy of the measurement is relative to a 100 Ω terminating resistance.

Parameter	Twisted Pair Cabling
Range	70 Ω - 180 Ω
Accuracy	$\pm (5 \Omega + 5 \% \text{ of } 100 \Omega - \text{Measured})$
Resolution	1 Ω

Tone Generator

Generates tones that can be detected by a tone probe, such as a Fluke Networks IntelliTone™ probe. The tones are on all pairs. The tone generator does not generate the IntelliTone signal.

The tone generator also turns on an inactive main or remote DSX-600 CableAnalyzer connected to the other end of the cable.

Input Protection

Protected against continuous telco voltages and 100 mA over-current. Occasional ISDN over-voltages will not cause damage.

Power

Battery type	Lithium ion battery pack, 7.2 V
Battery life	8 hr typical
Charge time	Tester off: 4 hours to charge from 10 % capacity to 90 % capacity. Tester on: 6 hours to charge from 10 % capacity to 90 % capacity with the tester on.
Power Adapter	Input: 100 to 240 VAC \pm 10%, 50/60Hz Output: 15 VDC, 2 A maximum, Class II

Traceable Calibration Period

To make sure that the testers operate within the published specifications for accuracy, have them calibrated at a Fluke Networks authorized service center every 12 months.

DSX-CHA003 Coaxial Adapter

Connector	Male F-connector. BNC adapter allows connection to coaxial network cabling
Cable types tested	Coaxial video and network cabling
Length	Range: 490 ft (150 m) Resolution: 0.1 m or 1 ft Accuracy: 0 m to 150 m (0 ft to 492 ft): $\pm(0.3 \text{ m} + 2 \%)$
Propagation delay	Range: 750 ns Resolution: 1 ns Accuracy: 0 ns to 750 ns: $\pm(2 \text{ ns} + 2\%)$
Loop resistance	Range: 0 Ω to 530 Ω Resolution: 0.1 Ω Accuracy: $\pm(1 \Omega + 1 \%)$
Insertion loss Frequency range and resolution Source/load return loss (typical) (75 Ω reference impedance) Random noise floor (typical)	1 to 31.25 MHz: 125 kHz 31.5 to 100 MHz: 250 kHz 100.5 to 250 MHz: 500 kHz 251 to 500 MHz: 1 MHz 1 to 300 MHz: $20 - 12.5 \log(f/100)$, 20 dB maximum 300 to 500 MHz: 14 dB 90 dB
Characteristic impedance	Range: 45 Ω to 110 Ω Resolution: 1 Ω Accuracy: $\pm(5 \Omega + 5 \%$ of $ 75 \Omega - \text{Measured} $) Cable must be longer than 4 m for a measurement of characteristic impedance.
HDTDR	Range: 150 m (490 ft) Resolution: 0.1 m or 1 ft Accuracy: 0 m to 150 m (0 ft to 492 ft): $\pm(0.3 \text{ m} + 2 \%)$

Internal Memory for Test Results

You can save approximately 12,700 Cat 6A Autotest results, with plot data included, in the tester's internal memory.

The capacity available for test results depends on the space used by the software and custom test limits in the tester.

USB Flash Drive

You can upload test results to a USB flash drive to make more internal memory available.

Note

The tester reads only USB drives that use the FAT format.

Serial Interfaces

- USB host interface with a type A USB port: Lets you save test results on a USB flash drive and connect a Wi-Fi adapter for access to Fluke Networks cloud services such as LinkWare™ Live.
- USB interface with a Micro-AB USB port: Lets you connect to a PC to upload test results and update the tester's software.

RJ45 Connector on the Main Unit

Lets you connect to a network for access to Fluke Networks cloud services such as LinkWare™ Live.

Headset Jack

Connects to a stereo headset, 32 Ω , with microphone, 22 Ω , and 3.5 mm plug. See Figure 79.

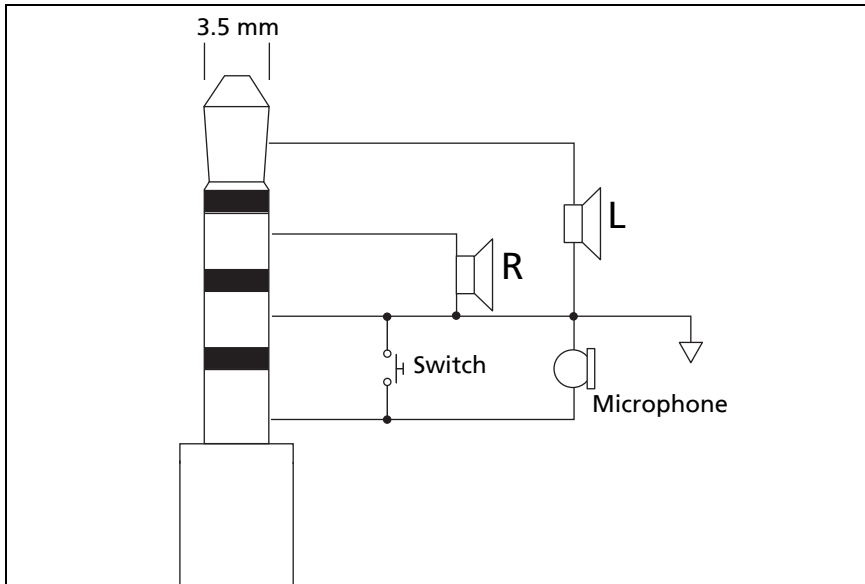

GPU194.EPS

Figure 79. Plug for the Headset Jack

Display

5.7 in LCD display with a projected capacitance touchscreen.

Weights

Main DSX-600 unit	2.98 lb (1.35 kg)
Remote DSX-600 units	2.42 lb (1.1 kg)

Dimensions

10.2 in x 5.2 in x 2.5 in (26.0 cm x 13.2 cm x 6.4 cm)

Index

Symbols

* in results, 58

% Tested

copper tests, 46

–1–

10 % rule, 65, 122

12 dB rule, 92

–3–

3 dB rule, 92

–4–

4 dB rule, 92

–6–

62 dB rule, 92

67 dB rule, 92

–7–

70 dB rule, 92

–A–

ac adapter, 16

AC wire map

setting, 52

test, 97

accessories, 200

ACR. See ACR-N.

ACR-F

causes of failures, 124

results, 86

ACR-N

causes of failures, 124

results, 82

alternate ID, 180

asset management feature, 179

asterisk in results, 58

attenuation. See insertion loss.

audible tone, 26

auto save, 39

automatic increment, 39

Autotest

asterisk in results, 58

coaxial, 107

coaxial settings, 105

count, 192

failures

twisted pair, 121

results

coaxial, 110

twisted pair, 58

twisted pair, 54

–B–

backlight timer, 25

bad patch cord, 57

battery

care, 197

charging, 16

removal, 197

status, 17

storage, 197

–C–

cable ID. See ID set.

- cable type
 - coaxial, 106
 - twisted pair, 50, 52
- calibration date, 192
- calibration dates, 191
- cautions, 4
- change test, 161
- channel connections, 57
- characteristic impedance
 - coaxial, 114
 - twisted pair, 78
- cleaning
 - case, 190
 - touchscreen, 190
- cloud services, 148, 172, 173
- coaxial
 - custom cable, 183
 - failures, 125
 - reference, 103
 - results, 110
 - settings, 105
 - splitters, 117
 - test, 107
 - tests without a remote, 117
- connector
 - bad connector on HDTDX plot, 136
- connectors on the tester, 8
- crossed pairs
 - ac wire map, 102
 - causes, 121
 - wire map, 63
- current series, 192
- cursor
 - copper test results plot, 72
 - HDTDR/HDTDX plots, 137
- custom copper cable type, 183
- custom outlet configuration, 186
- customer support, 2

–D–

- date, 24
- dB rules, 90
- decimal separator, 25
- default project, 41
- delay skew
 - causes of failures, 122, 125
 - results, 66
- diagnostic tab
 - coaxial results, 110
- display
 - brightness, 26
 - cleaning, 190
 - use the touchscreen, 19
- DSP-PMxx, 14
- DSX-PLA001, 14
- DSX-PLA004 replacement tip, 198

–E–

- ELFEXT. See ACR-F.
- End Not Found, 118
- error message, 200
- Ethernet connection for LinkWare Live, 174

–F–

- FAIL
 - coaxial test failures, 125
 - twisted pair test failures, 121
- FAIL*, 59
- FEXT, 86
- fix later, 37
- flash drive
 - projects, 171
 - results, 146
- flash drive for test results, 146
- Fluke Networks
 - contact, 2
 - Knowledge Base, 2

-G-

gold support, 2

-H-

HDTDR analyzer, 127

coaxial, 131

twisted pair, 128

HDTDR/HDTDx

setting, 51

tools menu, 127, 133

HDTDx analyzer, 133

help (contact Fluke Networks), 2

home screen

DSX CableAnalyzer, 43

-I-

i

twisted pair test results

dB rules, 90

resistance, 68

ID set

copy, 154

delete from a project, 154

delete imported ID set, 169

import, 169

invalid, 167

make an ID set, 40

maximum number of IDs, 166

next ID, 168

options, 38

setup screen, 158

troubleshooting, 167

impedance, 78

coaxial, 114

insertion loss

causes of failures, 123, 125

coaxial, 116

twisted pair, 74

IP address, 190

-K-

keyboard, 22

Knowledge Base, 2

-L-

language, 24

length

coaxial, 112

continuous test, 120

single test, 70

twisted pair

causes of failures, 122

results, 65

link interface adapters

about, 12

LinkWare Live

asset management feature, 179

software updates, 196

Wi-Fi connection, 175

wired connection, 174

LinkWare PC and LinkWare Stats, 29

-M-

MAC address, 174

MEASURE button

coaxial Autotest, 108

twisted pair Autotest, 55

memory

capacity, 27, 213

flash drive

projects, 171

results, 146

status, 27, 149

upload results to a PC, 147

view results, 141

-N-

N/A

in LinkWare PC results, 90

- twisted pair results
 - length, 66
 - LinkWare PC, 90

NEXT

- causes of failures, 124
- HDTDX analyzer, 133
- results, 79

- next ID, 168

- number format, 25

NVP

- coaxial setting, 106
- differences, 66, 112
- twisted pair setting, 50

—O—

open

- ac wire map, 101
- causes on twisted pair, 121
- HDTDR plot, 130
- wire map, 61

operator

- LinkWare Live ID (email address),
174, 175

- options and accessories, 200

- outlet configuration, 52
 - custom, 186

—P—

- parts, 200

- PASS*, 58

patch cord

- bad patch cord
 - message, 57
 - on HDTDR plot, 130
 - on HDTDX plot, 136

- performance tab, 64

permanent link

- adapters, 12

- permanent link connections, 56

- personality modules, 14

- plots (coaxial)

- store plot data, 106

plots (twisted pair)

- black limit line, 90
- description, 71
- store plot data, 51

PoE

- AC wire map setting, 52
- do tests through a PoE device, 97

- power-down timer, 25

project

- copy to another tester, 172
- flash drive, 171
- project screen, 152
- purpose, 151
- set up a project, 152

propagation delay

- causes of failures, 122, 125
- coaxial, 112
- results, 112
- twisted pair, 66

PS ACR-F

- causes of failures, 124
- results, 88

PS ACR-N

- causes of failures, 124
- results, 84

PS NEXT

- causes of failures, 124
- results, 81

- PSACR. See PS ACR-N.

- PSELFEXT. See PS ACR-F.

—R—

reference

- twisted pair, 48
- when to set
 - coaxial, 103
 - twisted pair, 48

remote tester

- battery status, 17
- version information, 190

- replacement parts, 200
- resistance
 - causes of failures, 122, 125
 - coaxial
 - continuous test, 120
 - results
 - coaxial, 113
 - twisted pair, 68
 - twisted pair
 - continuous test, 70
- results
 - delete, rename, move, 144
 - flash drive, 146
 - replace a saved result, 144
 - results screen, 142
 - table or plot, 70
 - upload to a flash drive, 146
 - upload to a PC, 147
- return loss
 - causes of failures, 124
 - HDTDR analyzer, 127
 - results, 76
- reversed pair
 - causes, 121
 - wire map, 63
- S-**
- safety information, 4
- self test, 189
- serial number, 191
- service, 200
- settings
 - coaxial, 105
 - twisted pair, 49
 - user preferences, 24
- shield test, 50
- short
 - ac wire map, 101
 - causes, 121
 - HDTDR plot, 130
 - wire map, 62
- single tests, 70
- software
 - update, 192
 - version, 190
- specifications
 - calibration, 213
 - certifications and compliance, 213
 - dimensions, 214
 - display, 214
 - DSX-CHA003 coaxial adapter, 212
 - environmental and regulatory, 203
 - headset jack, 213
 - memory, 213
 - power, 213
 - RJ45 connector, 213
 - serial interfaces, 213
 - weight, 214
- split pair
 - causes, 121
 - HDTDX plot, 136
 - wire map, 62
- splitters, 117
- storage, 197
- store plot data
 - coaxial, 106
 - twisted pair, 51
- sync projects screen, 178
- system log, 200
- T-**
- talk function, 95
- test limit
 - black limit line on plots, 90
 - coaxial setting, 106
 - twisted pair setting, 51
- test setup
 - copy, 154
 - delete, 154
- time, 24

tone generator, 94
touchscreen
 cleaning, 20
 use the touchscreen, 19
twisted pair
 See *also* Autotest
 custom cable, 183
 failures, 121
 reference, 48
 results, 58
 settings, 49
 test, 55
 tutorial, 31

wired Ethernet
 connection for LinkWare Live,
 174
 settings for LinkWare Live, 178

–U–

units for length measurements, 25
Unknown
 coaxial impedance test, 118

–V–

version information, 190

–W–

warnings
 maintenance, 189
 safety, 4
Wi-Fi
 connection for LinkWare Live,
 175
 delete settings and passwords,
 179
 settings for LinkWare Live, 179
wire map
 AC wire map
 results, 97
 setting, 52
 causes of failures, 121
 results, 60
 single test, 59