

PITE 3561 Power Quality Analyzer

User Manual

P-120907-V1.4

The logo for PITE, consisting of the letters 'PITE' in a bold, italicized, blue sans-serif font.

4/F, Bldg A, Chiwan Industrial Park, Shaodi Rd.,

Chiwan, Shekou Area, Shenzhen, China

TEL: +86-755-2680 5759

FAX: +86-755-2688 0310

www.pitotech.com

Catalogue

1. INTRODUCTION	3
1.1 Packing List.....	3
1.2 Safety Information.....	4
1.3 Operating Precautions	5
2. OVERVIEW.....	5
2.1 About PITE 3561	5
2.2 Functions	6
2.3 Features.....	6
2.4 Technical Parameters.....	7
2.5 Definition of Abbreviation	8
3. MEASUREMENT PREPARATION	9
3.1 Battery Charging	9
3.2 Cable Connection	9
3.3 Analyzer Power-on.....	10
4. MEASUREMENT	10
4.1 Volts/ Amps/ Hertz.....	11
4.2 Harmonics.....	12
4.3 Power & Energy	13
4.4 Unbalance.....	14
4.5 Record	14
4.6 Fluctuation/ Flicker.....	15
4.7 Dips/ Swells	16
4.8 Inrush.....	16
4.9 Scope.....	17
5. SYSTEM MANAGEMENT	18
5.1 Data Management	18
5.2 System Setting.....	19
5.2.1 Calibration.....	19
5.2.2 Parameter Setting.....	19
5.2.3 Date & Time	19
5.3 Language Setting.....	20
5.4 Voltage Color Setting	20
5.5 Phase Angle Setting.....	20
5.6 Firmware Version and Update.....	21
6. SERVICE AND MAINTENANCE	21
6.1 Maintenance	21
6.2 FAQ.....	22
7. PITE 3561 DATAVIEW SOFTWARE	22
7.1 Software Installation.....	22
7.2 Software Operation	23
8. ORDER INFORMATION	26

1. INTRODUCTION

This Users Manual gives full information on how to use PITE 3561 Power Quality Analyzer (hereinafter called “Analyzer”) safely and effectively. Please read the manual carefully so as to obtain maximum performance of the analyzer and its accessories.

IMPORTANT: Please read this manual completely before connecting and powering on the analyzer to avoid possible damage caused by improper use of this instrument.

1.1 Packing List

After receiving the analyzer, please check it carefully as below:

- Ensure that no damage occurred during transportation. Upon any damage or failure of operation based on this instrument, please contact your supplier immediately.
- Make sure you have each items below:

1) Main unit



All sides of PITE 3561 main unit:



Back



Side (with belt buckle)



Bottom (1 USB socket and 1 power socket)



Top (6 connecting sockets)

Fig. 1.1.1 PITE 3561 Main Unit

2) Accessories:

- ①. User Manual (this manual,1)
- ②. Power Adaptor (1)
- ③. Voltage Test Leads (5)
- ④. Standard Current Clamps* (3)
- ⑤. Alligator Clips (5)
- ⑥. USB drive (1)
- ⑦. Voltage Probes (2)



⑧. Carrying Case (1)

Sample picture of PITE 3561 accessories:



Fig.1.1.2

*Note:

- 1) About sample picture is just for your reference. Current clamps may differ as per different customers.
- 2) Standard PITE 3561 units will come with 3 current clamps. Optional current clamp below 100A for neutral will be available upon request.

1.2 Safety Information



For your protection, please read this safety information completely before operating the analyzer. Carefully observe all warnings, precautions and instructions.

Warning: Servicing described in this manual is to be done only by qualified service personnel. To avoid electrical shock, do not service the instrument unless you are qualified to do so.

 <p>DANGER</p>	<p>Safety tested has been done on this instrument thoroughly before shipment. However, mishandling during use could result in injury or death, as well as damage to the instrument. Make sure that you understand the instructions and precautions in the manual before use. We disclaim any responsibility for accidents or injuries not resulted directly from instrument defects.</p>
--	--

Safety Symbols:

The following symbols are used on the instrument and in this manual.

 DANGER	Indicates correct operation to prevent an extreme hazard that could result in serious injury or other bad consequences to users.
 WARNING	Indicates correct operation to prevent a significant hazard that could result in serious injury or other bad consequences to users.
 CAUTION	Indicates correct operation to prevent possible injury to users or damage to the instrument.
NOTE	Indicates advisory items related to performance or correct operation of the instrument.

1.3 Operating Precautions

To avoid electrical shock or fire, read these precautions first before using the analyzer:

- Avoid working alone.
- Do not operate the Analyzer around explosive gas or vapor.
- Use only insulated current probes, test leads and adapters as supplied with the Analyzer.
- Before use, inspect the Analyzer, voltage probes, test leads and accessories for mechanical damage and replace when damaged. Look for cracks or missing plastic. Pay special attention to the insulation surrounding the connectors.
- Remove all probes, test leads and accessories that are not in use.
- Always connect the Battery Charger / Power Adapter first to the AC outlet before connecting it to the Analyzer.
- Use the ground input only to ground the Analyzer and do not apply any voltage.
- Do not apply input voltages above the rating of the instrument.
- Do not apply voltages in excess of the marked ratings of the voltage probes or current clamps.
- Do not use exposed banana plug connectors.
- Do not insert metal objects into connectors.
- Use only the power supply, Model PITE 3561 (Battery Charger / Power Adapter).
- Before use, check that the selected/indicated voltage range on the PITE 3561 matches the local line power voltage and frequency.
- For the PITE 3561, use only AC line plug adapters or AC line cords that comply with local safety regulations.

2. OVERVIEW

2.1 About PITE 3561

The Analyzer offers extensive and powerful measurement to check power distribution systems. It provides measurement for harmonic, power & energy, unbalance, dips & swells, flicker and so on. Thus it gives a general analysis for system performance and specific details. Testing result could be read on the instrument directly and also uploaded

to a personal computer via a USB drive for further analysis.

2.2 Functions

PITE 3561 provides comprehensive functions for power quality analyzing as below:

Volts/Amps/Hertz

It gives a fast overview of Volts, Amps and Hertz. Use this function to get a first impression of the voltage and current signal before examining the signal in more details.

Harmonic

Use Harmonic mode to check voltage and current harmonics and THD per phase. It can check up to 50th harmonics. Trend of harmonics could also be recorded.

Power & Energy

It displays active power (W), apparent power (VA), reactive power (VAR) and power factor (PF) of balanced 3-phase, 3-wire power systems

Unbalance

Each phase voltage should not differ more than 1 % from the average of the three. Current unbalance should not exceed 10 %. Use Scope Phase or Unbalance mode to investigate unbalances.

Dips & Swells

Use Dips & Swells to record transient changes of voltage

Fluctuation & Flicker

Use Flicker testing to check short and long term voltage flicker and related data per phase.

Records

In this mode, you will find complete records of previous testing for voltage, current, frequency, power, power factor, total voltage harmonics distortion (THD), total current harmonics, and fluctuation & flicker results.

Scope

It shows voltage and current signal.

2.3 Features

- ◆ Portable design and colorful touch screen
- ◆ Applied to standard of EN 50160
- ◆ Could test 3-phase volt, null line volt, 3-phase current, null line current, etc.
- ◆ Up to 50 times harmonic testing with frequency spectrum graph
- ◆ Power testing: 3-phase apparent power, active power, reactive power, power factor, and 3-phase electric power.
- ◆ 3-phase unbalance testing with vivid chart
- ◆ Record at least 40 times of surge current
- ◆ Testing for wave motion, short-time flicker and long-time flicker
- ◆ Record up to 40 times of sag and swell
- ◆ Could have long-time record for basic (stable) power quality parameter. Recording time interval adjustable between 3 second and 30 minutes.
- ◆ Digital oscilloscope, checking waveform for voltage and current signal
- ◆ With PITE DataView software for convenient analyzing of testing result

2.4 Technical Parameters

LCD screen: 320 x240 TFT

Input Impedance: 1MΩ, 20pF

Measurement Range:10~700Vrms

Arms:1A,10A,100A,1000A and higher with relative current clamps)

Frequency 30Hz~80Hz

Harmonic Measurement: 0~50th harmonic

Inrush Current: 2000A

Peak Voltage: 1000V

Internal Memory: 128Mb

LCD Display: 320*240 pixel, touch screen

Communication Port: USB

Net weight: 7 kg

Other specifications:

Specifications	Range	Accuracy
Volt/Amp/ Hertz	Volt: 10~700V (true rms) Amps: 0.5~3000A (true rms, with relevant current clamp) N current: 0.5~25A (true rms) Current Peak: 0-3000A Volt Peak: 0-1000V Crest factor: 0-10 Hertz: 40~70Hz	Volts: ±0.5% Amps: ±0.5% Hertz: ±0.01Hz <u>NOTE:</u> Take frequency of L1 as total testing frequency.
Harmonic	Volts: total harmonic +1~50th Amps: total harmonic +1~50th k-factor: 0-10	Volts: ±0.1(%r) Amps: ±1% ±0.5%
Power testing	Active Power: 0.05~700KW Apparent Power: 0.05~700KVA Reactive Power: 0.05~700KVAR Power Factor: 0.00~1.00 Active Energy: 0.01~10000kWh Apparent Energy: 0.01~10000kVAh Reactive Energy: 0.01~10000kVARh Average Power Factor: 0.00~1.00	Active Power: ±1% Apparent Power: ±1% Reactive Power:±1% Power Factor: ±0.005 Active Energy: ±1% Apparent Energy: ±1% Reactive Energy: ±1%h Average Power Factor: ±0.005
Unbalance	Fundamental Volts: 10~700V (true rms) Fundamental Amps: 0.5~1000A (True rms) Fundamental Hertz: 40~70Hz Phase Angle:-180° -180° or 0~360° Unbalance: 0.0%~100%	Volts: ±0.5% Amps: ±0.5% Hertz: ±0.01Hz Phase Angle: ±0.3° Volt unbalance: ±0.2% <u>NOTE:</u> Take frequency of L1 as total testing

		frequency.
Data Recording	Recording for: 3 phase voltage, current, null current, voltage harmonic (THD and 1~25 harmonics), current harmonics (THD and 1~25 harmonics), unbalance, KW, KVA,KVAR, PF, flicker and fluctuation	Time interval: 3s~30min adjustable Time duration: <960 hours
Sags(Dips)/Swells	Volts sag, Volts Swells and instant interruption	Maximally could record 40 times
Fluctuation	Voltage Fluctuation:0.1%~10.0%	≤±5%
Flicker	Short-time and long-time flicker	Short-time: ≤±5%
Scope	3-phase Volts, 4-wire Current, null volt and null current waveform	Max Hertz: 200KHz Min Hertz: 100Hz

2.5 Definition of Abbreviation

Here is definition of all abbreviated words in PITE 3561main body menu:

Abbreviation	Full name	Where are they?
AVG	average	VOLTS/AMPS/HERTZ
Amp(s)	Current	VOLTS/AMPS/HERTZ, HARMONICS,etc.
VECT.	Vector graphic	VOLTS/AMPS/HERTZ, HARMONICS,etc.
DET.	Detailed	VOLTS/AMPS/HERTZ, HARMONICS,etc.
TRE.	Trend	VOLTS/AMPS/HERTZ, HARMONICS,etc.
HIST.	Histogram	HARMONICS
HAR.	harmonic	HARMONICS
PF	power factor	POWER & ENERGY
Ne.s.	Negative sequence	UNBALANCE
Po.s.	Positive sequence	UNBALANCE
Unbal.	Unbalance	UNBALANCE
Rec.	record	RECORD
V	Voltage	RECORD
Fluct.	Fluctuation	FLICKER
Pst	Short-term Flicker	FLICKER
Plt	Long-term Flicker	FLICKER
Thrs	threshold	DIPS/SWELLS
T	time	INRUSH

CH	channel	SCOPE
DEL.	delete	SYSTEM-DATA MANAGEMENT
TO USB	Save in USB drive	SYSTEM-DATA MANAGEMENT
CALI.	calibration	SYSTEM-SETTINGS
I	Current	SYSTEM-SETTINGS
PARA	parameter	SYSTEM-SETTINGS
PARAM	parameter	SYSTEM-SETTINGS
TP	touch panel	SYSTEM-SETTINGS
Rng	range	SYSTEM-SETTINGS
PT	potential transformer	SYSTEM-SETTINGS
CT	current transformer	SYSTEM-SETTINGS

3. MEASUREMENT PREPARATION

3.1 Battery Charging

Before measurement, make sure that the main unit has sufficient power. When the battery power gets low, please charge it timely.

PITE 3561 AC power adaptor which could be connected with main body for proper AC power supply. This is used when the Analyzer is working in the function of “Recording” which may take longer time online.

⚠️WARNING: To avoid electric shock, please always connect the battery charger/power adapter to the AC outlet before connecting it to the Analyzer.

3.2 Cable Connection

Before measurement, please connect the voltage testing leads with analyzer. Then select necessary voltage test probes and current clamps. Make sure that the probes, clamps and measured conducting wires are correctly connected like instruction below (Fig. 3.2.1 and Fig. 3.2.2). Try to get the tested leads vertically pass through the clamp holes as below. Colors of voltage testing sockets for L1, L2, L3 and Neutral and Ground will be all in black with color labels nearby for different countries standards. Voltage testing leads are all labeled in colors accordingly at both ends of the lead. Please connect the leads correctly (e.g. Fig. 3.2.3).

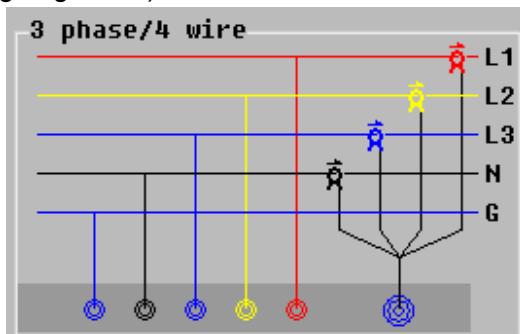

Fig. 3.2.1

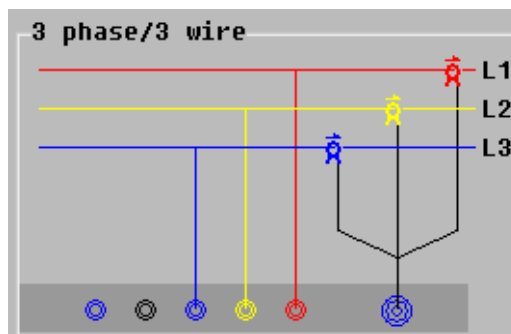

Fig. 3.2.2



Fig. 3.2.3

PITE 3561 only have connections for 3 phase/3 wire and 3 phase/4 wire. Before the measurement, please firstly do system setting. For detailed instruction, please refer to **5.2.2 Parameter Setting**. If you need to test single phase, please select 3 phase/4 wire and connect voltage and current signal to relevant position of L1.

⚠ DANGER: To avoid electric shock and short-circuit, please carefully connect the testing probes with the testing sources.

3.3 Analyzer Power-on

Press the red power button on main unit to turn on the analyzer. Screen of main menu will be displayed as below upon power-on.

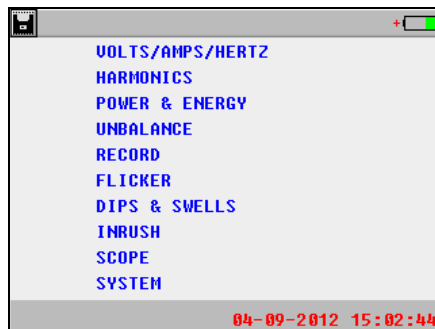



Fig. 3.3

Battery icon  on the right top indicates the power status of battery. If it is low, please charge it timely.

The icon  on the left top is for screenshot. To save the current screen, please firstly connect the USB drive. To avoid mis-operation, please click the icon to highlight it and press again for screenshot.

“04-09-2012 15:02:44”: This is the system time. For time and its format setting, please refer to **5.2.3 Date & Time**.

NOTE: The screen will automatically become dark for power saving when it is idle for 1 minute. To restart it, please click anywhere on the screen.

4. MEASUREMENT

In this detailed description for PITE 3561 measurement functions, three phase color will be exemplified as L1(Red), L2(Yellow), L3(Blue) and Neutral (Black). The color code will

be different depending different countries or districts. For detailed color setting, please refer to **5.4 Voltage Color Setting**.

4.1 Volts/ Amps/ Hertz

It measures fundamental parameters including voltage, current and frequency for all phases and Neutral. Detailed information is displayed with trending and waveform.

To start testing, click “VOLTS/AMPS/HERTZ” on the main menu. And you will come to the following screen. It presents 3-phase voltage, 3-phase current, Neutral current and L1 frequency as below.

For voltage, it is value for phase-neutral in 3 phase 4 wire. And in 3 phase 3 wire, it is value for phase-phase.

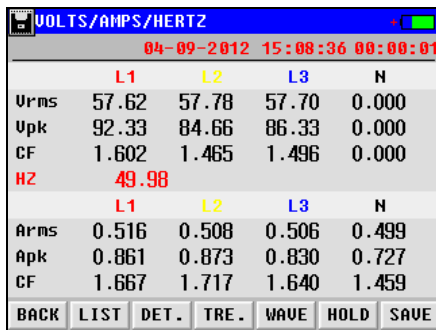

Fig. 4.1.1 List

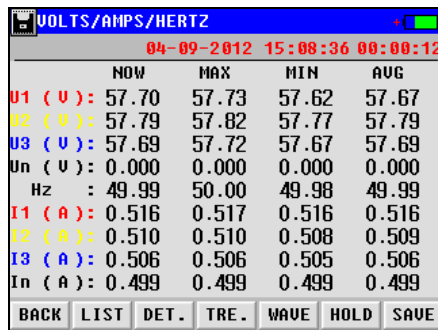

Fig. 4.1.2 Detail

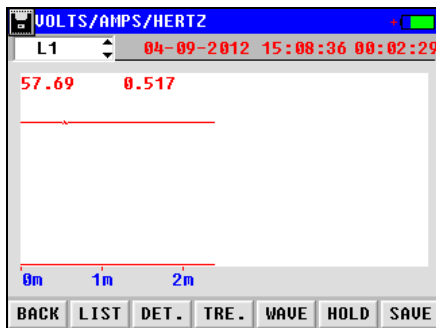

Fig. 4.1.3 Trend

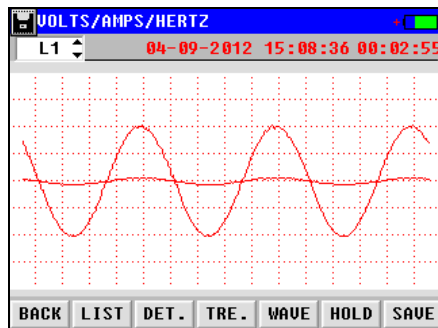

Fig. 4.1.4 Wave

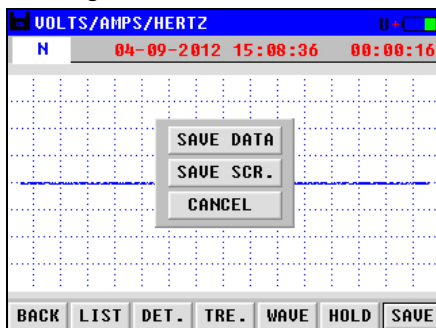

Fig. 4.1.5 Save

Descriptions of the buttons on the screen are as below:

BACK: Click it to go back to the upper menu.

LIST: Listing for Voltage (rms, peak value and crest factor), current (rms, peak value and

crest factor) and frequency (Fig. 4.1.1).

DET.: It presents detailed testing data for 3 phase and N including present, maximum, minimum and average data (Fig. 4.1.2).

TRE.: It displays the trending for voltage, current and frequency for each phase. Click the left top box to change the displaying data.

WAVE: It shows the waveform of each phase for voltage and current (Fig. 4.1.4).

HOLD: Click this button to read the measurement results and save them. To restart, click the other buttons, like **LIST.**

SAVE: Click to save the testing data or current screen. For screenshot, the USB drive should be connected (Fig. 4.1.5).

“04-09-2012 15:08:36”: It indicates the present time.

“00:00:16” indicates the duration of this measurement.

NOTE: Manually saving of testing data is important for all measurements except “Record” function which will automatically save the data.

4.2 Harmonics

Harmonics can be a huge hazard in electrical system, especially old ones. Test of harmonics is very important. This device tests THD and harmonic voltage and harmonic current for all phases with trend and spectrum (histogram). For comparison of testing value with international standards like EN 50160, please refer to **7. PITE 3561 DATAVIEW SOFTWARE.**

To get started in screen, click “HARMONICS” in main menu. Wait for 10 seconds. You will come to the list of testing data in Fig.4.2.1.

It measures harmonic voltage and current for all phases.

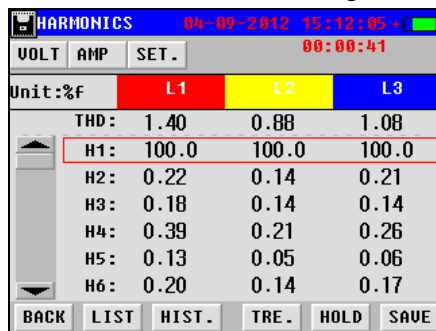

Fig.4.2.1 List

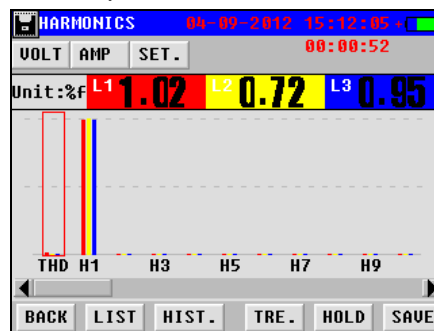

Fig.4.2.2 Histogram

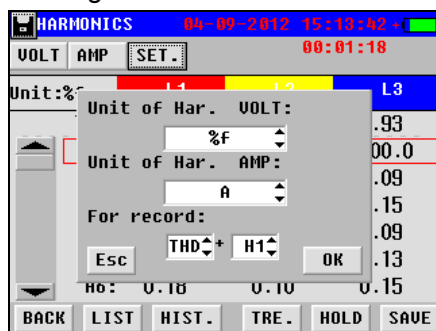

Fig.4.2.3 Setting

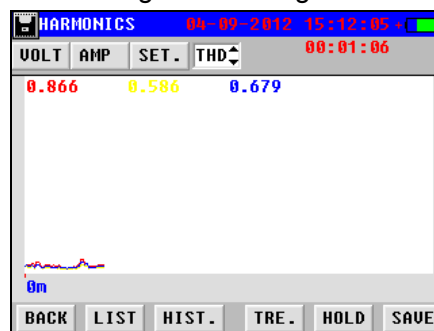

Fig.4.2.4 Trend

Below are the detailed descriptions of all the functions in Harmonic measurement:

Function keys of **Back**, **LIST**, **HIST**, **HOLD** and **SAVE** have the same operation as described in 4.1 Volts/ Amps/ Hertz.

SET.: It is setting for displaying units of voltage and current like Fig.4.2.3. When you click the button **VOLT** or **AMP**, you will see the presetting unit. Under “For record”, you could select any two harmonics that will display in **TRE.** (Selectable in Fig.4.2.4).

TRE.: It presents the trending for measuring data. Click the top center; you could switch between the two presetting harmonics (Fig.4.2.4).

4.3 Power & Energy

This is for testing both Power and Energy. They include the functions as below:

Power: 3-phase apparent power (kVA), active power (kW), reactive power (kVAR), power factor (PF), voltage (V), current (A) and phase angle.

Energy: 3-phase apparent energy (kVAh), active energy (kWh), reactive energy (kVARh), power factor, kVAh, kWh and kVARh.

In energy testing, the analyzer measures power consumption by integrated power measurement over time. You could use this function for quick verification of revenue meters.

To get started, click “POWER & ENERGY” in main menu and wait for 5 seconds, you will come to the screen below:

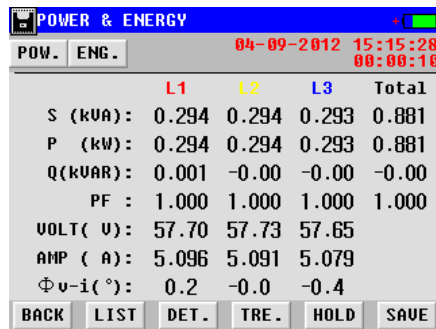

Fig.4.3.1 List

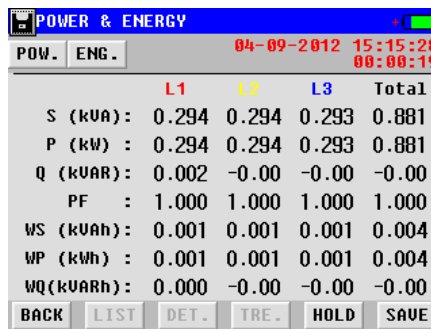

Fig.4.3.2 Energy

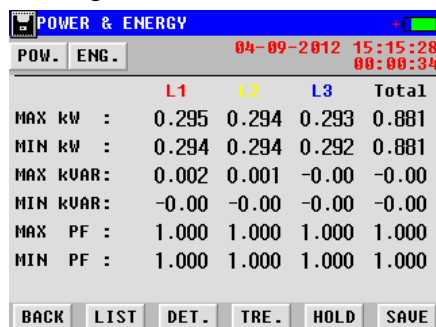

Fig.4.3.3 Detail (Power)

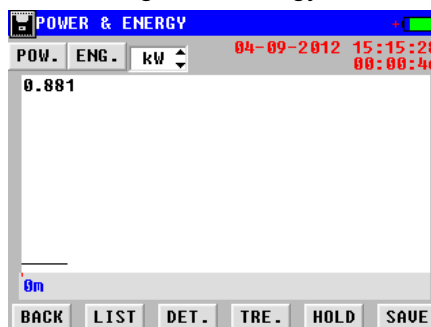

Fig.4.3.4 Trend

Click **POW** and **ENG** on the left top to switch between power testing and energy testing.

Operations of all the buttons are same as described before.

In Power testing, you could view the trending of active power (kW) and power factor (PF)

by Clicking the button **TRE.** These two items could be switched to each other in the option box on the top (Fig.4.3.4).

4.4 Unbalance

Unbalance is expressed as the ratio of negative sequence and null sequence to positive sequence components. A perfect balanced system has no negative sequence or null sequence components.

Before testing measurement of unbalance, you could alternatively set initial angle and angle range of different way. For instruction, please refer to **5.5 Phase Angle Setting**.

Unbalance measurement will test 3-phase unbalance for both voltage and current. Click **UNBALANCE** in the main menu and wait for 5 seconds to start testing as Fig 4.4.1. It presents the 3-phase unbalance in negative sequence (“Ne.s.”), positive sequence (“Po.s.”) and zero sequence (“Nu.s.”).

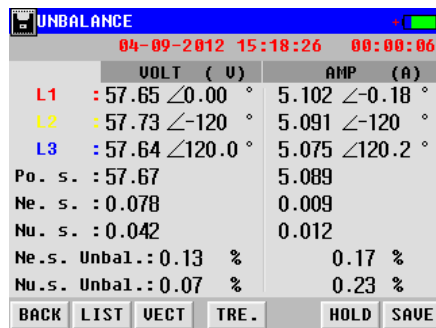

Fig 4.4.1

The data could also be viewed in vector when you click the button **VECT** and click **TRE** to view the tendency of measurement data. It will track the changes of unbalance as different loads come on and off line.

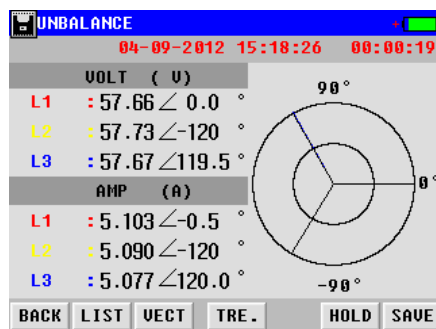

Fig. 4.4.2 Vector

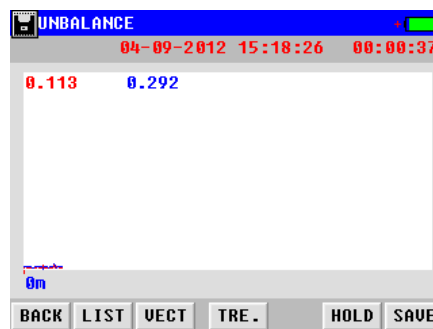

Fig. 4.4.3 Trending

4.5 Record

In the function “**RECORD**”, PITE 3561 will become a monitor for the testing functions of Voltage/current/frequency, Power, Harmonics, Unbalance and Flicker simultaneously. This function will help you uncover some hard-to-find or intermittent issues by recording all the testing data. Maximally PITE 3561 can record up to 960 hours with interval of more than 2 minutes and 59 seconds. It will capture shorter time duration with recording interval as low as 3 second.

Click "RECORD" in the main menu you will come to the next screen for parameter setting as below:

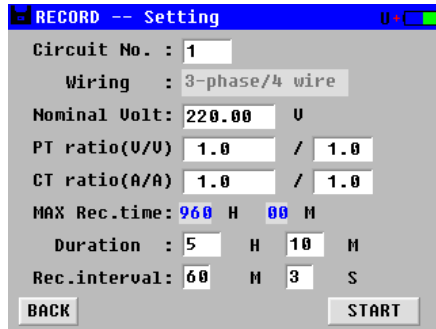

Fig. 4.5.1

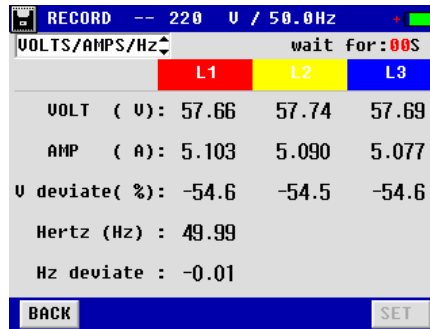

Fig. 4.5.2

Firstly do all the parameter settings. To change the way of wiring, please refer to **5.2.2 Parameter Setting**. As recording interval changes, maximum recording time will automatically be calculated.

After the setting, click **START** to proceed with recording measurement. The testing record will be automatically saved in main unit memory. To view this information, please refer to **5.1 Data Management**. Screen will display live data simultaneously for all functions. Click on the left top box to shift to other events like harmonics, flicker and so on.

NOTE: To ensure sufficient power supply during data recording, you are suggested to connect the Analyzer with proper AC source with power adaptor.

4.6 Fluctuation/ Flicker

Flicker measurement gives an indication of whether voltage fluctuations will cause annoyance for a typical person working under incandescent lighting (60W). A reading higher than 1 means most people will perceive the voltage changes. The testing is optimized on a incandescent lighting powered by 120V/50Hz or 230V/60Hz. Short-term flicker (Pst) and long-term flicker (Plt) for each phase will be displayed.

Voltage fluctuation is defined as a series of high-speed variation or continuous change of voltage rms. variation cycle is more than power frequency cycle. In power system, voltage fluctuation could happen many times. Variation process could be regular or irregular. Voltage fluctuation is normally described as relative voltage fluctuation. It is numbered as the ratio of two nearby extremums (keep changing in series of voltage rms) difference to rated voltage.

Click "FLICKER" in the main menu, input the rated voltage and wait for 6 seconds, you will see the screen as below (Fig. 4.6.2). If there is any event, it will be displayed on the screen.

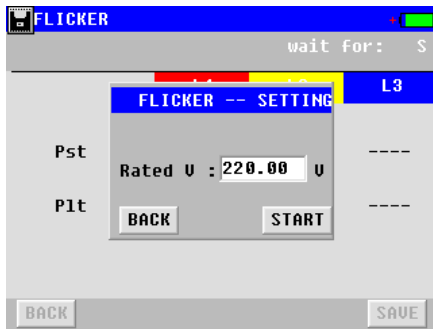

Fig. 4.6.1

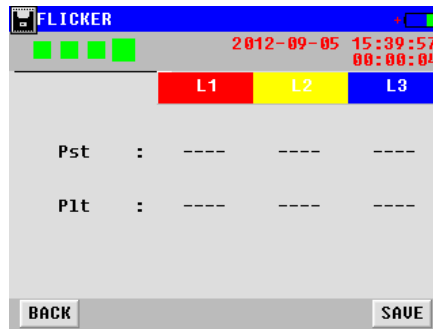

Fig. 4.6.2

4.7 Dips/ Swells

Dips & Swells are used to record transient changes of voltage as short as half a cycle. When the rms voltage exceeds the nominal voltage by 10 to 80% for 0.5 cycle to 1 minute, the event is called a "swell".

A "dip" (in British English) or a "sag" (in American English - the two terms are equivalent) is the opposite situation: the rms voltage is below the nominal voltage by 10 to 90% for 0.5 cycle to 1 minute.

Dips & Swells mode makes rapid rms voltage and current readings on all phases. To begin the test, click "Dips & Swells" for parameter settings.

Input the nominal voltage, swell threshold and dip threshold, and click **START** to carry out the test. You will see the waveform in Fig 4.7.2. In this screen, nominal voltage is defined as 100%. For example, if nominal voltage is 220V, then 264V will be described as 20% upper. 176V will be described as 20% lower.

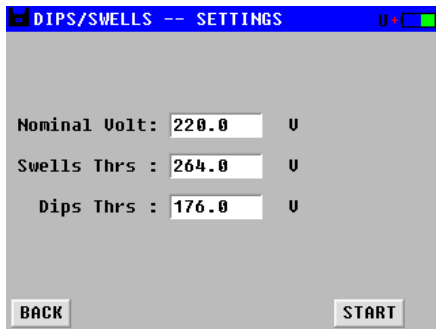

Fig 4.7.1

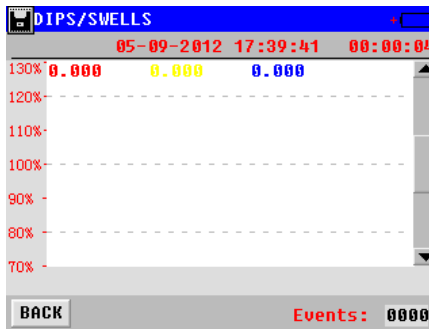

Fig 4.7.2

4.8 Inrush

Inrush is the dash current happens when there is high load or low impedance load. Generally, when the load is in normal working condition, current will be stabilized after some time, like the duration after some big loads (e.g. motor and frequency converter) starts.

Inrush testing function could record the variation trend from dash current to current stabilization. This process is called one inrush.

Click "INRUSH" in main menu, you will come to the screen for parameter setting as Fig 4.8.1.

“Expected T” indicates the expected time for testing inrush.

“Max Amp” indicates the maximal current that expected inrush may reach.

“Nominal Amp” indicates the current value of device under normal working condition.

“Threshold”: it is called one inrush when current value reaches the presetting threshold.

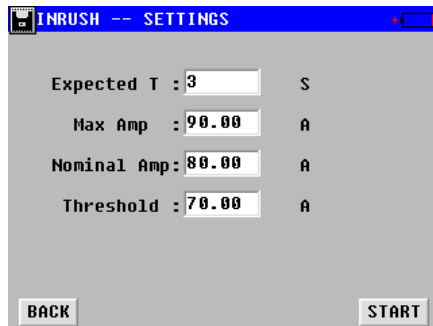

Fig 4.8.1

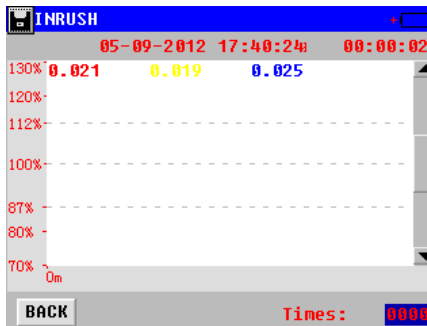

Fig 4.8.2

Nominal current is used as standard (100%), if current value reaches threshold, it is called one event. If nominal current is 20A, threshold is set as 30A. 30A is at 150%.

“Max Amp” is the maximal current that can be displayed during testing of inrush.

For exact time when inrush happens, users can refer to PC software of PITE 3561.

After the parameter setting, click the button **START** to begin the test Fig 4.8.2.

PITE 3561 will automatically keep record when inrush is detected. To manually quit the testing, please click the button **BACK**.

4.9 Scope

Oscilloscope function in PITE 3561 could simultaneously testing 3 phase 4 wire power system for voltage and current. It is used to observe and capture signal variation when power system is running. Click “SCOPE” in main menu, you will see the screen as Fig 4.9.1.

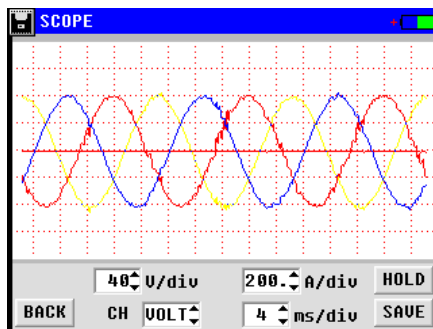

Fig 4.9.1

For the setting of displayed parameter, please click the options at the bottom of the screen to view the scope in different way.

“CH” indicates channel. It has options including voltage, current, L1, L2, L3 and N.

“div” indicates each lattice where the scope is described. Voltage has the range from 20V/div to 300V/div. Current has the range from 0.25 A to 2.5 A. time ranges from 1ms/div to 80ms/div.

To quit the scope testing, press the button **HOLD** and it will be change to **RUN**. To restart, click **RUN**.

5. SYSTEM MANAGEMENT

System setting includes function for data management, parameter setting, calibration, time setting and so on. For full information and operation, please click “**SYSTEM**” on main menu.

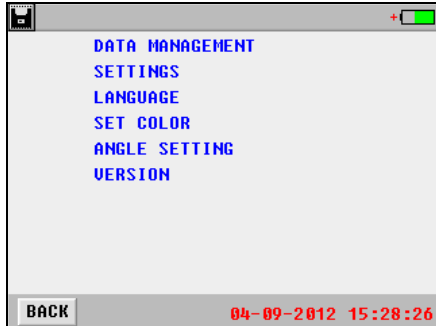

Fig 5

5.1 Data Management

All testing data you have saved before could be viewed, transferred to PC or deleted directly in data management. Screen with detailed information will be displayed as below by going to “SYSTEM”→”DATA MANAGEMENT”.

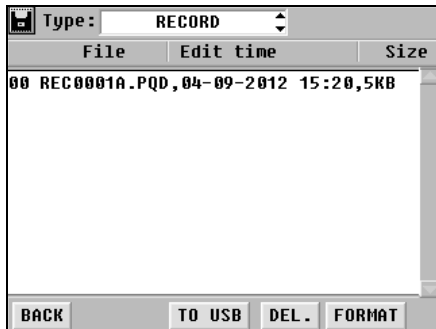

Fig 5.1

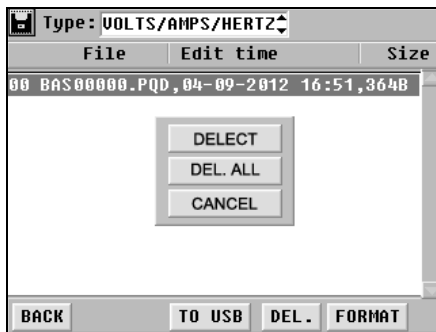

Fig 5.1.1

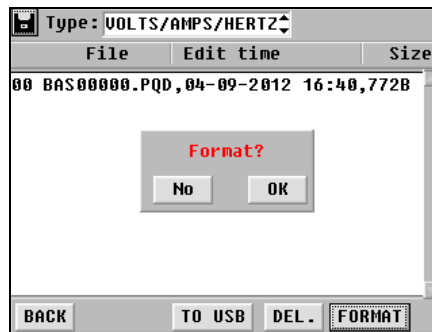

Fig 5.1.2

To save the data in your PC for analyzing, insert the USB drive properly, select the data and click **TO USB**. To delete the data, select the target and click **DEL.**. To format all testing data, click **FORMAT** directly. Warning screens will pop up as Fig 5.1.1 and Fig 5.1.2. Click **No** to exit or **OK** to confirm the operation. Please note that you have saved the data properly. Once deleted or formatted, they could not be recovered.

5.2 System Setting

5.2.1 Calibration

This is for calibrating the parameter of PITE 3561. All data have been well calibrated in PITE factory before the product is sent our customers. For testing accuracy, you are not suggested to carry out this operation if unnecessary. If you really need it, please contact your supplier or PITE for separate instruction.

5.2.2 Parameter Setting

Parameter setting is required before your testing, mainly described in 4. MEASUREMENT.

Please go to “PARAM SETTING” under menu “SETTINGS”. Screen will be as below:

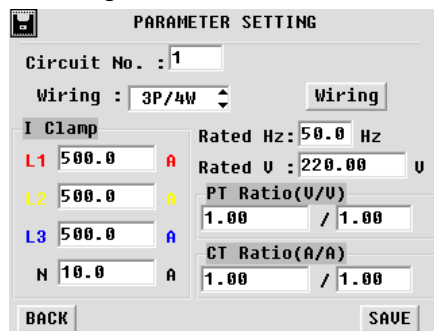

Fig. 5.2.2.1

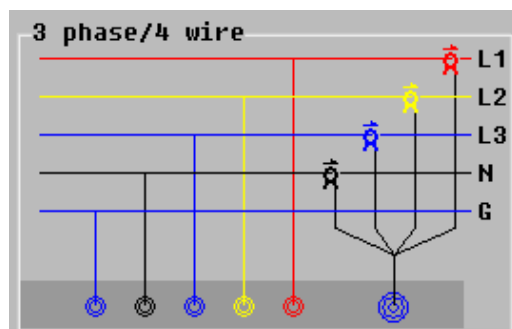

Fig. 5.2.2.2

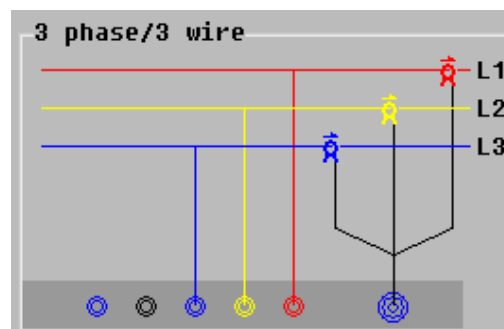

Fig. 5.2.2.3

“Circuit No.” indicates the serial number of circuit. This number is self-defined. You will view this number after you have saved the testing data and transfer to PC.

“Wiring” has two ways, 3 phase/4 wire and 3 phase/3 wire. Select either way and click the button **Wiring** to view connecting instruction as Fig. 5.2.2.2 and Fig. 5.2.2.3.

“I clamp” means current clamp. It is unique and customized for each configuration.

Other parameters like rated Hz and Rated voltage should be input accordingly based on concrete situation.

After all settings, please click the button **SAVE** and it will automatically go to upper menu.

5.2.3 Date & Time

For system time setting, please follow the route “SYSTEM”→“SETTINGS”→“DATA & TIME”. Click each option for date, time and format setting. After setting, click **OK** to save

the change.

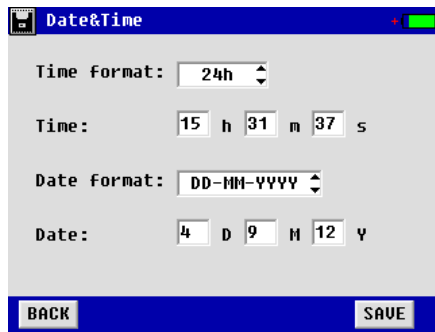

Fig. 5.2.3

5.3 Language Setting

Click “LANGUAGE” under the menu “SYSTEM” and select the language needed in the following screen:



Fig. 5.3

5.4 Voltage Color Setting

For standards of three phase voltage color code in different countries, PITE provide customized setting to be in accordance with the voltage testing lead. For its setting, please go to “SET COLOR” under the menu “SYSTEM”, you will see the screen below for setting color of L1, L2, L3 and Neutral.

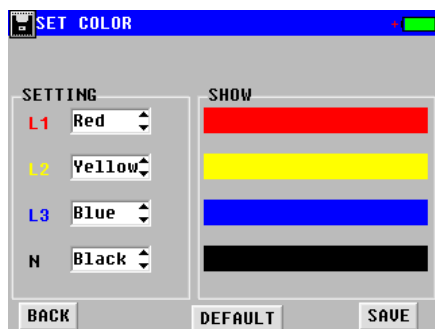

Fig. 5.4

5.5 Phase Angle Setting

This will enable you to set different way of display for phase angle in three phase unbalance. Please go to “ANGLE SETTING” under menu “SYSTEM”. You will see the

screen as below for initial angle setting and angle range (optional for -180° -180° and $0\sim360^{\circ}$).

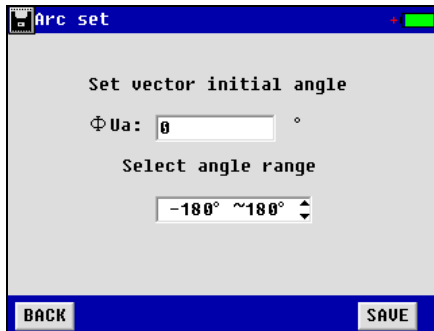
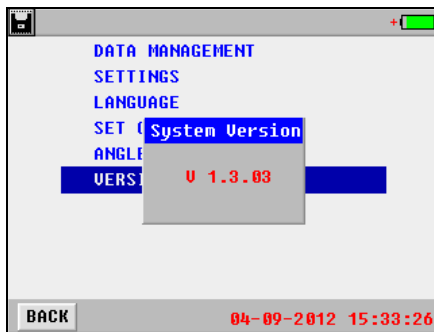

Fig. 5.5

5.6 Firmware Version and Update

Click “VERSION” under menu “SYSTEM”, you will see the firmware version.



Firmware Update:

PITE constantly updates its program as per customers’ need. To update the unit, please follow the steps as below:

- 1) Copy the two files (named “Program.hex” and “SCRIPT00.txt”) from PITE to the root directory of PITE USB drive.
- 2) Connect the USB drive with PITE 3561 main body and restart the unit.
- 3) Firmware update will be done in around one minute.

6. SERVICE AND MAINTENANCE

6.1 Maintenance

1). Cleaning

Clean PITE 3561 main unit and its accessories (current clamps, voltage probes, etc.) with a damp cloth and a mild soap. Do not use abrasives, solvents, or alcohol, as they can deform or discolor the analyzer and the accessories.

2). Storage

Place the PITE 3561 and all its accessories into the case after using. It is unnecessary to remove the battery pack even storing it for a long time. However, the battery will discharge itself gradually overtime. So please charge the batteries periodically (like once a month) to

keep them in optimal condition.

3). Battery Maintenance

3.1). Charging the Batteries

Connect the battery charger to the power supply then to PITE 3561 main unit. After the battery is full charged, it will automatically enter overcharge protection. No damage will occur to the analyzer even if you charge the batteries overtime.

3.2). Extending the Battery Life

To obtain optimized performance of the battery, discharge the battery completely and then recharge it fully.

6.2 FAQ

Below are the frequent asked questions that you might come across when using PITE 3561:

Q: The PITE 3561 can not start up. What is going wrong?

A: The batteries may be power off. If so, charge it properly.

Q: The Analyzer keeps beeping when it's on.

A: Power of battery is low. Charge it for a while and try again.

Q: The Analyzer is power off suddenly during testing.

A1: The battery may be out of condition. Replace it with a new one and try again.

A2: The testing leads may be well connected. Unplug the testing leads and plug again.

7. PITE 3561 DATAVIEW SOFTWARE

7.1 Software Installation

Double-click the software name like “PowerQualityAnalysisSystem v5.31 Setup.exe” in the PITE USB drive to start installation of the software. Click “Next”→select “I agree to the terms of this license agreement”→ Click “Next”→Change installation path if necessary→Click “Finish” to complete the software installation. Below screenshots are for your reference:

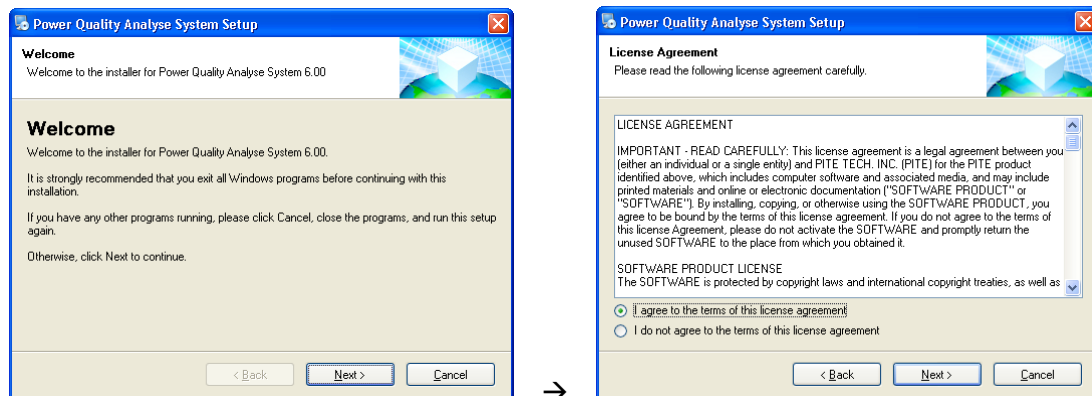

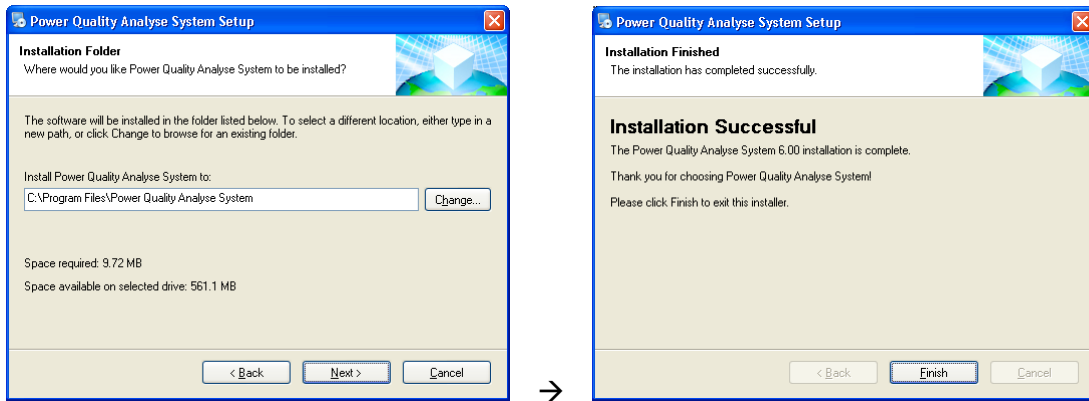

Fig 7.1.1

7.2 Software Operation

After installation is finished, click the icon named “Power Quality Analyse System” on computer desktop to run the software. You will see the main screen as below:

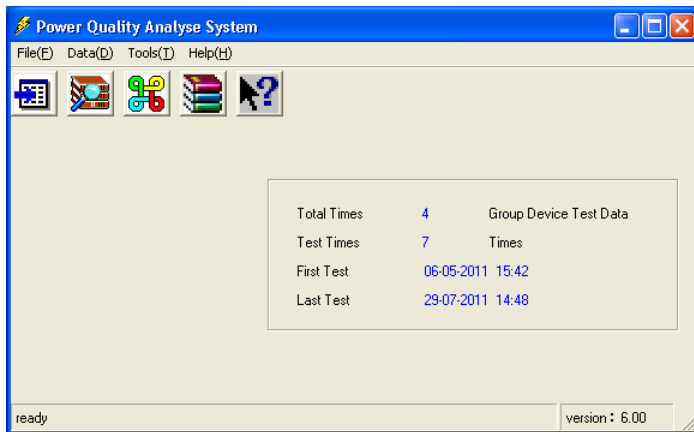

Fig. 7.2.1

It has 5 shortcut icons on the menu, when you move the mouse icon on each of them, their functions will display as: Import data, View data, Circuit info, Zip database, Version info. You could also refer to the menu directly.



Fig. 7.2.2

Input circuit information

This is to build up a database for all testing data that will be distinguished in different groups based on company name, size name and so on.

To do this, please go to the menu “File” and then “Input circuit info”, you will see the screen as below:

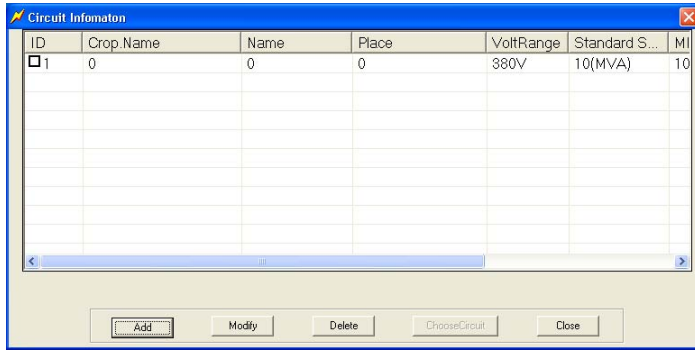

Fig. 7.2.3

Go to menu “File”—“Input circuit info”—select ID number—Click “Modify”, you will see the different setting for standards in the screen below:

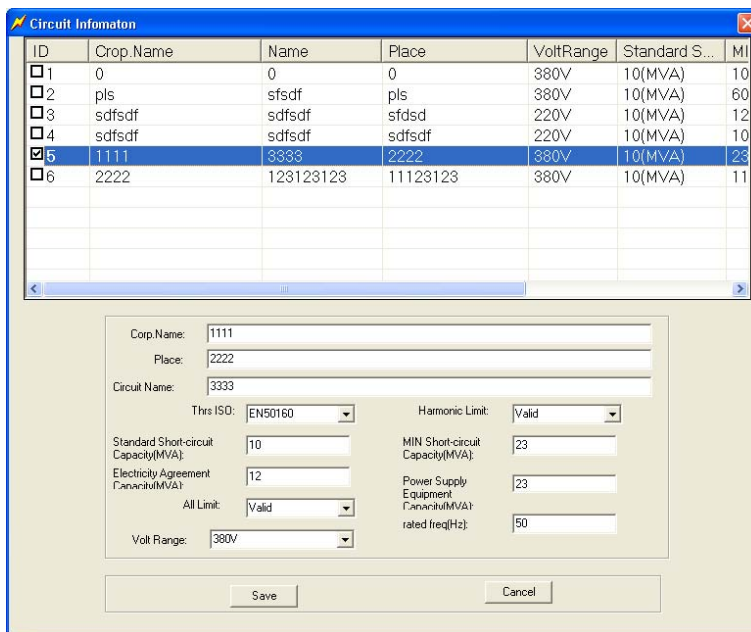

Fig. 7.2.4

“Thrs ISO” means threshold standard for different countries for comparison of harmonics. It could be EN 50160, Chinese standard or user defined standard. Then these value limits will be selected as “Valid” and information like “Standard short-circuit capacity” will be compared with testing result of harmonics to judge if the testing result has any problem in the local standard.

If this standard or limit is meaningless to you, you just set is “Invalid” in “Harmonic limit” and “All Limit”.

To add circuit information, please click the button “Add” in Fig. 7.2.3. Other operation is same as above.

User-defined voltage range

If above voltage range does not meet your local requirement, you could set this information by yourself. Please go to menu “Tools”→”System set”. You will come to the screen as below:

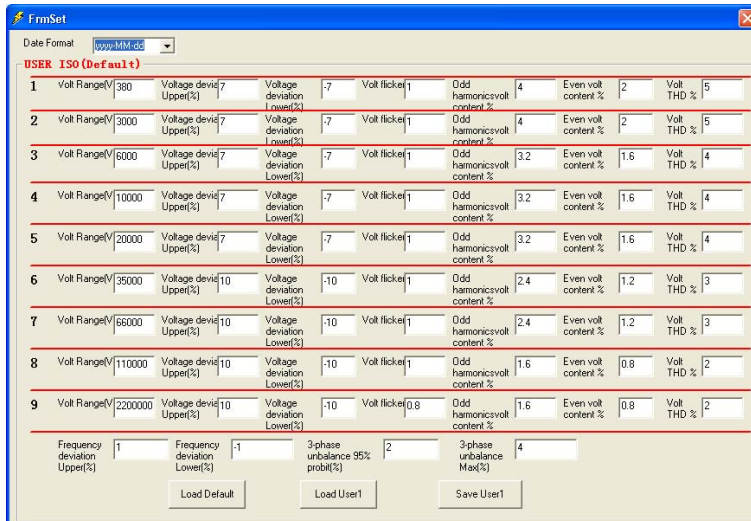

Fig. 7.2.5

You could set the voltage ranges and their relevant standards. After the setting, please click the button “Save user1”. Then you will have user defined data and default data.

Import testing data:

To import data, please go to menu “File”→”Import data”→Click “Yes”→select ID number as below and click “ChooseCircuit”→Select the testing data to import.

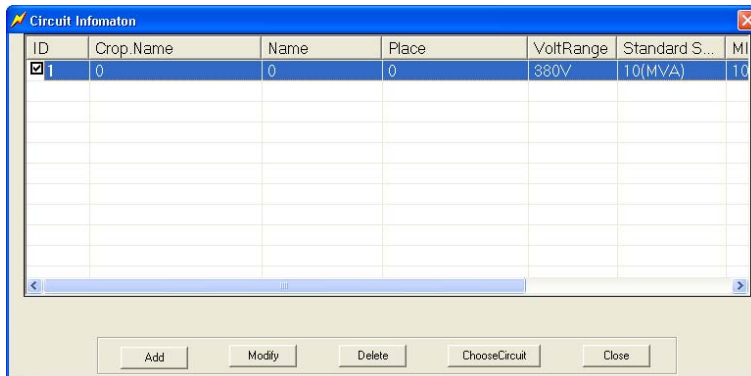
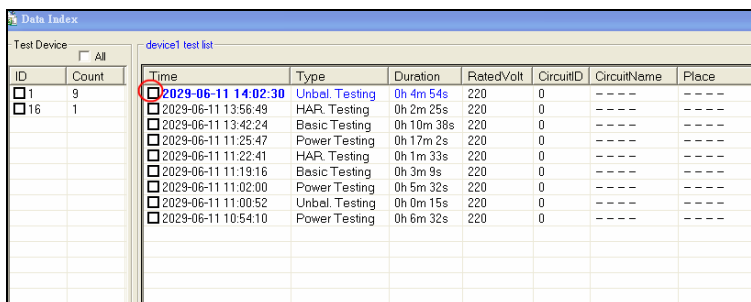

Fig. 7.2.6

View All Testing Data

To view data, please choose “Data”---“All data”, and then you will get a chart as below. You could also select data based on relevant testing function (e.g. Harmonics) under “Data” to view them individually. Double click relevant testing record; you will see detailed testing data exemplified as below.



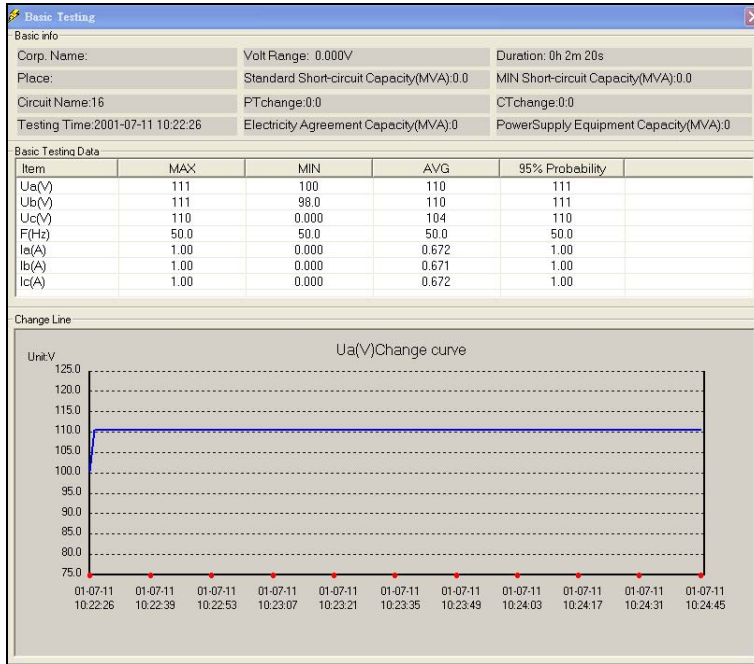

Fig. 7.2.7

To export the testing data to a report in Excel format, please choose the button "Export" like below (Fig. 7.2.8) and testing report will be exported in the format of Microsoft Excel.



Fig. 7.2.8

8. ORDER INFORMATION

PITE TECH. INC.

4/F, Bldg A, Chiwan Industrial Park, Shaodi Rd., Chiwan, Shekou Area, Shenzhen, China.

TEL: +86-755-2680 5759

FAX: +86-755-2688 0310

sales@pitetech.com

www.pitetech.com