

Product catalogue 2024

Product catalogue

PASSION FOR PERFECTION



Dipl.-Ing. H. Horstmann GmbH
Humboldtstraße 2 - 10
42579 Heiligenhaus
Germany

T +49 2056 976 0

info@horstmanngbh.com
www.horstmanngbh.com

All rights reserved to make technical changes.
101101-0000/1000/0924









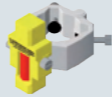

**Short-circuit and
earth fault indicators**

Remote monitoring

**Voltage detectors
and detecting systems**







Earthing devices













Substation accessories











About us		
	Company profile	8
Short-circuit and earth fault indicators		
	General information	9
	Product matrix Short-circuit indicators	10
	Product matrix Earth fault indicators	11
	Product matrix Short-circuit indicators and Earth fault indicators	12-13
	Product matrix Fault direction indicators	14-15
Mechanical indicators		
	Rotor indicator	16
	Fluid indicator	17
Short-circuit indicators		
	Opto F 3.0	18-19
	Sigma 2.0	20-21
	Alpha M Alpha E	22
Earth fault indicators		
	Earth 4.0	23
	Earth Zero Earth Zero Flag	24-25
Short-circuit and earth fault indicators		
	Opto F+E 3.0	26-27
	Sigma F+E 2.0 Sigma F+E 3 2.0	28-29
	Sigma L Sigma F+E L Sigma F+E 3 L	30-31
	ComPass A	32-33
	ComPass A 2.0	34-35

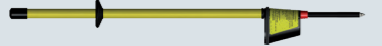



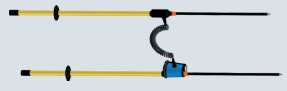
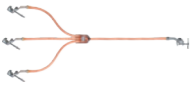





The contents, performance characteristics and diagrams listed in this catalogue are not always applicable in the form described in the specific application or may change due to further developments of the products. The textual content and illustrations have been processed with the greatest care. Nevertheless, errors cannot be completely excluded. The desired performance characteristics are only binding if they are expressly agreed upon when the contract is concluded. Delivery possibilities and technical changes reserved.

The names, trade names and descriptions of goods etc. given in this catalogue are subject to the guidelines of the respective manufacturer. Dipl.-Ing. H. Horstmann GmbH does not assume any obligation to keep this catalogue up to date.

Directional fault indicators		
	Device options / System composition	36
	Project planning	37
	Sigma D Sigma D+ Sigma D++	38-39
	Sigma DM	40-41
	ComPass B	42-43
	ComPass B 2.0 ComPass Bs 2.0	44-45
	ComPass D	46-47
Accessories		
	Phase current transformers	48-49
	Single-phase current sensors	50
	Summation current transformers	51
	Summation current sensors	51
	Product matrix Capacitive and resistive voltage signal	52-53
	Voltage sensors	54-56
	Accessories	58 - 59
Special indicators		
	Application (low-voltage monitoring)	60-61
	Trip Flag	62
Overhead faulted circuit indicators		
	Product matrix Overhead faulted circuit indicator	63
	Navigator LM Navigator LM HV	64-65
	Navigator LED+Flag	66-67
	Smart Navigator 2.0 Smart Navigator 2.0 HV	68-69

	Accessories	70
Remote monitoring		
	General information	71
	iHost	72-75
	Reporter 3.0	76 - 77
	Reporter 4.0	78 - 79
	Product matrix Remote monitoring	80
Voltage detectors and voltage detecting systems		
	General information	82
Integrated voltage detecting systems		
	Product matrix Integrated voltage detecting systems (VDIS)	83
	Wega 1	84 - 85
	Wega 1 V	86 - 87
	Wega 2	88 - 89
	Wega 2 V	90 - 91
	Wega 1 LV	92
	Wega T1	93
Voltage detecting and voltage indication systems		
	Orion 3.1 Orion M1	94 - 95
	HR-ST LRM-ST	96

Voltage detectors		
	Product matrix Voltage detectors Phase comparators	98 - 99
	FL-I	100
	Comet BL-I Comet BL-A	101
	Comet BK-I Comet BK-A	102
	Comet BS-I Comet BS-A	103
	BO-A 2.0	104 - 105
	BO-A AC/DC	106- 107
Phase comparators		
	Compare 2.0	108
	PG II	109
	Accessories	110
	Maintenance test	111
Earthing devices and accessories		
	General information	112 - 113
Earthing and short-circuiting devices		
	Three-phase device with ball tongs	114
	Three-phase device with universal compact clamp or universal line clamp	115
	Single-phase device without connection elements	116
	Short-circuiting bars	117

Connection points and clamps		
	Line connection points	118
	Line clamps	119
	Earth connection points	120
	Earth clamps Earth connecting elements	121 - 122
Devices for installations		
	Earthing sticks	123
	Hot sticks	124
	Operating rods	125
	Fuse tongs	126
Accessories		
	General information	127
	Fuse testing devices	128
	Wall holders	129
	Accessories	130
Technical appendix		
	Dimension drawings	132 - 134
	Order inquiry	136 - 137
	Index	138 - 139
	Terms of delivery	140



Dipl.-Ing. H. Horstmann GmbH is a medium-sized company based in Heiligenhaus near Düsseldorf (Germany). The company was founded in 1946 by Heinrich Horstmann. Since that time it has been a successful family-owned company. Due to its long experience and the ongoing expansion activities in research and development as well as in production facilities Dipl.-Ing. H. Horstmann GmbH is today recognized as the leading manufacturer in medium voltage technology for:

- ▶ Short-circuit and earth fault indicators
- ▶ Solutions for remote monitoring
- ▶ Voltage detectors and voltage detecting systems
- ▶ Earthing devices and accessories

The worldwide distribution is covered by both our own highly qualified sales force and trade agents.

Our products meet the highest quality requirements and are developed and manufactured in our production facilities in Germany. In order to respond to these demands, we have a very high vertical depth of production (e. g. own SMD assembly lines) as well as an own research and development department with state-of-the-art testing and measuring equipment. Besides the electronics manufacturing, we have also a mechanical production facilities.

Since 1996 our company has been certified according to DIN EN ISO 9001.



Manufacturing



Component testing



High voltage laboratory

Short-circuit and earth fault indicators

General information

Horstmann offers a comprehensive range of short-circuit and earth fault indicators, which are characterised by extremely high reliability, top quality and state-of-the-art-functions.

There are different products and system solutions for medium voltage underground cable and overhead line networks with and without directional fault indication. They are suitable for radial, open ring and closed ring networks as well as for networks with a distributed generation. The following applies for all applications:

If a fault occurs:

- ▶ Quick identification of the fault location, immediate local indication and communication to SCADA
- ▶ Targeted de-energising/switching
- ▶ Quick supply restoration

This means: utilities can minimise the time and effort in searching for faults and benefit from high availability of energy supply. This helps them save costs and optimise their earnings.

With continuous monitoring:

- ▶ High transparency: Provision of high accuracy measurements from the distribution network
- ▶ Transmission of simple station reports like door contact, temperature alarm and status of the intelligent substation
- ▶ Simple upgrading of existing medium-voltage switchgear with retrofit solutions

With this, utilities will always have an overview of the situation in the network as well as be able to create predictive maintenance programs.

The product series for cable networks:

The Sigma series provides short-circuit and earth fault indicators for networks with a low-impedance neutral earthing.

The Sigma D series provides directional short-circuit and earth fault indicators for networks with a low-impedance resonant and isolated networks (Sigma D+ and Sigma D++) and neutral earthing with distributed energy generation.

The ComPass B series is for applications requiring highly accurate network monitoring in combination with directional fault indication. ComPass Bs 2.0 is used for applications where remote switching is required.

The diagram below shows two types of faults:

Left: A permanent fault that leads to line de-energisation when the circuit-breaker in the substation is opened. The short-circuit and earth fault indicators have tripped between substation and towards the fault location.

Right: A transient fault which does not lead to network de-energisation. The circuit-breaker remains closed. The short-circuit and earth fault indicators point from two directions to the fault location.

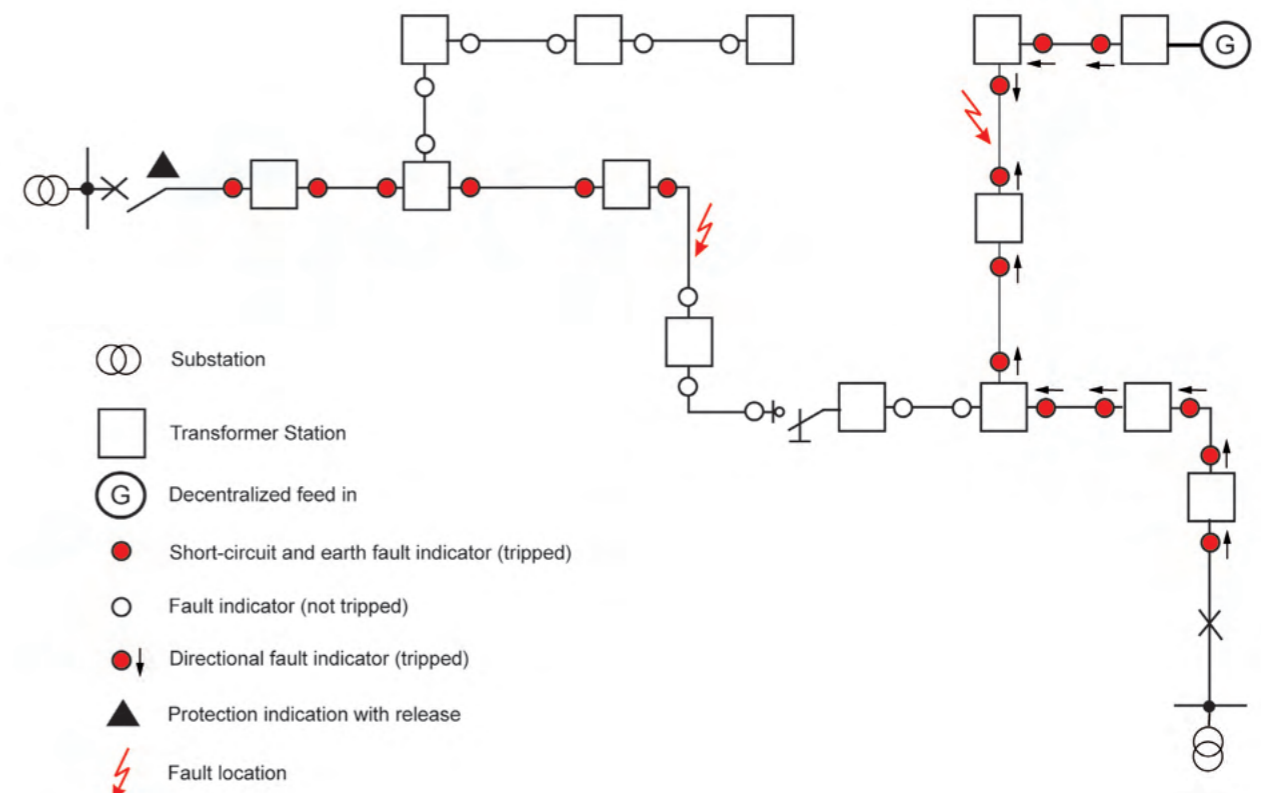

Product matrix

Short-circuit indicators



Function	Rotor indicator	Fluid indicator	Opto F 3.0	Sigma 2.0 / Sigma 2.0 AC/DC	Alpha M / Alpha E
Short-circuit indication / earth short-circuit indication	■	■	■	■	■
Earth fault indication	—	—	—	—	—
Directional indication	—	—	—	—	—
Monitoring	—	—	—	—	—
Control function and programmable logic	—	—	—	—	—
Neutral system					
Low-impedance earthed / short-term low-impedance earthed	■	■	■	■	■
Isolated earthed	—	—	—	—	—
Resonant earthed (with Petersen coil)	—	—	—	—	—
Short-circuit trip current values					
I>> Short-circuit trip current / earth short-circuit trip current	150—2,000 A (fixed settings)	400, 600, 1,000 A (fixed settings)	400, 600, 800 or 1,000 A	200, 300, 400, 600, 800, 1,000, 2,000 A, self-adjustment	400, 600, 800, 1,000 A
tI>> Response delay	100 ms	200 ms	40, 60, 80, 100, 200, 300 or 500 ms	40, 80 ms	100 ms
Earth fault detection methods					
IE> Earth fault trip current	—	—	—	—	—
IEP> Active residual current cos φ	—	—	—	—	—
IEQ> Reactive current sin φ	—	—	—	—	—
IET> Transient earth fault method	—	—	—	—	—
VNE> Neutral point displacement voltage (permanent earth fault)	—	—	—	—	—
IE> Pulse (stroke)	—	—	—	—	—
Response delay	—	—	—	—	—
Reset					
Manual/ Remote	■ / —	—	■ / ■	■ / ■	M: ■ / — E: ■ / ■
Automatic time reset	—	■	■	■	— ■
Current- / voltage- / auxiliary supply restoration	—	—	— / ■ / ■	— AC/DC: — / — / ■	—
Test					
Manual/ Remote	—	—	■ / ■	■ / ■	■ / —
Communication					
Relay contacts	on request	on request	1	1	1
Ethernet/ IEC 60870-5-104	—	—	—	—	—
RS485 / Modbus-RTU	—	—	—	—	—
USB port	—	—	—	—	—
Parameter setting					
Manual / remote / software via USB	—	—	■ / — / —	■ / — / —	■ / — / —
Power supply					
Long-life lithium cell / capacitor	— / —	— / —	■ / —	■ / — AC/DC: — / ■	■ (E) / —
CT powered	■	■	—	■ —	■
External auxiliary supply [V AC/DC]	—	—	24—60 V AC, 12—110 V DC	— 24—230	—
Number of current transformers (CT) / current sensor (S)					
Phase current / summation current	—	—	3 / — (CT)	3 / — (S)	3 / — (CT)
Voltage coupling					
Capacitive / resistive	—	—	—	—	—

Product matrix

Earth fault indicator



Function	Earth 4.0	Earth Zero	Earth Zero Flag
Short-circuit indication / earth short-circuit indication	—	—	—
Earth fault indication	■	■	■
Directional indication	—	—	—
Monitoring	—	—	—
Control function and programmable logic	—	—	—
Neutral system			
Low-impedance earthed / short-term low-impedance earthed	■	■	■
Isolated earthed	■	■	■
Resonant earthed (with Petersen coil)	—	—	—
Short-circuit trip current values			
I>> Short-circuit trip current / earth short-circuit trip current	—	—	—
tI>> Response delay	—	—	—
Earth fault detection methods			
IE> Earth fault trip current	25, 50, 60, 80 A	25, 50, 75, 100 A	25, 50, 75, 100 A
IEP> Active residual current cos φ	—	—	—
IEQ> Reactive current sin φ	—	—	—
IET> Transient earth fault method	—	—	—
VNE> Neutral point displacement voltage (permanent earth fault)	—	—	—
IE> Pulse (stroke)	—	—	—
Response delay	80, 160 ms	80, 160 ms	80, 160 ms
Reset			
Manual/ Remote	■ / ■	■ / —	■ / —
Automatic time reset	■	■	■
Current- / voltage- / auxiliary supply restoration	— / ■ / —	— / ■ / —	— / ■ / —
Test			
Manual/ Remote	■ / ■	■ / —	■ / —
Communication			
Relay contacts	3	1	1
Ethernet/ IEC 60870-5-104	—	—	—
RS485 / Modbus-RTU	—	—	—
USB port	—	—	—
Parameter setting			
Manual / remote / software via USB	■ / — / —	■ / — / —	■ / — / —
Power supply			
Long-life lithium cell / capacitor	■ / —	■ / —	■ / —
CT powered	■	■	■
External auxiliary supply [V AC/DC]	—	—	—
Number of current transformers (CT) / current sensor (S)			
Phase current / summation current	— / 1 (CT)	— / 1 (CT)	— / 1 (CT)
Voltage coupling			
Capacitive / resistive	—	—	—

Product matrix

Short-circuit and earth fault indicator



Function	Opto F+E 3.0	Sigma F+E 2.0 / Sigma F+E 2.0 AC/DC	Sigma F+E 3 2.0 / Sigma F+E 3 2.0 AC/DC	Sigma L/ Sigma F+E L/ Sigma F+E 3 L
Short-circuit indication / earth short-circuit indication	■	■	■	■
Earth fault indication	■	—	■	—/■/■
Directional indication	—	—	—	—
Monitoring	—	—	—	—
Control function and programmable logic	—	—	—	—
Neutral system				
Low-impedance earthed / short-term low-impedance earthed	■	■	■	■
Isolated earthed	—	—	■	—/■/■
Resonant earthed (with Petersen coil)	—	—	—	—
Short-circuit trip current values				
I>> Short-circuit trip current / earth short-circuit trip current	400, 600, 800 or 1,000 A	200, 300, 400, 600, 800, 1,000, 2,000 A, self-adjustment	200, 300, 400, 600, 800, 1,000, 2,000 A, self-adjustment	200, 300, 400, 600, 800, 1,000, 2,000 A, self-adjustment
tl>> Response delay	40, 60, 80, 100, 200, 300 or 500 ms	40, 80 ms	40, 80, 200, 300 ms	40, 80ms/40, 80ms/40, 80, 200, 300 ms
Earth fault detection methods				
IE> Earth fault trip current	10, 20, 40 or 80 A and 40, 80, 120 or 160 A	—	20, 40, 60, 80, 100, 120 or 160 A	—/ 20, 40, 60, 80, 100, 120 or 160 A
IEP> Active residual current cos φ	—	—	—	—
IEQ> Reactive current sin φ	—	—	—	—
IET> Transient earth fault method	—	—	—	—
VNE> Neutral point displacement voltage (permanent earth fault)	—	—	—	—
IE> Pulse (stroke)	—	—	—	—
Response delay	60, 100 or 200 ms	—	60, 80, 200 or 300 ms	—/ 80, 200 ms/ 60, 80, 200 or 300 ms
Reset				
Manual/ Remote	■/■	■/■	■/■	■/—
Automatic time reset	■	■	■	■
Current- / voltage- / auxiliary supply restoration	—/■/■	—	AC/DC: ■/—/— AC/DC: ■/—/■	—/—/■ ■/—/■ ■/—/■
Test				
Manual/ Remote	■/■	■/■	■/■	■/—
Communication				
Relay contacts	2	1	3	—
Ethernet/ IEC 60870-5-104	—	—	—	—
RS485 / Modbus-RTU	—	—	—	—
USB port	—	—	—	LoRaWAN modem
Radio 868 MHz / LoRaWAN protocol	—	—	—	■
Parameter setting				
Manual / remote / software via USB	■/—/—	■/—/—	■/—/—	■/—/■
Power supply				
Long-life lithium cell / capacitor	■/—	■/—	AC/DC: ■/— AC/DC: ■/—	—/■
CT powered	—	■	—	■
External auxiliary supply [V AC/DC]	24–60 VAC, 12–110 VDC	—	24–230	—
24–230	—	24–230	24–230	—
Number of current transformers (CT) / current sensor (S)				
Phase current / summation current	3/1 (CT)	3/— (S)	3/— (S)	3/— (S)
Voltage coupling				
Capacitive / resistive	—	—	—	—

Product matrix

Short-circuit and earth fault indicator



Function	ComPass A	ComPass A 2.0
Short-circuit indication / earth short-circuit indication	■	■
Earth fault indication	■	■
Directional indication	—	—
Monitoring	■	■
Control function and programmable logic	—	—
Neutral system		
Low-impedance earthed / short-term low-impedance earthed	■	■
Isolated earthed	■	■
Resonant earthed (with Petersen coil)	—	—
Short-circuit trip current values		
I>> Short-circuit trip current / earth short-circuit trip current	20–2,000 A	10–2,000 A, self-adjustment
tl>> Response delay	40 ms–60 s	20 ms–60 s
Earth fault detection methods		
IE> Earth fault trip current	20–1,000 A	10–1,000 A
IEP> Active residual current cos φ	—	—
IEQ> Reactive current sin φ	—	—
IET> Transient earth fault method	—	—
VNE> Neutral point displacement voltage (permanent earth fault)	—	—
IE> Pulse (stroke)	—	1–200 A
Response delay	40 ms–60 s	40 ms–60 s
Reset		
Manual/ Remote	■/■	■/■
Automatic time reset	■	■
Current- / voltage- / auxiliary supply restoration	■/—/—	■/—/■
Test		
Manual/ Remote	■/■	■/■
Communication		
Relay contacts	4	4
Ethernet/ IEC 60870-5-104	—	—
RS485 / Modbus-RTU	■	■
USB port	—	■
Parameter setting		
Manual / remote / software via USB	■/■/—	■/■/—
Power supply		
Long-life lithium cell / capacitor	■/—	■/—
CT powered	—	—
External auxiliary supply [V AC/DC]	24–230	24–230
Number of current transformers (CT) / current sensor (S)		
Phase current / summation current	3/— (S)	3/— (S)
Voltage coupling		
Capacitive / resistive	—	—

Product matrix

Directional fault indicators



Function	Sigma D	Sigma D+	Sigma D++	Sigma DM
Short-circuit indication / earth short-circuit indication	■	■	■	■
Earth fault indication	■	■	■	■
Directional indication	■	■	■	■
Monitoring	—	—	—	■
Control function and programmable logic	—	—	—	—
Neutral system				
Low-impedance earthed / short-term low-impedance earthed	■	■	■	■
Isolated earthed	■	■	■	■
Resonant earthed (with Petersen coil)	—	■	■	■
Short-circuit trip current values				
I>> Short-circuit trip current / earth short-circuit trip current	DIP: 200, 300, 400, 600, 800, 2,000 A, self-adjustment SW: 50–2,000 A	DIP: 200, 300, 400, 600, 800, 2,000 A, self-adjustment SW: 50–2,000 A	DIP: 200, 300, 400, 600, 800, 2,000 A, self-adjustment SW: 50–2,000 A	DIP: 400, 800, 1,000, 2,000 A, self-adjustment SW: 50–2,000 A
tl>> Response delay	DIP: 40, 80 ms, SW: 40 ms–60 s	DIP: 40, 80 ms, SW: 40 ms–60 s	DIP: 40, 80 ms, SW: 40 ms–60 s	DIP: 40, 80 ms, SW: 40 ms–60 s
Earth fault detection methods				
IE> Earth fault trip current	DIP: off, 20, 40, 60, 80, 100, 120, 160 A SW: 20–1,000 A	DIP: off, 20, 40, 60, 80, 100, 120, 160 A SW: 20–1,000 A	DIP: off, 20, 40, 60, 80, 100, 120, 160 A SW: 20–1,000 A	SW: 20–1,000 A
IEP> Active residual current cos φ	—	5–200 A	5–200 A	1–200 A
IEQ> Reactive current sin φ	—	5–200 A	5–200 A	1–200 A
IET> Transient earth fault method	—	10–100 A	10–500 A	10–500 A
VNE> Neutral point displacement voltage (permanent earth fault)	—	—	—	1–100%
IE> Pulse (stroke)	—	1–100 A	1–100 A	1–100 A
Response delay	DIP: 80, 160 ms, SW: 40 ms–60 s	DIP: 80, 160 ms, SW: 40 ms–60 s	DIP: 80, 160 ms, SW: 40 ms–60 s	SW: 40 ms–60 s
Reset				
Manual/ Remote	■/■	■/■	■/■	■/■
Automatic time reset	■	■	■	■
Current- / voltage- / auxiliary supply restoration	■/■/—	■/■/—	■/■/—	■/■/—
Test				
Manual/ Remote	■/■	■/■	■/■	■/■
Communication				
Relay contacts	4	4	4	—
Ethernet/ IEC 60870-5-104	—	—	—	—
RS485 / Modbus-RTU	—	—	—	■
USB port	■	■	■	■
Parameter setting				
Manual / remote / software via USB	■/—/■	■/—/■	■/—/■	■/—/■
Power supply				
Long-life lithium cell / capacitor	■/—	■/—	■/—	■/—
CT powered	■	■ (from 3A)	■ (not IET>)	■ (not IET>)
External auxiliary supply [V AC/DC]	—	24–60V DC/ 24V AC	24–230 (for IET>)	24–230 (for IET>)
Number of current transformers (CT) / current sensor (S)				
Phase current / summation current	3/— (S)	3/1, opt. 3/— (S)	3/—, opt. 3/1 (S)	3/— (S)
Voltage coupling				
Capacitive / resistive	■/—	■/—	■/—	■/—

Product matrix

Directional fault indicators



Function	ComPass B	ComPass B 2.0	ComPass Bs 2.0	ComPass D
Short-circuit indication / earth short-circuit indication	■	■	■	■
Earth fault indication	■	■	■	■
Directional indication	■	■	■	■
Monitoring	■	■	■	■
Control function and programmable logic	—	—	1 switchgear	2 switchgears
Neutral system				
Low-impedance earthed / short-term low-impedance earthed	■	■	■	■
Isolated earthed	■	■	■	■
Resonant earthed (with Petersen coil)	■	■	■	■
Short-circuit trip current values				
I>> Short-circuit trip current / earth short-circuit trip current	50–2,000 A	10–2,000 A, self-adjustment	10–2,000 A self-adjustment	10–2,000 A self-adjustment
tl>> Response delay	40 ms–60 s	20 ms–60 s	20 ms–60 s	20 ms–60 s
Earth fault detection methods				
IE> Earth fault trip current	20–1,000 A	10–1,000 A	10–1,000 A	10–1,000 A
IEP> Active residual current cos φ	1–200 A	1–200 A	1–200 A	1–200 A
IEQ> Reactive current sin φ	1–200 A	1–200 A	1–200 A	1–200 A
IET> Transient earth fault method	—	10–500 A	10–500 A	10–500 A
VNE> Neutral point displacement voltage (permanent earth fault)	0–100%	1–100%	1–100%	1–100%
IE> Pulse (stroke)	—	1–200 A	1–200 A	1–200 A
Response delay	40 ms–60 s	40 ms–60 s	40 ms–60 s	40 ms–60 s
Reset				
Manual/ Remote	■/■	■/■	■/■	■/■
Automatic time reset	■	■	■	■
Current- / voltage- / auxiliary supply restoration	■/■/■	■/■/■	■/■/■	■/■/■
Test				
Manual/ Remote	■/■	■/■	■/■	■/■
Communication				
Relay contacts	4	4	4	4
Ethernet/ IEC 60870-5-104	—	—	—	■
RS485 / Modbus-RTU	■	■	■	—
USB port	—	■	■	■
Parameter setting				
Manual / remote / software via USB	■/■/—	■/■/■	■/■/■	■/■/■
Power supply				
Long-life lithium cell / capacitor	■/—	■/—	■/—	■/—
CT powered	—	—	—	—
External auxiliary supply [V AC/DC]	24–230	24–230	24–230	24
Number of current transformers (CT) / current sensor (S)				
Phase current / summation current	2/1, opt. 3/— for IÉ> 10 A (S)	3/—, opt. 3/1 or 2/1 (S)	3/—, opt. 3/1 or 2/1 (S)	3/—
Voltage coupling				
Capacitive / resistive	■/—	■/■	■/■	■/■

Rotor indicator

Short-circuit indicator

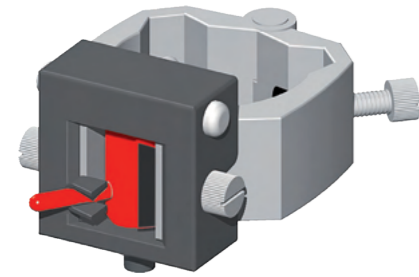

Rotor indicator

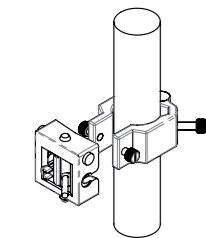

Installation

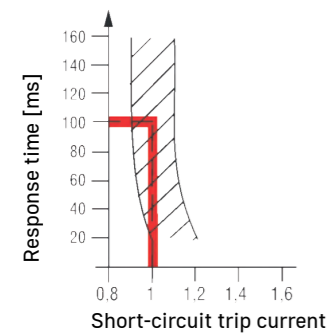

Response characteristic

I_{min} [A]	for \varnothing [mm]	Order no.	Accessories	Page
150	8–16	20-0101-001 ¹⁾	Hot stick	124
200	16–20	20-0102-001		
200	20–30	20-0103-001		
200	30–40	20-0104-001		
200	40–50	20-0105-001		
300	50–60	20-0106-001		
300	60–80	20-0108-001		
I_{min} [A]	for \varnothing [mm]	Order no.		
150	20 x 4–25 x 6	20-0122-001 ¹⁾		
150	25 x 4–30 x 6	20-0123-001 ¹⁾		
200	30 x 4–40 x 10	20-0120-001 ¹⁾		
300	45 x 4–60 x 12	20-0121-001 ¹⁾		

¹⁾ Screws for fixing the conductor made of steel
 Combined rotor / fluid short-circuit indicators are available on request.
 Product matrix on page 10
 Dimension drawing see on page 132 ff. | M1

PRODUCT FEATURES

- ▶ Mechanical design
- ▶ Installation on cables or busbars
- ▶ Fault indication by pivoted rotor
- ▶ Retrofit ready

YOUR ADVANTAGES

- ▶ Universal use
- ▶ Reliable fault detection during re-energising
- ▶ Maintenance-free, no battery

The rotor indicator is a mechanical short-circuit indicator. It is designed to detect short-circuit currents in medium voltage distribution networks. The indicator is tripped by a magnetic field strength "H" which is induced by trip values $I_{>>}$. The pivoted rotor with reset pin uses a two-colour indication to inform the user of the state of the Rotor Indicator. "Black" means that the indicator has not been tripped whereas "red" indicates that the indicator has been tripped.

Technical data	Rotor indicator
Short-circuit indicator	■
Earth fault detection method	Earth short-circuit
$I_{>>}$ Short-circuit trip current	150–2,000 A (factory setting)
$t_{I>>}$ Response delay	100 ms at rated trip value
Accuracy	±10 %
Reset	Manual reset with hot stick
Material	Housing and fixing screws made from polyamide, Yoke made from ferromagnetic steel
Temperature range	-40 to +85 °C

Fluid indicator

Short-circuit indicator

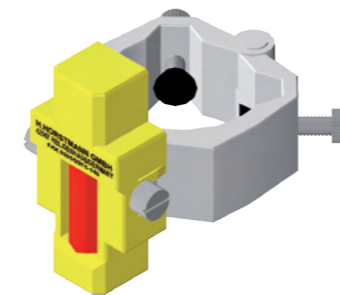

Fluid indicator

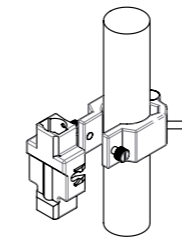

Installation

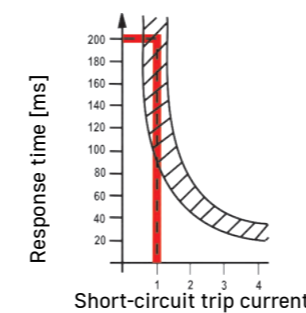

Response characteristic

I_{min} [A]	for \varnothing [mm]	Order no.
400	8–16	20-0401-000 ¹⁾
400	16–20	20-0402-000
400	20–30	20-0403-000
400	30–40	20-0404-000
600	40–50	20-0405-000
600	50–60	20-0406-000
1,000	60–80	20-0408-000
I_{min} [A]	for \varnothing [mm]	Order no.
400	30 x 4–40 x 10	20-0420-000 ¹⁾
400	20 x 4–25 x 6	20-0422-000 ¹⁾
400	25 x 4–30 x 6	20-0423-000 ¹⁾
600	45 x 4–60 x 12	20-0421-000 ¹⁾
I_{min} [A]	for \varnothing [mm]	Order no.
400	30 x 4–40 x 15	20-0410-000 ¹⁾

¹⁾ Screws for fixing the conductor made of steel
 Combined rotor / fluid short-circuit indicators are available on request.
 Product matrix on page 10
 Dimension drawing see on page 132 ff. | M2

PRODUCT FEATURES

- ▶ Mechanical design
- ▶ Installation on cables or busbars
- ▶ Fault indication by fluid with red coloured particles
- ▶ Retrofit ready

YOUR ADVANTAGES

- ▶ Universal use
- ▶ Automatic reset
- ▶ Maintenance-free, no battery

The fluid indicator is a mechanical short-circuit indicator which is designed to detect short-circuit currents in medium voltage distribution networks.

The indicator is tripped by a magnetic field strength "H" which is induced by trip values $I_{>>}$. When a short-circuit occurs, the mixer is pulled up by the magnetic field stirring up red particles in the fluid. The indication resets automatically after six to eight hours once the red particles have set to the bottom of the mixer.

Technical data	Fluid indicator
Short-circuit indicator	■
Earth fault detection method	Earth short-circuit
$I_{>>}$ Short-circuit trip current	400, 600, 1,000 A (factory setting)
$t_{I>>}$ Response delay	200 ms at rated trip value (100 ms are available on request)
Accuracy	±20 %
Reset	Automatic reset by time after approx. 6–8 h
Material	Housing and fixing screws made from polyamide, Yoke made from ferromagnetic steel
Temperature range	-40 °C bis +85 °C

Opto F 3.0

Short-circuit indicator



Opto F 3.0, plug-in housing



Opto F 3.0, Surface mount housing

PRODUCT FEATURES

- ▶ Fibre optic cables for electrical isolation between indicator and current transformers
- ▶ High-intensity LED indication
- ▶ Single and double flash mode for operation in radial and ring networks
- ▶ Remote indication via relay contact
- ▶ Current transformer retrofit ready

YOUR ADVANTAGES

- ▶ Installation on bare cables and busbars/copper conductors
- ▶ New fault detection within reset time

The Opto F 3.0 is a short-circuit indicator. It is designed to detect, display and remotely indicate short-circuit currents in medium voltage distribution networks. The indicator unit can be used in all medium voltage switchgear installations. Fibre optic cables provide electrical isolation between the current transformers, mounted on cable/busbar, and the display unit when transferring signals.

The current transformers (CT) have an integrated trip threshold detection capability. When the pre-set trip current is reached or exceeded, light pulses will be emitted. A fibre optic cable is used to transmit these light pulses from the CT to the Opto. Phase-selectively operated red LEDs start flashing.

After the first tripping incident (e. g. in radial systems) the LEDs begin a phase-selective flash rhythm of: flash / pause / flash.

A second tripping (e. g. ring operated network with auto-reclosing) is indicated by flashing LEDs of the fault-affected phases in a flash-flash / pause / flash-flash rhythm.

Technical data	Opto F 3.0
Short-circuit indicator	■
Earth fault detection method	Earth short-circuit
I _{>>} short-circuit trip current	400, 600, 800, 1,000 A ¹⁾ (adjustable at the CT)
t _{l>>} response delay	40, 60, 80, 100, 200, 300, 500 ms (adjustable at the display unit)
Accuracy	±15 % (determined by current transformer)
Indication	Phase-selective short-circuit: 3 red LEDs, flashing period 2 s, double flash sequence 0.3 s with flashing period 3 s Optional: external signal lamp
Remote signal / communication	1 relay contact
Remote contact	Potential-free permanent or momentary contact Contact capacity: 380 V AC / 5 A / 1250 VA max.; 220 V DC / 5 A / 150 W max.
Reset	<ul style="list-style-type: none"> ▶ By button ▶ Automatic time reset: 1, 2, 4 or 8 h ▶ Restoration of auxiliary supply ≥10 s (activated via DIP switch) ▶ Remote reset
Power supply	
Internal power supply	Long-life lithium cell, active flashing time >1,000 h, shelf life ≥20 years
External auxiliary supply	12–110 V DC ±10 % or 24–60 V AC (±10 %), 50–60 Hz (optional)
Optional accessories	Transformer with cable for top-hat rail or screw mounting (115–230 V AC / 24–48 V AC)
Temperature range	-30 to +70 °C

Equipment set	Page	Order no.	Accessories	Page
1 Display unit			External signal lamp	58
Opto F 3.0, plug-in housing		33-0513-001	Transformer for top-hat rail	59
Opto F 3.0, surface mount housing		33-0613-001	Cutting tool for fibre optic cables	59
3 Single-phase current sensors	48		Optical testing unit	59
3 Fibre optic cables	59		Disassembly clip	59
			Spring clip	59

¹⁾ Further trip currents on request.

Dimension drawing see on page 132 ff. | M3

Sigma 2.0

Short-circuit indicator



Sigma 2.0



Sigma 2.0 AC/DC

PRODUCT FEATURES

- ▶ Short-circuit indicator for all medium voltage networks
- ▶ Phase-selective fault indication
- ▶ Trip current values: load-dependent self-adjustment or fixed values
- ▶ Single and double flash mode for operation in radial and ring networks
- ▶ With auxiliary supply and back-up capacitor available in AC/DC version

YOUR ADVANTAGES

- ▶ No false trips due to higher harmonics
- ▶ Highly visible LED fault indication
- ▶ Retrofit ready for short-circuit and earth fault indicators with monitoring/control and fault direction function

The Sigma 2.0 is a phase-selective short-circuit indicator. It is designed to detect, display and remotely indicate short-circuits in medium voltage distribution networks.

The current is measured via three Single-phase current sensors. By using the new sensors retrofit to more advanced indicator series is possible at any time – without changing the sensors.

There are two response criteria for short-circuit detection, fixed response value with response delay or auto-adjustment based on load current.

If the current for the selected response criterion – fixed value or self-adjustment – is exceeded, the fault-affected phase will be indicated by a bright flashing LED and remote contact will be activated. A double flashing LED signals a second fault that has occurred within the reset time, e. g. by an automatic reclose attempt and the remote contact will be reactivated.

For testing and commissioning purposes, the trip current values can be reduced to 10 A without changing the DIP switch settings.

Sigma 2.0 AC/DC

This version can be connected to auxiliary supply. If the auxiliary power drops out in the event of a fault, the LED indicator can operate using a back-up capacitor for up to 8 hours.

Technical data	Sigma 2.0
Short-circuit indicator	■
Earth fault detection method	Earth short-circuit
I>> short-circuit trip current	200, 300, 400, 600, 800, 1,000, 2,000 A Self-adjustment to load current (IL = load current): IL < 100 A → I>> = 400 A, IL > 100 A → I>> = 4 x IL
tI>> response delay	40, 80 ms
Accuracy	5 % (0–630 A) 10 % (>630 A)
Indication	3 red LEDs: 3 x short-circuit (L1, L2, L3)
Remote signal / communication	1 potential-free relay contact
Remote contact	Potential-free permanent or momentary contact Contact capacity: 230 V AC / 1 A / 62.5 VA max.; 220 V DC / 1 A / 60 W max.
Reset	<ul style="list-style-type: none"> ▶ By button ▶ Automatic time reset: 1, 2, 4 or 8 h ▶ Remote reset
Power supply	
CT powered	■
Internal power supply	Long-life lithium cell, active flashing time >900 h, shelf life ≥20 years AC/DC version: back-up capacitor, max. 8 h
External auxiliary supply	AC/DC version: 24–230 V AC/DC
Housing	Polycarbonate, IP40
Temperature range	–30 °C to +70 °C

Equipment set	Page	Order no.	Accessories	Page
1 Display unit			Connection to remote monitoring	71
Sigma 2.0		37-1111-101	Wall-mounted housing	58
Sigma 2.0 AC/DC		37-1121-101	External signal lamp	58
3 Single-phase current sensors	54		Disassembly clip	59
			Spring clip	59

Dimension drawing see on page 132 ff. | M3

Alpha M | Alpha E

Short-circuit indicator



Alpha M



Alpha E

PRODUCT FEATURES

- ▶ Adjustable trip currents
- ▶ Flag-type indication (black / red)
- ▶ Remote signal

YOUR ADVANTAGES

- ▶ Maintenance-free, no battery (Alpha M)
- ▶ Remote reset (Alpha E)

The Alpha is designed to detect, display and remotely indicate short-circuit faults in medium voltage distribution networks.

The indication is tripped by a short-circuit current and remains active until the device is reset.

If a new device is connected to the CTs that are already installed in the switchgear, the Alpha must be factory-calibrated to match the existing CTs.

Technical data	Alpha M	Alpha E
Short-circuit indicator	■	■
Earth fault detection method	Earth short-circuit	
I>> short-circuit trip current	400, 600, 800, 1,000 A	
tl>> response delay	100 ms, no tripping <20 ms	
Accuracy	±15 %	
Indication	3 display elements (black / red), bi-stable type, for L1, L2, L3	
Remote signal / communication	1 relay contact	
Remote contact	Potential-free permanent and momentary contact (>100 ms) Contact capacity: 230 V AC / 1 A / 62.5 VA max.; 220 V DC / 1 A / 60 A max.	
Reset	▶ Via rotary knob	▶ By button ▶ Remote reset: 12–60 V AC/DC ±10 % ▶ Automatic time reset: 2 or 4 h
Power supply		
CT powered	■	■
Internal power supply	—	Long-life lithium cell, shelf life ≥20 years
Housing	Polycarbonate, IP40	
Temperature range	-30 °C to +70 °C	

Equipment set	Page	Order no.	Accessories	Page
1 Display unit			Wall-mounted housing	64
Alpha M		30-1815-001	External signal lamp	64
Alpha E		30-1715-001	Disassembly clip	65
3 Single-phase current sensors	50		Spring clip	65

Dimension drawing see on page 132 ff. | M3/M5

Earth 4.0

Earth fault indicator



Earth 4.0

PRODUCT FEATURES

- ▶ Indication of earth fault currents by LED and mechanical flag
- ▶ Remote indication, test and reset by relay contacts
- ▶ Battery status indication and remote indication via relay contact

YOUR ADVANTAGES

- ▶ Connection to remote monitoring
- ▶ Early warning of battery end-of-life

The Earth 4.0 is an earth fault indicator. It is designed to detect, locally indicate and remotely report earth fault currents in medium voltage distribution networks. A wired earth fault current transformer monitors the summation current of all three conductors. The electronics of the display unit evaluates the measurements. When the fault sensitivity threshold is exceeded, a red LED will start flashing and a mechanical flag becomes visible. In addition to that, the remote indication contacts are energised. A system-specific external signal lamp is optionally available.

Technical data	Earth 4.0
Short-circuit indicator	■
Earth fault detection method	25, 50, 60, 80 A ¹⁾
I>> short-circuit trip current	80, 160 ms ¹⁾
tl>> response delay	±10 %
Accuracy	▶ 1 red LED, flash rate 2 s ▶ 1 yellow LED (battery status), flash rate 2 s ▶ Mechanical flag
Indication	▶ 2 relay contacts (change over) for earth fault indication ▶ 1 relay contact (change over) for battery status indication
Remote signal / communication	Potential-free permanent and momentary contact (1 s) Contact capacity: 230 V AC / 1 A / 62.5 VA max.; 220 V DC / 1 A / 60 A max.
Remote contact	▶ By button ▶ Remote contact ▶ Automatic time reset: 1, 2, 4 or 8 h ▶ Voltage restoration (220–240 V AC, ≥10 %)
Power supply	
CT powered	■
Internal power supply	Long-life lithium cell, shelf life ≥20 years, total flashing time ≥1,200 h
Housing	Polycarbonate, IP40
Temperature range	-30 °C to +70 °C

Equipment set	Page	Order no.	Accessories	Page
1 Display unit Earth 4.0		32-0504-XXX	External signal lamp	58
1 Summation current transformer	51			

¹⁾ Further trip currents and / or response delays on request.

Dimension drawing see on page 132 ff. | M7

Earth Zero | Earth Zero Flag

Earth fault indicator



Earth Zero, plug-in housing



Earth Zero, surface mount housing



Earth Zero Flag, plug-in housing



Earth Zero Flag, surface mount housing

PRODUCT FEATURES

- ▶ Indication of earth fault currents by LED and mechanical flag
- ▶ Remote indication
- ▶ Optional: External signal lamp

YOUR ADVANTAGES

- ▶ LED for fast and clear indication
- ▶ Connection to remote monitoring
- ▶ Fault detection without opening/entering the substation in combination with the external signal lamp

The Earth Zero is an earth fault indicator. It is designed to detect, locally indicate and remotely report earth fault currents in medium voltage distribution networks. A wired earth fault current transformer monitors the summation current of all three conductors. The electronics of the display unit evaluates the measurements.

When the fault sensitivity threshold is exceeded, a red LED will start flashing and a mechanical flag becomes visible (Earth Zero Flag). A system-specific external signal lamp is optionally available.

Technical data	Earth Zero	Earth Zero Flag
Earth fault indicator	■	■
IE> earth fault trip current	25, 50, 75, 100 A ¹⁾	
tIE> response delay	80, 160 ms ¹⁾	
Accuracy	±15 %	
Indication	1 red LED, flash rate 2 s	1 red LED, flash rate 2 s + mechanical flag
Remote signal / communication	1 relay contact and input for external signal lamp	
Remote contact	Potential-free permanent and momentary contact (1 s) Contact capacity: 230 V AC / 1 A / 62.5 VA max.; 220 V DC / 1 A / 60 A max.	
Reset	<ul style="list-style-type: none"> ▶ By button ▶ Automatic time reset: 2, 4 or 8 h ▶ Voltage restoration (110 – 240 V AC) 	
Power supply		
CT powered	■	
Internal power supply	Long-life lithium cell, shelf life ≥20 years, total flashing time ≥1,200 h (>500 h when using the external signal lamp)	
Housing	Polycarbonate, IP40 (plug-in housing), IP65 (surface mount housing)	
Temperature range	-30 °C to +70 °C	

Equipment set	Page	Order no.	Accessories	Page
1 Display unit			External signal lamp	58
Earth Zero, Plug-in housing		32-0513-001		
Earth Zero, Surface mount housing		32-0503-001		
Earth Zero Flag, Plug-in housing	58	32-0512-002		
Earth Zero Flag, Surface mount housing		32-0502-002		
1 Summation current transformer	51			

¹⁾ Further trip currents and/or response delays on request.

Dimension drawing see on page 132 ff. | M6/M7

Opto F+E 3.0

Short-circuit and earth fault indicator



Opto F+E 3.0, Plug-in housing



Opto F+E 3.0, Surface mount housing

PRODUCT FEATURES

- ▶ Fibre optic cables for electrical isolation between indicator and current transformers
- ▶ High-intensity LED indication
- ▶ Single and double flash mode for operation in radial and ring networks
- ▶ Remote indication via relay contact
- ▶ Current transformer retrofit ready

YOUR ADVANTAGES

- ▶ Installation on bare cables and busbars
- ▶ New fault detection within reset time

The Opto F+E 3.0 device is a combined short-circuit and earth fault indicator. It is designed to detect, display and remotely indicate short-circuit currents and earth faults in medium voltage distribution networks. The indicator unit can be used in all medium voltage switchgear installations. Fibre optic cables provide electrical isolation between the current transformers, mounted on cable/busbar, and the display unit when transferring signals. Due to its measuring principle, the earth fault indication is suitable for low-impedance or solidly earthed neutral networks as well as for radial or open ring networks.

The current transformers (CT) have an integrated trip threshold detection capability. When the pre-set trip current is reached or exceeded, light pulses will be emitted. A fibre optic cable is used to transmit these light pulses from the CT to the Opto. Phase-selectively operated red LEDs start flashing.

After the first tripping incident (e. g. in radial systems) the LEDs begin a phase-selective flash rhythm of: flash / pause / flash.

A second tripping (e. g. ring operated network with auto-reclosing) is indicated by flashing LEDs of the fault-affected phases in a flash-flash / pause / flash-flash rhythm.

Technical data	Opto F+E 3.0
Short-circuit indicator	■
Earth fault indicator	■
Earth fault detection method	Earth short-circuit
I>> short-circuit trip current	400, 600, 800, 1,000 A ¹⁾ (adjustable at the CT)
tI>> response delay	40, 60, 80, 100, 200, 300, 500 ms (adjustable at the display unit)
I>E> earth fault trip current	10, 20, 40, 80 A or 40, 80, 120, 160 A (adjustable at the CT)
tI>E> response delay	60, 100 or 200 ms (adjustable at the display unit)
Accuracy	±15 % (determined by current transformer)
Indication	Phase-selective short-circuit: 3 red LEDs, flashing period 2 s, double flash sequence 0.3 s with flashing period 3 s Optional: external signal lamp
Remote signal / communication	1 relay contact
Remote contact	Potential-free permanent or momentary contact Contact capacity: 380 V AC / 5 A / 1250 VA max.; 220 V DC / 5 A / 150 W max.
Reset	<ul style="list-style-type: none"> ▶ By button ▶ Automatic time reset: 1, 2, 4 or 8 h ▶ Restoration of auxiliary supply ≥10 s (activated via DIP switch) ▶ Remote reset
Power supply	
Internal Power supply	Long-life lithium cell, active flashing time >1,000 h, shelf life ≥20 years
External auxiliary supply	12–110 V DC ±10 % or 24–60 V AC (±10 %), 50–60 Hz (optional)
Accessories	Transformer with cable for top-hat rail or screw mounting (115 - 230 V AC / 24 - 48 V AC)
Housing	Polycarbonate, IP40 (Plug-in housing), IP65 (Surface mount housing)
Temperature range	-30 °C to +70 °C

Equipment set	Page	Order no.	Accessories	Page
1 Display unit			External signal lamp	58
Opto F+E 3.0, Plug-in housing		36-0323-001	Transformer with cable for top-hat rail	59
Opto F+E 3.0, Surface mount housing		36-0313-001	Cutting tool for fibre optic cables	59
3 Single-phase current sensors	48		Optical testing unit	59
1 Summation current transformer	51		Disassembly clip	59
4 Fibre optic cables	59		Spring clip	59

¹⁾ Further trip currents and / or response delays on request.

Dimension drawing see on page 132 ff. | M3/M7

Sigma F+E 2.0 | Sigma F+E 3 2.0

Short-circuit and earth fault indicator



Sigma F+E 2.0



Sigma F+E 2.0 AC/DC



Sigma F+E 3 2.0



Sigma F+E 3 2.0 AC/DC

PRODUCT FEATURES

- ▶ Short-circuit and earth fault detection from 3 Single-phase current sensors
- ▶ Phase-selective fault indication
- ▶ Trip current values: load-dependent self-adjustment or fixed values
- ▶ Single and double flash mode for operation in radial and ring networks
- ▶ With auxiliary supply and back-up capacitor available in AC/DC version

YOUR ADVANTAGES

- ▶ No false trips due to higher harmonics
- ▶ Highly visible LED fault indication
- ▶ Detection of high-impedance earth faults
- ▶ Clear fault type indication via LED (Sigma F+E 3 2.0)
- ▶ Retrofit ready for earth fault and short-circuit indicators with monitoring/control and fault direction function

Sigma F+E 2.0 and Sigma F+E 3 2.0 are combined short-circuit and earth fault indicators. Due to the measuring principle the earth fault indication is suitable for networks with low-impedance, solid and isolated neutral earthing..

The current is measured via three Single-phase current sensors. This allows phase-selective fault detection and indication.

There are two response criteria for short-circuit detection, fixed response values with response delay or auto-adjustment based on load current.

If the current for the selected response criterion – fixed value or self-adjustment – is exceeded, the fault-affected phase will be indicated by a bright flashing LED and remote contact will be activated. A double flashing LED signals a second fault that has occurred within the reset time, e. g. by an automatic reclose attempt and the remote contact will be reactivated.

For testing and commissioning purposes, the trip current values can be reduced to 10 A without changing the DIP switch settings.

Sigma F+E 3 2.0

The red LED I>> signals a short-circuit, the yellow LED I_{E>} signals an earth fault. The L1, L2 and L3 indication fields display the fault-affected phase. In addition, phase-selective (L1, L2, L3) or group-selective (I>>, I_{E>}, I>> and I_{E>}) remote signalling is possible.

Sigma F+E 2.0 AC/DC and Sigma F+E 3 2.0 AC/DC

These versions can be connected to auxiliary supply. If the auxiliary power drops out in the event of a fault, the LED indicator can operate using a back-up capacitor for up to 8 hours.

Technical data	Sigma F+E 2.0	Sigma F+E 3 2.0
Short-circuit indicator	■	■
Earth fault indicator	■	■
Earth fault detection method	Earth short-circuit	
I>> short-circuit trip current	200, 300, 400, 600, 800, 1,000, 2,000 A Self-adjustment to load current (I _L =load current): I _L < 100 A → I>> = 400 A, I _L > 100 A → I>> = 4 x I _L	
tI>> response delay	40 ms, 80 ms	40, 80, 200, 300 ms
I _{E>} earth fault trip current	20, 40, 60, 80, 100, 120, 160 A	
tI _{E>} response delay	80, 160 ms	60, 80, 200, 300 ms
Accuracy	±5 % (0–630 A) ±10 % (>630 A)	
Indication	3 red phase-selective LEDs: short-circuit 2 or 3 phases (L1, L2, L3) and earth fault 1 phase	LED indication 3 red phase-selective LEDs L1, L2, L3 1 red LED short-circuit I>> 1 yellow LED earth fault I _{E>}
Remote signal / communication	2 potential-free relay contact	3 potential-free relay contact
Remote contact	Potential-free permanent or momentary contact Contact capacity: 230 V AC / 1 A / 62.5 VA max.; 220 V DC / 1 A / 60 W max.	
Reset	<ul style="list-style-type: none"> ▶ By button ▶ Automatic time reset: 1, 2, 4 or 8 h ▶ Remote reset 	<ul style="list-style-type: none"> ▶ By button ▶ Remote reset ▶ Automatic time reset: 2, 4, 8 or 24 h ▶ Current restoration
Power supply	<ul style="list-style-type: none"> CT powered ■ Internal power supply Long-life lithium cell, active flashing time >900 h, shelf life ≥20 years AC/DC version: back-up capacitor, max. 8 h External auxiliary supply AC/DC version: 24–230 V AC/DC 	
Housing	Polycarbonate, IP40	
Temperature range	–30 °C to +70 °C	

Equipment set	Page	Order no.	Accessories	Page
1 Display unit			Connection to remote monitoring	71
Sigma F+E 2.0		37-2111-101	Wall-mounted housing	58
Sigma F+E 2.0 AC/DC		37-2121-101	External signal lamp	58
Sigma F+E 3 2.0		37-5113-101	Disassembly clip	59
Sigma F+E 3 2.0 AC/DC		37-5123-101	Spring clip	59
3 Single-phase current sensors	50			

Dimension drawing see on page 132 ff | M3 Data Standard

Sigma L

Short-circuit and earth fault indicator with communication via LoRaWAN



Sigma L

PRODUCT FEATURES

- ▶ Detection of short circuits and earth faults using only three Single-phase current sensors
- ▶ Phase-selective fault indication
- ▶ Short circuit: load-dependent self-adjustment or fixed trip current thresholds
- ▶ Single and double flash modes for radial and ring networks with auxiliary power connection and back-up capacitor for fault indication
- ▶ Remote data transmission via LoRaWAN radio module
- ▶ Available in three versions:
 - ▶ Sigma L
 - ▶ Sigma F+E L
 - ▶ Sigma F+E 3 L

YOUR ADVANTAGES

- ▶ Cost-effective data transmission solution
- ▶ Secure communication within a public radio network
- ▶ Highly visible LED fault indication
- ▶ Detection of low-impedance earth faults
- ▶ Transformer-powered supply for local fault indication

The distinctive feature of the Sigma L series is the capability for remote data transmission over the 868 MHz radio frequency using the LoRaWAN protocol. In the event of a fault, data transmission is secured for 1 minute after the loss of auxiliary power, ensuring secure data transfer to the LoRaWAN gateway.

The current measurement of the Sigma 2.0 L series is performed using three Single-phase current sensors. This allows for phase-selective fault detection and indication. For short-circuit detection, you can choose between two criteria — fixed trip current thresholds with response delay or self-adjustment based on the load current.

If the current exceeds the selected response criterion — either the fixed thresholds or self-adjustment — the LED of the corresponding phase will blink, and the remote signalling contact will be activated.

If a second tripping occurs within the reset time, such as due to an automatic reclosing, this will be indicated by a double-flashing display, and the remote signalling contact will be reactivated. For testing and commissioning purposes, the current response values can be reduced to 10 A without changing the DIP switch settings. In two variants, separate earth fault detection for low-impedance or solidly earthed medium-voltage networks is available.

Sigma L

Short-circuit indicator, whereby the display fields L1, L2 and L3 indicate the fault phase-selectively.

Sigma F+E L

Short-circuit and earth fault indicator, whereby the display fields L1, L2 and L3 display the fault phase-selectively. The earth fault is calculated separately and displayed as a single-phase fault.

Sigma F+E 3 L

The red LED I>> signals the short circuit, the yellow LED IE> the earth fault, whereby the display fields L1, L2 and L3 display the fault phase-selectively.

The Sigma F+E 3 L also has phase-selective (L1, L2, L3) or group-selective (I>>, IE>, I>> and IE>) remote signalling via LoRaWAN.

Technical data	Sigma L	Sigma F+E L	Sigma F+E 3 L
Short-circuit indicator	■	■	■
Earth fault indicator	■	■	■
Earth fault detection method	Earth short-circuit		
I>> short-circuit trip current	200, 300, 400, 600, 800, 1,000, 2,000 A Self-adjustment to load current : IB < 100 A → I>> = 400 A, IB > 100 A → I>> = 4 x IB		
tI>> response delay	40 ms, 80 ms	40 ms, 80 ms	40, 80, 200, 300 ms
IE> earth fault trip current	20, 40, 60, 80, 100, 120, 160 A		
tIE> response delay	40, 80 ms		40, 80, 200, 300 ms
Accuracy	±5 % (0 – 630 A) ±10 % (>630 A)		
Indication	3 red LEDs: Short circuit: 2 or 3 phases (L1, L2, L3)	3 red LEDs: Short circuit: 2 or 3 phases (L1, L2, L3)	3 red LEDs: Short circuit: 2 or 3 phases (L1, L2, L3)
Reset	<ul style="list-style-type: none"> ▶ By button ▶ Automatic time reset: 1,2, 4 or 8 h 		<ul style="list-style-type: none"> ▶ By button ▶ Automatic time reset: 2, 4, 8 or 24 h ▶ Auxiliary voltage supply
Power supply	<ul style="list-style-type: none"> CT powered Internal power supply External auxiliary supply 		
	<ul style="list-style-type: none"> Back-up capacitor: max. 8 hours after loss of auxiliary power 24 – 230 V AC/DC 		
Remote signalling / Communication	Radio frequency: 868 MHz with LoRaWAN protocol		
Housing	Polycarbonate, Front IP40, Terminals IP20		
Temperature range	-30 °C to +70 °C		

Equipment set	Page	Order no.	Accessories	Page
1 Display unit			Wall-mounted housing	58
Sigma L		37-1321-101	Disassembly clip	59
Sigma F+E L		37-2321-101	Spring clip	59
Sigma F+E 3 L		37-5323-101		
Antenna (required for all three device variants)		28-7910-018		
3 Single-phase current sensors	50			

Dimension drawing see on page 132 ff | M3

ComPass A

Short-circuit and earth fault indicator



ComPass A

PRODUCT FEATURES

- ▶ Short-circuit and earth fault detection by 3 Single-phase current sensors
- ▶ LED and OLED display: for good visibility
- ▶ Monitoring of current (I) and frequency (f)
- ▶ Remote indication via RS485 / Modbus interface and 4 freely configurable relay contacts

YOUR ADVANTAGES

- ▶ Network load visible on site
- ▶ Remote signalling of analogue values

The ComPass A device is a combined short-circuit and earth fault indicator for medium voltage distribution networks with solidly or low-impedance earthed neutral system.

The device indicates all measuring results and parameter settings on a menu-controlled display. Via Modbus protocol the device can be parameterised and reports the fault events.

When the previously set trip values are exceeded, the red LED will start flashing. By operating the rocker switch short-circuits or earth faults will be displayed in plain text format. The device saves the last 20 events along with date, time, and information on fault currents.

Technical data	ComPass A
Short-circuit indicator	■
Earth fault indicator	■
Earth fault detection method	Earth short-circuit
Measured values / indication	<ul style="list-style-type: none"> ▶ Phase currents I_1, I_2, I_3, I_E with phase angle ▶ Operating current, $I_1, I_2, I_3, I_E \varnothing 15 \text{ min}$, $I_1, I_2, I_3 \text{ max. } 24 \text{ h} / 7 \text{ days} / 365 \text{ days}$ ▶ Maximum demand indicator $I \text{ max. LR (last reset)}$ I_1, I_2, I_3 ▶ Frequency f
$I_{>>}$ short-circuit trip current	10–2,000 A (1-A-steps)
$t_{I>>}$ response delay	40 ms–60 s (10-ms-steps)
$I_{E>}$ earth fault trip current	20–1,000 A (low impedance / rigidly earthed network)
$t_{I_{E>}}$ response delay	40 ms–60 s
Measurement accuracy phase currents	<ul style="list-style-type: none"> ±3 % (0–630 A, resolution 1 A) ±5 % (630–1,500 A) ±10 % (1,500–2,000 A)
Indication	LED status display (multicolour) OLED display (multicolour)
Remote signal / communication	4 potential-free relay contacts, freely configurable RS485 / Modbus interface
Remote contact	4 potential-free permanent or momentary contacts (1 s), NC or NO Contact capacity: 230 V AC / 1 A / 62.5 VA max.; 220 V DC / 1 A / 60 W max.
Reset	<ul style="list-style-type: none"> ▶ By rocker switch ▶ Automatic time reset: 1 min–24 h ▶ Remote reset ▶ Via RS485 / Modbus interface ▶ Current restoration
Power supply	
External auxiliary supply	24 V–230 V AC / DC (±10 %)
Internal power supply	Long-life lithium cell, active flashing time >1,000 h, >1,000 display activations, shelf life ≥20 years
Housing	Polycarbonate, IP40
Temperature range	–30 °C to +70 °C

Equipment set	Page	Order no.	Accessories	Page
1 Display unit ComPass A		38-0102-001	Connection to remote monitoring	71
3 Single-phase current sensors	50		Wall-mounted housing	58
			External signal lamp	58
			Disassembly clip	59
			Spring clip	59

Dimension drawing see on page 132 ff | M3

ComPass A 2.0

Short-circuit and earth fault indicator



ComPass A 2.0

PRODUCT FEATURES

- ▶ Short-circuit and earth fault indicator suitable for two earth fault detection methods
- ▶ Short-circuit and earth fault detection from three single-phase current sensors
- ▶ LED and OLED display: for good visibility
- ▶ High-precision current measurement to 0.5 %
- ▶ Monitoring of current (I), temperature (T) and frequency (f)
- ▶ PT100 temperature sensor for equipment monitoring
- ▶ Limit monitoring: I, T
- ▶ Compass Explorer Software: Commissioning and parameterisation via front accessible USB port
- ▶ Pulse detection for resonant earthed networks

YOUR ADVANTAGES

- ▶ Fast commissioning and parameterisation
- ▶ Retrofit ready for earth and short-circuit indicators with fault direction, monitoring and control function

The ComPass A 2.0 is suitable for use in substations with a remote control connection of the electrical power distribution in a medium-voltage network. Trip current values and pre-fault current values are logged with time stamp.

In addition to the short-circuit and earth fault function, the ComPass A 2.0 measures the temperature, for example of a transformer or the transformer station with the PT100 sensor.

The ComPass A 2.0 provides the collected information, measured values and their limits, for transmission to the control room. Phase selectivity and type of faults (earth fault or short-circuit) are also shown in the OLED display.

Technical data	ComPass A 2.0
Short-circuit indicator	■
Earth fault indicator	■
Earth fault detection method	Earth short-circuit, Pulse detection
Measured values / indication	<ul style="list-style-type: none"> ▶ Operating current, I1, I2, I3, all average values adjustable (1–60 min), I1, I2, I3 max. 24 h / 7 days / 365 days, maximum demand indicator I_{max}. LR (last reset), T_{min}. LR, T_{max}. LR ▶ Frequency f ▶ Temperature T
I>> short-circuit trip current	10 – 2,000 A, Self-adjustment (200–2,000 A)
tI>> response delay	20 ms – 60 s
Iε> earth short-circuit trip current	10 – 1,000 A
tIε> response delay	40 ms – 60 s
ΔIε> Response values for pulse localisation (clock stroke)	1 – 200 A
Limit monitoring	
I> overload current	5–1,500 A; tI> response delay: 40 ms – 60 s
T</T<</T>/T>> temperature	–40 °C to +85 °C
Measurement accuracy phase currents	Up to 0.5 % / 0.5 A closed sensor type, ≤1 % / 0.5 A split-core sensor type
Indication	LED status display (multicolour) OLED display (multilingual)
Remote signal / communication	4 potential-free relay contacts, freely configurable RS485 / Modbus interface
Parameter setting	USB port with ComPass Explorer Software
Remote contact	4 potential-free permanent or momentary contacts, bistable, NC or NO Contact capacity: 230 V AC / 1 A / 62.5 VA max.; 220 V DC / 1 A / 60 W max.
Binary inputs	2, potential-free, 1 s < t < 5 s, freely programmable <ul style="list-style-type: none"> ▶ By rocker switch ▶ Automatic time reset: 1 min – 24 h ▶ Remote reset ▶ Via RS485 / Modbus interface ▶ Current restoration ▶ Restoration of auxiliary supply ▶ ComPass Explorer Software
Reset	
Power supply	
External auxiliary supply	24 – 230 V AC/DC (±10 %)
Internal power supply	Long-life lithium cell, active flashing time >1,000 h, >1,000 display activations, shelf life ≥20 years
Housing	Polycarbonate, IP50
Temperature range	–30 °C to +70 °C

Equipment set	Page	Order no.	Accessories	Page
1 Display unit ComPass A 2.0		38-0102-001	Connection to remote monitoring	71
3 Single-phase current sensors	50		Wall-mounted housing	58
			External signal lamp	58
			Disassembly clip	59
			Spring clip	59

Dimension drawing see on page 132 ff | M3

Accessories

for directional fault indicators Sigma and ComPass series

Voltage signal		
HR jack module	Gas-/solid insulated switchgear	Air-insulated switchgear
<div style="display: flex; justify-content: space-around;"> <div> <p>HR interface cable Page 54</p> </div> <div> <p>Wega with HR interface cable Page 93</p> </div> </div>	<p>Integrated voltage detecting system Wega series Page 84</p>	<div style="display: flex; justify-content: space-around;"> <div> <p>Interface cable Page 54</p> </div> <div> <p>Wega with interface cable Page 54</p> </div> </div>
+		
Current signal		
Split-core Single-phase current transformers for retrofit and new installations Page 50	Closed Single-phase current transformers for new installations Page 50	
+		
Directional short-circuit and earth fault indicators		
Sigma D series Page 38/39	ComPass B series/ ComPass D Page 42 - 47	
[+]		
Resistive voltage signal		
Optional supplement Page 56		

Project planning

for directional fault indicators Sigma and ComPass series

Company	<input type="text"/>	Contact partner	<input type="text"/>	Phone	<input type="text"/>
Project	<input type="text"/>				
Network informationen					
Operating voltage V _{Nom}	<input type="text"/>	kV	Neutral point treatment	<input type="text"/>	
Switchgear					
Manufacturer	<input type="text"/>	Type	<input type="text"/>	Year of construction	<input type="text"/>
			Panel name	<input type="text"/>	
<input type="checkbox"/> Gas-insulated/solid insulated <input type="checkbox"/> C1 capacity <input type="text"/> pF or panel type <input type="text"/>		<input type="checkbox"/> Air insulated <input type="checkbox"/> C1 capacity <input type="text"/> pF or sensor Type <input type="text"/>			
Cable length from panel to Wega <input type="text"/> m			Cable length from sensor to Wega <input type="text"/> m		
Capacity voltage signal					
System solution - Wega		System solution - Wega to HR interface		Direct connection - capacitive post insulator	
<input type="checkbox"/> Wega 1 <input type="checkbox"/> Wega 1 V <input type="checkbox"/> Wega 2 <input type="checkbox"/> Wega 2 V		<input type="checkbox"/> Wega 1 V <input type="checkbox"/> Wega 2 V		<input type="checkbox"/> Interface cable for capacitive post insulator	
Cable length between voltage signal and Sigma / ComPass <input type="text"/> m					
Resistive voltage signal					
<input type="checkbox"/> Yes					<input type="checkbox"/> No
Gas- / solid insulated switchgear			Air-insulated Switchgear		
<input type="checkbox"/> RDP1-24/RDP1-36 <input type="checkbox"/> RDP2-24/RDP2-36		<input type="checkbox"/> RDP3-24/RDP3-36 <input type="checkbox"/> RDP4-24		<input type="checkbox"/> RDP5-24/RDP5-36 <input type="checkbox"/> RDG3-24	
				<input type="checkbox"/> RDM3-24	
Directional fault indicator					
Monitoring and control function		Standard		Monitoring	
<input type="checkbox"/> ComPass Bs 2.0 / ComPass D		<input type="checkbox"/> Sigma D <input type="checkbox"/> Sigma D ⁺¹ <input type="checkbox"/> Sigma D ⁺⁺ <input type="checkbox"/> Sigma DM		<input type="checkbox"/> ComPass B <input type="checkbox"/> ComPass B 2.0	
Current signal					
<input type="checkbox"/> Single-phase current sensor for retrofit on insulated cables			<input type="checkbox"/> Single-phase current sensors for new installations on bushings		
Cable length between Sigma / ComPass and current signal <input type="text"/> m					
Your comments					
<input type="text"/>					

¹⁾ We recommend the use of an additional summation current sensor for the transient earth fault method.

Sigma D | Sigma D+ | Sigma D++

Short-circuit and earth fault direction indicator



Sigma D



Sigma D+



Sigma D++

PRODUCT FEATURES

- ▶ CT powered directional short-circuit and directional earth fault indicator for all distribution networks / neutral point treatments
- ▶ Earth fault detection with up to five different earth fault detection methods, also in combination
- ▶ Fully automatic voltage calibration
- ▶ Easy and flexible parameter setting via DIP switch or USB port
- ▶ Event memory for fault evaluation
- ▶ Multicolour LED status display
- ▶ Remote signalling via freely programmable relays
- ▶ Sigma Explorer Software: Commissioning and parameterisation via front accessible USB port

Special features of Sigma D+

- ▶ For the transient earth fault method with the Sigma D+ a summation current sensor is mandatory, auxiliary supply is optional.

Special features of Sigma D++

- ▶ Only 3 Single-phase current sensors needed for all earth fault detection methods
- ▶ Wide-range power supply 24 to 230 V AC/DC

For the transient earth fault method only three Single-phase current sensors are needed, but auxiliary supply is mandatory. The connection of a summation current sensor is optional. For all other fault detection methods, no auxiliary power is required if the operating current is >5 A.

YOUR ADVANTAGES

- ▶ Immediate detection of fault direction
- ▶ No auxiliary supply required (Sigma D & D+)
- ▶ Fast commissioning and parameterisation
- ▶ Monitoring on site with USB port and Sigma Explorer

The Sigma D series are combined directional short-circuit and directional earth fault indicators for medium voltage distribution networks. The devices are current sensor powered. The voltage information will be taken from an integrated voltage detecting system (Wega series), from an HR interface or capacitive post insulators.

The Sigma D+ and Sigma D++ provide additional earth fault detection methods for compensated and isolated neutral networks.

The variants differ in regard of the transient earth fault method.

Technical data	Sigma D	Sigma D+	Sigma D++
Directional short-circuit indicator	■	■	■
Directional earth fault indicator	■	■	■
Earth fault detection methods	Earth short-circuit	Continuous earth fault, earth short circuit, cos φ and sin φ method, pulse detection, transient earth fault	
I>> short-circuit trip current	▶ DIP: 200, 300, 400, 600, 800, 2,000 A, Self-adjustment (200–2,000 A) ▶ SW: 50–2,000 A (1-A-steps)		
tI>> response delay	DIP: 40, 80 ms; SW: 40 ms–60 s		
IE> earth fault trip current	DIP: off, 20, 40, 60, 80, 100, 120, 160 A; SW: 10–1,000 A (1-A-steps)		
tIE> response delay	DIP: 80, 160 ms; SW: 40 ms–60 s		
IE> Transient method, trip current	–	10–100 A	10–500 A
IEP> Active current cos φ trip current	–	2–200 A	–
tIEP> response delay	–	2–200 A	–
IEQ> Reactive current sin φ trip current	–	40 ms–60 s	–
tIEQ> response delay	–	1–100 A	–
Measurement accuracy phase currents	3 % (0–630 A, resolution 1 A) 5 % (630–1,500 A) 10 % (1,500–2,000 A)		
Indication	▶ 3 red LEDs phase-selective L1, L2, L3 ▶ 1 red LED short-circuit I>> ▶ 1 yellow LED earth short-circuit IE> ▶ LED, fault direction arrows red / green		
Remote signal / communication	4 potential-free relay contacts, freely configurable		
Parameterisation	▶ USB 2.0 interface, connection to Sigma Explorer Software ▶ Via DIP switches on the device		
Remote contact	4 Potential-free permanent or momentary contacts (1 s), NC or NO Contact capacity: 230 V AC / 1 A / 62,5 VA max.; 220 V DC / 1 A / 60 W max.		
Voltage calibration	Manual / automatic ▶ By button ▶ Remote reset ▶ Automatic time reset: DIP: 2, 4, 8, 24 h; SW: 1 min–24 h ▶ Current restoration ▶ Voltage restoration		
Reset			
Power supply			
CT powered	■	■	■
Internal power supply	Long-life lithium cell, shelf life ≥20 years		
External auxiliary supply	–	Optional: 24-60V DC 24V AC	24–230 V AC/DC (optional) required for transient method
Summation current sensor	–	Required for transient method	Optional
Housing	Polycarbonate, IP40		
Temperature range	–30 °C to +70 °C		

Equipment set	Page	Order no.	Accessories	Page
1 Display unit Sigma D		37-6000-001	Installation system	59
3 Single-phase current sensors	50		Connection to remote monitoring	71
1 Voltage signal	54		Wall-mounted housing	58
Equipment set	Page	Order no.	External signal lamp	58
1 Display unit Sigma D+		37-6100-001	Disassembly clip	59
3 Single-phase current sensors	50		Spring clip	59
1 Summation current sensor (required for transient method)	51			
1 Voltage signal	54			
Equipment set	Page	Order no.		
1 Display unit Sigma D++		37-6200-001		
3 Single-phase current sensors ¹⁾	50			
1 Voltage signal	54			

¹⁾ Combination with summation current sensor possible: 2+1
Project planning on page 37

Dimension drawing see on page 132 ff | M3

Sigma DM

Short-circuit and earth fault direction indicator

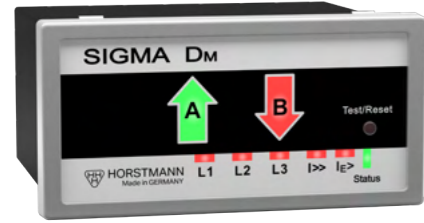

Sigma DM

PRODUCT FEATURES

- ▶ Short-circuit and earth fault direction indicators for all networks and neutral point treatments
- ▶ Remote signalling via RS485 with Modbus RTU
- ▶ Requires only three phase current sensors for all earth fault location methods
- ▶ Earth fault detection with up to six different earth fault detection methods, can also be combined
- ▶ Independent, fully automatic voltage calibration
- ▶ Simple and flexible parameterisation via DIP switch or USB port
- ▶ Event memory for error evaluation
- ▶ LED status display, multicolour
- ▶ Sigma Explorer software: Commissioning, parameterisation and reading out the event memory via the front USB port
- ▶ Wide-range power supply 24 V to 230 V AC/DC

YOUR ADVANTAGES

- ▶ Immediate fault direction detection
- ▶ Availability of measured values and error messages in the control room via RS485/Modbus RTU and on site via USB port with Sigma Explorer software
- ▶ Fast commissioning and parameterisation

The Sigma DM is a directional short-circuit and earth fault indicator with clear fault direction indication. Equipped with an RS485 interface for transmitting measured values and error messages via the Modbus RTU protocol.

Suitable closed current sensors are available for every gas- and solid-insulated medium-voltage system for installation via the cone in the cable panels. It is also possible to retrofit divisible current sensors around the medium-voltage cable, even in air-insulated systems. The phase voltage and the reference signal for fault direction indication are provided via the voltage detecting system Wega. The voltage signal is automatically adjusted to the switchgear over 24 hours or can be adjusted manually using buttons or the Sigma Explorer configuration software. Operational readiness is indicated by the status LED.

Sigma DM provides 6 earth fault location detection for all neutral point treatments such as resonant earthing, isolated neutral point, low-resistance or temporarily low-resistance earthing, which can also be used in combination. Earth fault detection methods such as pulse detection are supported. Two digital inputs are freely configurable and, in addition to the test/reset function, can also detect status information such as switch positions.

Except for the transient earth fault method, no auxiliary voltage is required for fault detection if the load current is >5 A.

Technical data	Sigma DM
Short-circuit indicator	■
Earth fault indicator	■
Earth fault detection method	Continuous earth fault, earth short circuit, $\cos \varphi$ and $\sin \varphi$ method, pulse detection, transient earth fault
Measured values	<ul style="list-style-type: none"> ▶ Phase currents I1, I2, I3, IE with phase angle ▶ Phase-to-earth voltage V1, V2, V3, VNE and phase-to-phase voltage V12, V23, V31, VNE ▶ Power P, Q, S and power factor $\cos \varphi$ (P1,2,3, Q1,2,3, S1,2,3, $\cos \varphi$1,2,3) ▶ Network frequency f
Indication	<ul style="list-style-type: none"> ▶ 3 red LEDs phase-selective L1, L2, L3 ▶ 1 red LED short-circuit I>> ▶ 1 yellow LED earth short-circuit IE> ▶ LED, fault direction arrows red / green
I>> short-circuit trip current	DIP: 400, 800, 1,000, 2,000 A, Self-adjustment SW: 10 - 2,000 A
tI>> Response delay	50 – 2,000 A
IE> earth fault trip current	10 - 1,000 A
tIE> response delay	40 ms – 60 s DIP: On/Off
IEQ> Reactive current $\sin \varphi$ trip current	1 – 200 A tIEP> / tIQP> Response delay: 40 ms – 60 s
VNE> Response values continuous earth fault	0 – 100 % tVNE> Response delay: 40 ms – 60 s
V> Overvoltage trip values	100 % – 200 %
V< Undervoltage trip values	0 % – 100 %
Measurement accuracy phase currents	3 % (0 – 630 A, resolution 1 A) 5 % (630 – 1,500 A) 10 % (1,500 – 2,000 A)
Remote signal / communication	RS485- / Modbus interface
Reset	<ul style="list-style-type: none"> ▶ Remote reset ▶ Automatic time reset: 1 min - 24 h ▶ Via RS485 / Modbus interface ▶ Power recovery ▶ Voltage recovery ▶ Auxiliary voltage recovery
Power supply	
Internal power supply	24 - 230 V AC/DC (for IET> RS485/Modbus RTU)
External auxiliary supply	Long-life lithium cell, >1,000 h total flashing time of the LED, >1,000 activations of the display
Housing	Polycarbonate, IP40
Temperature range	-30 °C to +70 °C

Equipment set	Page	Order no.	Accessories	Page
1 Display unit Sigma DM		37-6250-001	Connection to remote monitoring	71
3 Single-phase current sensors	50		Wall-mounted housing	58
Voltage coupling	54		Disassembly clip	59
			Spring clip	59

Dimension drawing see on page 132 ff | M3

ComPass B

Directional fault indicator with monitoring



ComPass B

PRODUCT FEATURES

- ▶ Directional short-circuit and earth fault detection for all distribution networks / neutral point treatments
- ▶ LED and OLED display: for good visibility
- ▶ Monitoring of V, I, f
- ▶ Load monitoring and load flow direction monitoring P, Q, S, cos φ, E
- ▶ Voltage monitoring V<, V>
- ▶ Active energy to load flow direction A↑ or B↓
- ▶ Multilingual OLED display, additional multicolour LED
- ▶ Remote indication using RS485 / Modbus interface and four freely configurable relay contacts
- ▶ User friendly, simple and intuitive operation, easy-to-read display

YOUR ADVANTAGES

- ▶ Fast fault location determination
- ▶ Immediate detection of voltage limit violations
- ▶ Measured values available for control room and on site

The ComPass B combines the functions of a directional short-circuit and directional earth fault indicator in one unit for medium voltage distribution networks. The voltage information will be taken from the integrated voltage detecting system, either Wega 1, Wega 2, Wega 1 V or Wega 2 V. Optional the voltage information can be taken from the HR interface or capacitive post insulators.

Technical data	ComPass B
Short-circuit indicator	■
Earth fault indicator	■
Earth fault detection method	Earth short-circuit, cos φ, sin φ, pulse detection, transient earth fault
Measured values / indication	<ul style="list-style-type: none"> ▶ Phase currents I1, I2, I3, IE with phase angle ▶ Phase-to-earth voltage V1, V2, V3, VNE and phase-to-phase voltage V12, V23, V31, VNE ▶ Load flow direction A↑ or B↓ ▶ S, P, Q and cos φ (S 1,2,3, P 1,2,3, Q 1,2,3, cos φ 1,2,3) ▶ Effective energy (E1A, E2A, E3A, EA, E1B, E2B, E3B, EB) ▶ Operating current, I1, I2, I3, IE ø15 min, I1, I2, I3 max. 24 h / 7 days / 365 days ▶ Maximum demand indicator I max. LR (last reset) I1, I2, I3 ▶ Frequency f
I>> short-circuit trip current	50–2,000 A
tI>> response delay	40 ms–60 s
tIE> earth fault trip current	20–1,000 A (low-impedance / solidly earthed network) 5–200 A (isolated / compensated network)
tIE> response delay	40 ms–60 s
IEP> active current cos φ / IEQ> reactive current sin φ	1–200 A tIEP> / tIEQ> response delay: 40 ms–60 s
VNE> permanent earth fault values	0–100 % tVNE> response delay: 40 ms–60 s
V> Overvoltage trip values	100 %–200 %
V< Undervoltage trip values	0 %–100 %
Measurement accuracy phase currents	3 % (0–630 A, resolution 1 A) 5 % (630–1,500 A) 10 % (1,500–2,000 A)
Indication	LED status display (multicolour) OLED display (multicolour)
Remote signal / communication	4 potential-free relay contacts, freely configurable RS485 / Modbus interface
Remote contact	4 potential-free permanent or momentary contacts (1 s), NC or NO Contact capacity: 230 V AC / 1 A / 62.5 VA max.; 220 V DC / 1 A / 60 W max.
Reset	<ul style="list-style-type: none"> ▶ By rocker switch ▶ Remote reset ▶ Automatic time reset: 1 min–24 h ▶ Via RS485 / Modbus interface ▶ Current restoration ▶ Voltage restoration ▶ Restoration of auxiliary supply
Power supply	
External auxiliary supply	24 V–230 V AC / DC (±10 %)
Internal power supply	Long-life lithium cell, active flashing time >1,000 h, >1,000 display activations, shelf life ≥20 years
Housing	Polycarbonate, IP40
Temperature range	–30 °C to +70 °C

Equipment set	Page	Order no.	Accessories	Page
1 Display unit ComPass B		38-4102-001	Installation system	59
3 Single-phase current sensors	50		Connection to remote monitoring	71
1 Voltage signal	54		Wall-mounted housing	58
			External signal lamp	58
			Disassembly clip	59
			Spring clip	59

Dimension drawing see on page 132 ff | M3

ComPass B 2.0 | ComPass Bs 2.0

Directional fault indicator with monitoring and control function



ComPass B 2.0



ComPass Bs 2.0

PRODUCT FEATURES

- ▶ Clear fault indication and reading on-site: 2 directional arrow LEDs (A, B) and high contrast OLED display
- ▶ High-precision current and voltage measurement to 0.5 %
- ▶ Monitoring of the parameters voltage (V), current (I), load flow direction (A↑ or B↓), power factor (cos φ), power (P, Q, S), energy (E), temperature (T) and frequency (f)
- ▶ Suitable for all types of networks/neutral point treatments
- ▶ Earth fault detection with 6 different earth fault detection methods, also in combination
- ▶ Voltage monitoring with connection to capacitive and resistive (ohmic) sensors in one indicator
- ▶ Limit monitoring: V, I, P, Q, T
- ▶ ComPass Explorer Software: Commissioning and parameterisation via front accessible USB port

Additional features of the Control ComPass BS 2.0:

- ▶ Control ComPass Bs 2.0 for remote controlling of a load-break switch or circuit-breaker
- ▶ Free assignment of six binary inputs for the collection and transmission of relevant switchgear / station data
- ▶ Freely programmable logic for flexible definition of switchgear conditions

YOUR ADVANTAGES

- ▶ Immediate detection of fault direction
- ▶ Immediate detection of limit violations
- ▶ Measured values available on site and for SCADA
- ▶ Only ComPass BS: Remote switching
- ▶ Automatic self-calibration of the capacitive voltage inputs, optionally with temperature compensation

The ComPass B 2.0 is suitable for use in substations with a remote control connection of the electrical power distribution in a medium voltage network. In addition to the short-circuit and earth fault function, ComPass B 2.0 supplies the collected measured values of current, voltage and power from the station for transmission to the control room. The PT-100 sensor measures the temperature of the transformer or the transformer station. For all measured values limits can be defined, which can also be transmitted to the control room.

The voltage coupling/measurement is done via the capacitive VDIS* system and/or via resistive (ohmic) voltage sensors. With the simultaneous measurement, the voltage measurement of the VDIS system can be automatically calibrated with the resistive voltage measurement. Up to four ComPass B can be connected to one set of resistive voltage sensors.

In addition to the functions of the ComPass B 2.0, the ComPass Bs 2.0 offers a control function for switching a load-break switch or circuit-breaker. A free assignment of six binary inputs in combination with a freely programmable logic (PLC functionality) enables the user to define the switching conditions in a flexible manner. Random information, such as the SF6 gas disruption or HV tripped fuse, can be captured via the binary inputs.

* VDIS according to IEC62271-213, current standard as of 08/2023

Technical data	ComPass B 2.0	ComPass Bs 2.0
Short-circuit indicator	■	■
Earth fault indicator	■	■
Earth fault detection method	Permanent, earth short-circuit, transient, cos φ, sin φ, Pulse location	
Remote control	-	2 Switching elements
Control system /freely programmable logic	-	■
Measured values / indication	<ul style="list-style-type: none"> ▶ Phase currents I₁, I₂, I₃, I_E with phase angle ▶ Phase-to-earth voltage V₁, V₂, V₃, V_{NE} and phase-to-phase voltage V₁₂, V₂₃, V₃₁, V_{NE} with phase angle ▶ Load flow direction A↑ or B↓ ▶ P, Q, S and cos φ (power factor) (P_{1,2,3}, Q_{1,2,3}, S_{1,2,3}, cos φ_{1,2,3} via RS485) ▶ Amount of active energy, separate for load flow direction A↑ or B↓, additionally per phase ▶ Operating current, I₁, I₂, I₃, I_E, S, P, Q, V₁₂, V₂₃, V₃₁, all average values adjustable (1–60 min), I₁, I₂, I₃ max. 24 h / 7 days / 365 days, maximum demand indicator I_{max}. LR, V_{12max}. LR, V_{23max}. LR, V_{31max}. LR, S_{max}. LR, P_{max}. LR, Q_{max}. LR, T_{min} LR, T_{max}. LR (last reset) ▶ Power frequency f ▶ Temperature T 	
I>> short-circuit trip current	10 – 2,000 A, Self-adjustment (200–2,000 A)	tI>> response delay: 40 ms–60 s
IES> / IES>> earth short-circuit trip current	10 – 1,000 A	tIES> / tIES>> Response delay: 40 ms–60 s
IET> transient method	1 – 500 A	
IEP> active current cos φ	1 – 200 A	tIEP> / tIEQ> Response delay: 40 ms–60 s
IEQ> reactive current sin φ	1 – 200 A	
VNE> permanent earth fault values	1–100 %	tVNE> Response delay: 40 ms–60 s
Limit monitoring		
I> overload current	5–1,500 A	tI> Response delay: 40 ms–60 s
V> overvoltage	100–200 %	tV> Response delay: 40 ms–60 s
V< undervoltage	1–100 %	tV< Response delay: 40 ms–60 s
P> / P>> / +P> / -P> active power	1–30,000 kW	tP> / tP>> / +tP> / -tP> Response delay: 40 ms–60 s
Q> / Q>> / +Q> / -Q> reactive power	1–30,000 kW	tQ> / tQ>> / +tQ> / -tQ> Response delay: 40 ms–60 s
T< / T<< / T> / T>> temperature	-40 °C to +85 °C	
Measurement accuracy phase currents	Up to 0.5 % / 0.5 A closed sensor type, 1 % / 0.5 A split-core sensor type	
Measurement accuracy voltages	Up to 0.5 % in the range of 80–120 % / V _{nom} (resistive)	
Indication	<ul style="list-style-type: none"> ▶ LED status display (multicolour) ▶ OLED display (multicolour) 	
Remote signal / communication	<ul style="list-style-type: none"> ▶ 4 potential-free relay contacts, freely configurable ▶ RS485 / Modbus interface 	
Parameter setting	USB port with ComPass Explorer Software	
Remote contact	4 permanent or momentary contacts, bistable, NC or NO Contact capacity: 230 V AC / 1 A / 62.5 VA max.; 220 V DC / 1 A / 60 W max.	4 permanent or momentary contacts, monostable, NC or NO Contact capacity: 250 V AC / 6 A; 30 V DC / 6 A, resistive load
Binary inputs	2, potential-free, 1 s < t < 5 s, freely programmable	6, freely programmable, max. 30 V DC
Reset	<ul style="list-style-type: none"> ▶ By rocker switch ▶ Remote reset ▶ Automatic time reset: 1 min–24 h ▶ Via RS485 / Modbus interface ▶ Current restoration ▶ Voltage restoration ▶ Restoration of auxiliary supply ▶ ComPass Explorer Software 	
Power supply		
External auxiliary supply	24–230 V AC/DC (±10 %)	
Internal Power supply	Long-life lithium cell, active flashing time >1,000 h, >1,000 display activations	
Housing	Polycarbonate, IP50	
Temperature range	-30 °C to +70 °C	

Equipment set	Page	Order no.	Accessories	Page
1 Display unit			Installation system	59
ComPass B 2.0		38-4150-001	Connection to remote monitoring	71
ComPass Bs 2.0		38-4153-001	Temperature sensor PT100	59
3 Single-phase current sensors ¹⁾	50		Wall-mounted housing	58
1 Voltage signal	54		External signal lamp	58
			Disassembly clip	59
			Spring clip	59

¹⁾ Combination with summation current sensor possible: 2+1 or 3+1
Project planning on page 37, Product matrix on page 10-14

ComPass D

Directional fault indicator with monitoring and control function via IEC 60870-5-104



ComPass D

PRODUCT FEATURES

- ▶ Remote control option for 2 switching elements
- ▶ Communication via Ethernet with IEC 60870-5-104 protocol
- ▶ Clear fault indication and reading on-site: 2 directional arrow LEDs (A, B) and high contrast OLED display
- ▶ High-precision current and voltage measurement to 0.5 %
- ▶ Monitoring of the parameters voltage (V), current (I), load flow direction (A↑ or B↓), power factor (cos φ), power (P, Q, S), energy (E), temperature (T) and frequency (f)
- ▶ Suitable for all types of networks/neutral point treatments
- ▶ Earth fault detection with 6 different earth fault detection methods, also in combination
- ▶ Voltage monitoring with connection to capacitive and resistive (ohmic) sensors in one indicator
- ▶ Limit monitoring: V, I, P, Q, T
- ▶ Commissioning via USB connection with support for ComPass Explorer and ScadaDataConfigurator software
- ▶ Freely assignable binary inputs for recording and transmitting relevant status information from the system/station
- ▶ Freely programmable logic for defining the switching conditions

YOUR ADVANTAGES

- ▶ Fast fault direction detection
- ▶ High-precision current and voltage monitoring
- ▶ Detection of threshold violations
- ▶ Availability of measured values in the control room and on-site
- ▶ Remotely controllable from the control room via IEC 60870-5-104 protocol
- ▶ Automatic self-calibration of capacitive voltage inputs, optionally with temperature compensation

The ComPass D is suitable for use in substations with a remote control connection of the electrical power distribution in a medium voltage network. In addition to the short-circuit and earth fault functions, the ComPass D collects highly accurate measured values for current, voltage and power from the substation and makes them available for transmission to the control room. The PT-100 sensor measures the temperature, for example of the transformer or the transformer station. For all measured values limits can be defined, which can also be transmitted to the control room.

The voltage coupling/measurement is done via the capacitive VDIS* system and/or via resistive (ohmic) voltage sensors. Up to five ComPass D can be connected to a set of resistive voltage sensors.

The ComPass D offers a control function for switching a load-break switch or circuit-breaker. A free assignment of six binary inputs in combination with a freely programmable logic (PLC functionality) enables the user to define the switching conditions in a flexible manner. Random information, such as the SF6 gas disruption or HV tripped fuse, can be captured via the binary inputs.

* VDIS according to IEC62271-213, current standard as of 08/2023

Technical data	ComPass D	
Short-circuit indicator	■	
Earth fault indicator	■	
Earth fault detection method	Permanent, earth short-circuit, transient, cos φ, sin φ, Pulse location	
Measured values / indication	<ul style="list-style-type: none"> ▶ Phase currents I₁, I₂, I₃, I_E with phase angle ▶ Phase-to-earth voltage V₁, V₂, V₃, V_{NE} and phase-to-phase voltage V₁₂, V₂₃, V₃₁, V_{NE} with phase angle ▶ Load flow direction A↑ or B↓ ▶ P, Q, S and cos φ (power factor) (P_{1,2,3}, Q_{1,2,3}, S_{1,2,3}, cos φ_{1,2,3} via RS485) ▶ Amount of active energy, separate for load flow direction A↑ or B↓, additionally per phase ▶ Operating current, I₁, I₂, I₃, I_E, S, P, Q, U₁₂, U₂₃, U₃₁, all average values adjustable (1–60 min), I₁, I₂, I₃ max. 24 h / 7 days / 365 days, maximum demand indicator I_{max} LR, V_{12max} LR, V_{23max} LR, V_{31max} LR, S_{max} LR, P_{max} LR, Q_{max} LR, T_{min} LR, T_{max} LR (last reset) ▶ Power frequency f ▶ Temperature T 	
I>> short-circuit trip current	DIP: 400, 800, 1,000, 2,000 A, Self-adjustment: 10 - 2,000 A	
IES> / IES>> earth short-circuit trip current	10 – 1,000 A	tIES> / tIES>> Response delay: 40 ms – 60 s
IET> transient method	10 – 500 A	
IEP> active current cos φ	– 200 A tIEP> / tIEQ> Response delay: 40 ms – 60 s	
I EQ> reactive current sin φ	1 – 200 A	
VNE> permanent earth fault values	1–100 %	tVNE> Response delay: 40 ms – 60 s
Limit monitoring		
I> overload current	5–1.500 A	tI> Response delay: 40 ms – 60 s
V> overvoltage	100–200 %	tV> Response delay: 40 ms – 60 s
V< undervoltage	1–100 %	tV< Response delay: 40 ms – 60 s
P> / P>> / +P> / -P> active power	1–30,000 kW	tP> / tP>> / +tP> / -tP> Response delay: 40 ms – 60 s
Q> / Q>> / +Q> / -Q> reactive power	1–30,000 kW	tQ> / tQ>> / +tQ> / -tQ> Response delay: 40 ms – 60 s
T< / T<< / T> / T>> temperature	–40 °C to +85 °C	
Measurement accuracy phase currents	Up to 0.5 % / 0.5 A closed sensor type, 1 % / 0.5 A split-core sensor type	
Measurement accuracy voltages	Up to 0.5 % in the range of 80–120 % / V _{nom} (resistive)	
Indication	<ul style="list-style-type: none"> ▶ LED status display (multicolour) ▶ OLED display (multicolour) 	
Remote signal / communication	<ul style="list-style-type: none"> ▶ 4 potential-free relay contacts, freely configurable ▶ Ethernet / IEC 607-5-104 	
Parameter setting	USB port with ComPass Explorer Software	
Remote contact	4 permanent or momentary contacts, bistable, NC or NO Contact capacity: 250 V AC/6 A; 30 V DC/6 A	
Binary inputs	6, freely programmable, max. 30 V DC	
Reset	<ul style="list-style-type: none"> ▶ By rocker switch ▶ Remote reset ▶ Automatic time reset: 1 min – 24 h ▶ Via Ethernet with IEC 60870-5-104 protocol ▶ Current restoration ▶ Voltage restoration ▶ Restoration of auxiliary supply ▶ ComPass Explorer Software 	
Power supply		
External auxiliary supply	24 V AC/DC	
Internal Power supply	Long-life lithium cell, service lifetime ≥20 years, >900 h total flashing time	
Housing	Polycarbonate, IP50	
Temperature range	–30 °C to +70 °C	

Equipment set	Page	Order no.	Accessories	Page
1 Display unit			Installation system	59
ComPass D		38-5110-201	Connection to remote monitoring	71
3 Single-phase current sensors ¹⁾	50		Wall-mounted housing	58
1 Voltage signal	54		External signal lamp	58
			Disassembly clip	59
			Spring clip	59

¹⁾ Combination with summation current sensor possible: 2+1 or 3+1
Project planning on page 37, Product matrix on page 10-14

Dimension drawing see on page 132 ff | M3

Phase current transformers

For installation on bushings and pole plates

for Alpha M, Alpha E



ABB
SafeRing, SafeLink, RGC,
SafePlus
Order no.
3 x 49-6012-009



ABB
SafeRing, RGC,
SafePlus
Order no.
1 x 49-6012-015



Driescher
MINEX, G.I.S.E.L.A.
Order no.
3 x 49-6012-007



EATON/Holec
SVS
Order no.
1 x 49-6010-032



EATON/Holec
XIRIA
Order no.
1 x 49-6010-048



Ormazabal
GA / GAE, GE
Order no.
3 x 49-6010-011



Schneider Electric
RM6
Order no.
3 x 49-6010-044



Schneider Electric
FBA, GLA, GMA
Order no.
3 x 49-6010-030



Schneider Electric
FBX
Order no.
3 x 49-6012-005



Siemens
8DJ, 8DH, SIMOSEC
Order no.
3 x 49-6010-052



Siemens
8DJH module transformer
Order no.
3 x 49-6010-060

For installation on insulated cables

for Alpha M, Alpha E



Conductor Ø [mm]	Cable length [m]	Order no.
15 – 52	3.00	49-6011-040
15 – 52	6.00	49-6011-043

For installation on cables and busbars

for Opto F 3.0, Opto F+E 3.0



Trip currents ¹⁾ [A]	Conductor Ø [mm]	Order no.
400, 600, 800 or 1,000	22 – 42	49-0101-202

¹⁾ adjustable



Trip currents ¹⁾ [A]	Conductor Ø [mm]	Order no.
400, 600, 800 or 1,000	40 – 60	49-0101-203

¹⁾ adjustable



Trip currents ¹⁾ [A]	Conductor Ø [mm]	Order no.
400, 600, 800 or 1,000	20 x 4 – 40 x 10	49-0101-206

¹⁾ adjustable

Single-phase current sensors

For new installations on bushing with Ø 84 mm for Sigma 2.0 series, Sigma D series ComPass series

	<p>ABB SafeLink, SafePlus, SafeRing Order no. 3 x 49-6025-000 Ø 79,5 mm 3 x 49-6025-301 Ø 84 mm</p>		<p>Schneider Electric RM6, RMAirSet Order no. 3 x 49-6025-615</p>
	<p>Driescher MINEX, MINEX C, G.I.S.E.L.A Order no. 3 x 49-6025-601¹⁾</p>		<p>Schneider Electric FBX Order no. 1 x 49-6025-622</p>
	<p>EATON XIRIA Order no. 3 x 49-6025-000 Ø 79,5 mm 3 x 49-6025-301 Ø 84 mm</p>		<p>Siemens 8DJH24 (module transformer), Field width 310 mm Order no. 1 x 49-6025-630</p>
	<p>Lucy Electrics AegisPlus Order no. 3 x 49-6025-601</p>		<p>Siemens 8DJH24, 8DJH36, NX-Plus C Field width 430 mm Order no. 3 x 49-6025-611</p>
	<p>Ormazabal GA/GAE + GE Order no. 3 x 49-6025-311</p>		

For screened connectors only. Insulation level: 0.72 / 3 kV.
¹⁾ Without retaining plates. Order no. with retaining plates on request

For mounting on bushings for SF6-free compact switchgears for Sigma 2.0 series, Sigma D series

	<p>Siemens 8DJH24 blueGIS (module transformer) Order no. 49-6025-630</p>		<p>ABB SafePlus Air/AirPlus 12/24kV Order no. 3 x 49-6025-301</p>
	<p>Schneider Electric RM AirSeT24 Order no. 49-6025-623</p>		<p>Ormazabal cgm.zero24 Order no. 3 x 49-6025-316</p>

Single-phase current sensors | Summation current sensor

CSOR | For installation on insulated conductors up to 12kV/√3 for Sigma 2.0 series, Sigma D series, ComPass series



Conductor Ø [mm]	Cable length [m]	Order no.
15–45	3.00	V49-6024-010-042

For installation on insulated cables for retrofitting for Sigma 2.0 series, Sigma D series, ComPass series



Conductor Ø [mm]	Cable length [m]	Order no.
15–55	3.00	49-6024-001



Conductor Ø [mm]	Cable length [m]	Order no.
15–65	3.00	49-6024-010
15–78 (for 1,250 A)	3.00	49-6024-130

For installation on shielded and earthed medium-voltage cables for Earth 4.0, Earth Zero, Earth Zero Flag



Conductor Ø [mm]	Cable length [m]	Order no.
up to 130 mm	3,00	49-6013-029

For installation on insulated medium-voltage cables for Opto F+E 3.0

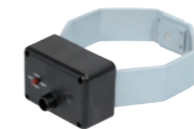

Trip currents ¹⁾ [A]	Conductor Ø [mm]	Order no.
(10), (20), 40 or 80	up to 115	49-6014-007
40, 80, 120 or 160	up to 115	49-6014-009

Summation current sensor

Summation current sensor, splittable for Sigma D+, Sigma D++, ComPass B series



Conductor Ø [mm]	Cable length [m]	Order no.
220–250	4,00	49-6023-020

Product matrix

Capacitive and resistive voltage signal



Function	C1A2-24	C11x	RDP series	RDG3-24	RDM3-24
Capacitive voltage signal	■	■	—	—	—
Resistive voltage signal	—	—	■	■	■
Voltage indication	—	—	—	—	—
Voltage measurement	—	—	■	■	■
Connection					
Connection to Sigma D series	■	■	—	—	—
Connection to ComPass B	■	■	—	—	—
Connection to ComPass B 2.0 series	■	■	■	■	■
Purpose					
New installation	—	■	■	■	■
Retrofit	■	■	■	■	■
Gas- / solid insulated switchgear	—	—	■	■	—
Air-insulated switchgear	■	■	—	—	■
Features					
Maintenance-free voltage detecting system	—	—	—	—	—
Relay contacts for remote monitoring	—	—	—	—	—
Voltage indication in combination with HR interface	—	—	—	—	—
Voltage indication in combination with post insulator	—	—	—	—	—
Direct connection from HR interface to directional fault indicator	—	—	—	—	—
Direct connection from post insulator to directional fault indicator	—	—	—	—	—
Capacitive interface integrated in switchgear	—	—	—	—	—
High-precision voltage measurement	—	—	■	■	■
Installation on T connector set	—	—	■	—	—
Installation on A cone	—	—	—	■	—
Connection to Wega possible	■	■	—	—	—
Voltage calibration necessary	■	■	—	—	—

Product matrix

Capacitive and resistive voltage signal



Function	Wega with interface cable	Interface cable for post insulator
Capacitive voltage signal	■	■
Resistive voltage signal	—	—
Voltage indication	■	—
Voltage measurement	—	■
Connection		
Connection to Sigma D series	■	■
Connection to ComPass B	■	■
Connection to ComPass B 2.0 series	■	■
Purpose		
New installation	—	—
Retrofit	■	■
Gas- / solid insulated switchgear	■	—
Air-insulated switchgear	■	■
Features		
Maintenance-free voltage detecting system	■	—
Relay contacts for remote monitoring	—	—
Voltage indication in combination with HR interface	■	—
Voltage indication in combination with post insulator	■	—
Direct connection from HR interface to directional fault indicator	—	—
Direct connection from post insulator to directional fault indicator	—	■
Capacitive interface integrated in switchgear	■	■
High-precision voltage measurement	—	—
Installation on T connector set	—	—
Installation on A cone	—	—
Connection to Wega possible	—	—
Voltage calibration necessary	■	■

Capacitive voltage coupling

for Wega series in air-insulated switchgears



C1A2-24	Cable length [m]	Rated voltage [kV]	Order no. set
For installation on cable terminations ¹⁾			
Driescher:	LDTM-12/24		V38-9100-061-001 (without Wega)
Driescher:	TSL-20		
Driescher:	TSL-G20		
Calor Emag:	C2-20	4,5	V38-9100-061-002 (Set incl. Wega 1)
Calor Emag:	C3-10/20	12, 24	
F&G:	Concordia-Sprecher 12		
F&G:	EA20		V38-9100-061-003 (Set incl. Wega 2)
Leukhardt	10 kV		

1) Further types of switchgear on request.
Wega series as well as set of connection cables see page 88



C11x	Voltage [kV]	Order no.
C111-12	max. 12	3 x 48-0101-002
C112-24	max. 24	3 x 48-0101-003
C113-36	max. 36	3 x 48-0101-004

Wega 1 V for capacitive support C11x (see page 86)



Equipment set	Order no.
1 integrated voltage detecting system	
Wega 1 V	51-1900-108
3 Coaxial cable	
3.000 mm	49-6003-201
5.000 mm	49-6003-213
6.000 mm	49-6003-210
7.500 mm	49-6003-215
10.000 mm	49-6003-212
1 Earth connection cable	49-0511-016

Further cable lengths on request.

Measuring cable sets between capacitive support C11x and Sigma D, Sigma D+, Sigma D++, ComPass B 2.0, ComPass BS 2.0



Capacitive support	Nominal voltage	Input Indicator	Cable length	Order no.
C111-12 (PSA 10)	10 kV	AMP	8.000 mm	49-0509-245
C112-24 (PSA 20)	20 kV	AMP	4.000 mm	49-0509-246

Further capacitive values and cable lengths on request.

Measuring cable sets between capacitive support C11x and ComPass B



Capacitive support	Nominal voltage	Input Indicator	Cable length	Order no.
C111-12 (PSA 10)	10 kV	4-pole series plug	2.000 mm	49-0509-061
C112-24 (PSA 20)	20 kV	4-pole series plug	2.000 mm	49-0509-062

Further capacitive values and cable lengths on request.

Resistive voltage sensors for high-precision voltage measurements

for ComPass B 2.0 series

with shielded 2 pole cable with connector, connecting terminal resistor and termination resistor

For gas-insulated switchgears



RDP2.1-24	Cable length [m]	Voltage [kV]	Order no. set
For T connector set ¹⁾			
Suitable for MS connectors			
Nkt cables:	CB-12, CC-12, CB-24, CC-24		
Raychem:	RSTI-58xx, RSTI-CC-58xx		
Nexans:	430TB, 430PB, K430TB, K430PB	3,70	12, 24
Südkabel:	SET12, SET24, SEHDT 13.1, SEHDT23.1, SAT12, SAT24, SEHDK23.1, MUT23, MUT23.1, AD23.1SP		38-9100-131
Cellpack:	CTS 630A, CTSK630A		



RDP1-24	Cable length [m]	Voltage [kV]	Order no. set
For T connector set ¹⁾			
Nexans:	(K)400TB		
Cellpack:	CTS-S	3,70	12, 24
Südkabel:	SEHDT 13, SEHDT 23		38-9100-013



RDP2-24	Cable length [m]	Voltage [kV]	Order no. set
For T connector set ¹⁾			
NKT:	CB-24, CC-24		
Raychem:	RSTI-58xx, RSTI-CC-58xx	3,70	12, 24



RDP3-24	Cable length [m]	Voltage [kV]	Order no. set
For T connector set ¹⁾			
Nexans:	(K)430TB-630A, (K)300 PB-630A		
Südkabel:	SET24, SEHDT23.1, SAT24, SEHDK23.1, SAK24, MUT23, MUT23.1, AD23.1SP	3,70	12, 24



RDP4-24	Cable length [m]	Voltage [kV]	Order no. set
For T connector set ¹⁾			
Cellpack:	CTS630A, CTKS630A	3,70	12, 24



RDP5-24	Cable length [m]	Voltage [kV]	Order no. set
For T connector set ¹⁾			
Nexans:	(K)480TB-630A, (K)800PB-630A, (K)484TB-630A, (K)804PB-630A, (K)489TB-630A, (K)809PB-630A, 800SA	3,70	12, 24

¹⁾ Further connector sets on request.

Voltage sensors



RDG3-24	Cable length [m]	Voltage [kV]	Order no. set
Sensors with adapters for A cones	6,00	12, 24	38-9100-026



RDP1-36	Cable length [m]	Voltage [kV]	Order no. set
For T-connector ¹⁾ Nexans Südkabel M400TB, SEHDT 33	6	36	3x 38-9100-122



RDP2-36	Cable length [m]	Voltage [kV]	Order no. set
For T-connector ¹⁾ NKT cables CB36-630, CC36-630 TE/ Raychem RSTI x95x, RSTI-CC x95 TE/ Raychem RSTI 68xx, RSTI-CC 68xx	6	36	3x 38-9100-127



RDP3-36	Cable length [m]	Voltage [kV]	Order no. set
For T-connector ¹⁾ Südkabel SET36, SDEHDK36 SEHDK36 MUT33	6	36	3x 38-9100-127



RDP5-36	Cable length [m]	Voltage [kV]	Order no. set
For T-connector ¹⁾ Nexans M480TB, M800PB M484TB, M804PB M484TB, M809PB 800SA	6	36	3x 38-9100-122



Connection cable	Cable length ¹⁾ [m]	Order no.
For the provision of voltage information from ComPass B / BS 2.0 to ComPass B / BS 2.0	1,00	49-0509-311

¹⁾ Further cable lengths on request.

For air-insulated switchgears



RDM3-24	Cable length [m]	Voltage [kV]	Order no. set
For different switchgear manufacturers	6,00	12, 24	38-9100-050

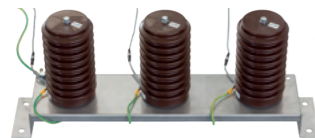

RDM3-24	Cable length [m]	Voltage [kV]	Order no. set
For different switchgear manufacturers, with retaining plate for installation on cable brackets	6,00	12, 24	38-9100-051

For short-circuit and earth fault indicators and integrated voltage detecting systems

WALL-MOUNTED HOUSING

for the installation of short-circuit and earth fault indicators as well as integrated voltage detecting systems outside the switchgear



Product information
W x H x D 125 x 75 x 125 mm
Order no. 49-9001-001 bottom cable entry 49-9001-002 rear cable entry



Product information
W x H x D 125 x 175 x 125
Order no. 49-9001-017 incl. earthing bar



Product information
W x H x D 125 x 75 x 75 mm
Order no. 49-9001-006



Product information
W x H x D 290 x 74 x 200 mm
Order no. V49-9001-007-001 incl. earthing bar

EXTERNAL SIGNAL LAMP

for installation outside the switchgear



ESL2-B, 3 LEDs, red	Order no.
5 m connection cable, with battery, for permanent contact	49-0813-102
10 m connection cable, with battery, for permanent contact	49-0813-103
15 m connection cable, with battery, for permanent contact	49-0813-104



ESL2.1-B, 3 LEDs, bicolour red/green	Order no.
5 m connection cable, with battery, for permanent contact	49-0816-102
10 m connection cable, with battery, for permanent contact	49-0816-103
15 m connection cable, with battery, for permanent contact	49-0816-104



ESL 1 LED, bicolour red/green	Order no.
2 m connection cable, with battery, without fibre optic cable	49-0704-001

Technical data	
Display	3 ultra-bright LEDs, colour red or red/green, 5 mm lens diameter
Flashing frequency	30 flashes per minute, On-time > 30 ms
Internal device supply	Integrated Lithium battery, expected life > 20 years, Potential free contact; Min. flashing time: 1,200 h
Protection class, DIN EN 61140	SELV, protection class III
Degree of protection DIN EN 60529	IP 65
Impact resistance EN 62262	IK06
Housing material	Polycarbonate, UV and weather resistant
Dimensions	83 x 81 x 51 mm (H x W x D)
Available cable lengths	5 m, 10 m, 15 m, other lengths on request
Mounting material	The fixing material is included in the delivery. Cylinder head screw M5x45 DIN84, steel, washer, nut M5, stainless A2 (slotted) Optional: Cross screw 5x60 mm, drive: PH2 with 8 mm dowel (can be ordered with separate part number)

Installation system

for Sigma D series and ComPass series



	Order no.
Tablet for parameter setting during installation or monitoring, incl. cover, pencil, power supply and USB cable	49-6022-010

Temperature sensor PT100 (2-conductor)



	Order no.
Temperature range	-50 °C to +180 °C
Dimension	6 x 50 mm
Cable length	10 m (silicone, 2 ferrules)
Protection degree	IP65

Fibre optic cables



	Order no.
Fibre optic cables 3 m (Standard length for Single-phase current sensors)	49-0602-009
Fibre optic cables 4 m (Standard length for summation current transformer)	49-0602-001
Fibre optic cables 1,8 m (Standard length for external signal lamp)	49-6007-206

Accessories for Opto series



	Order no.
Cutting tool for fibre optic cables	49-0109-003



	Order no.
Transformer with cable for top-hat rail mounting (115 V – 230 V AC / 24 V – 48 V AC)	49-0921-002



	Order no.
Optical testing unit to excite the indicator for connection to the fibre optic cable plug	49-0109-002

Accessories Plug-in housing



	Order no.
Disassembly clip	49-9090-029



	Order no.
Spring clip suitable for front plate thickness 2 mm (standard)	49-9090-018
Spring clip suitable for front plate thickness 3 mm	49-9090-019
Spring clip suitable for front plate thickness 4 mm (Eaton standard)	49-9090-028

Applications

Load flow monitoring in the low-voltage grid using an Interface box



PRODUCT FEATURES

The Interface box can be used to adapt voltages from different voltage levels to the Wega input of short-circuit indicators.

- ▶ 3x 100V or 3x 110V: Secondary voltage signal from medium-voltage transformer
- ▶ 400/230V: Direct connection in the low voltage

The voltage signals from the interface box can be provided to the following devices:

- ▶ ComPass B 2.0

Depending on the device functions, only measured values corresponding to the device accuracies and transmission functions can be further processed:

- ▶ High-precision current and voltage measurements with 1% using ComPass B series devices
- ▶ Highly accurate voltage measurements with 1% using ComPass B 2.0 device
- ▶ Current measurement range up to 1,250 A possible

YOUR ADVANTAGES

- ▶ A system also for low voltage with 400/230V
- ▶ A system for special applications in medium voltage with 100 V / $\sqrt{3}$
- ▶ Measured value availability in the control room and on site
- ▶ Remote transmission options via RS485/Modbus
- ▶ Provision of measured values: V, I, f, T, S, P, Q, E in medium and low voltage
- ▶ Switching function of 2 switching elements
- ▶ Short-circuit and earth fault direction detection in the medium voltage
- ▶ The device functions can be found on the corresponding device pages

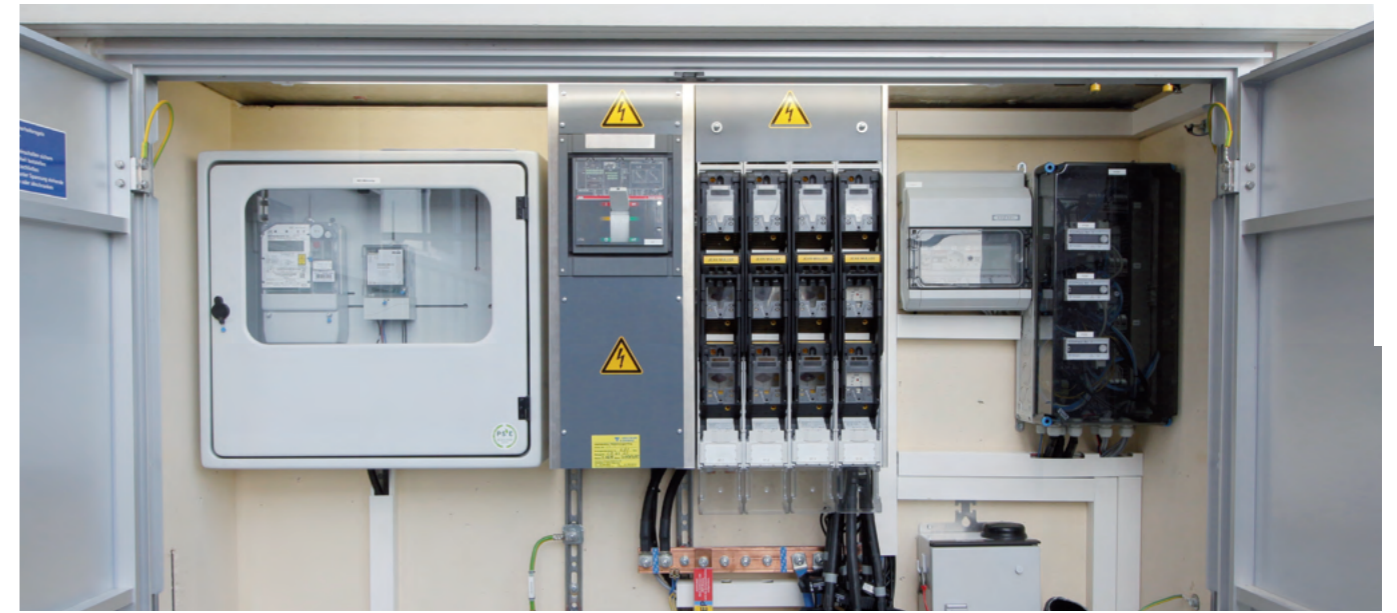

Equipment set	Page	Order no.	Accessories	Page
Interface box		49-6021-001	Installation system	59
ComPass B		38-4102-001	Connection to remote monitoring	71
3 Single-phase current sensors	50		External signal lamp	58
1 Voltage signal	54		Temperature sensor PT100	59
			Wall-mounted housing	58
			Disassembly clip	59
			Spring clip	59

Trip Flag

Trip indicator relay for trip display



Trip Flag

PRODUCT FEATURES

- ▶ Suitable for connection to CT powered protection relays in medium voltage switchgears
 - ▶ 2 drop indicators (black/red)
 - ▶ OC relay trip: Overcurrent relay trip
- ▶ ETFS trip: External trip forced switch
- ▶ Controllable via electrical impulse output
- ▶ 2 changeover contacts per relay, self-holding
- ▶ Test / reset function for indicator and relay contacts via rotary knob

The Trip Flag is a drop indicator relay for two independent indications. It is suitable for the trip display of CT powered protection devices with electrical impulse output.

In addition to the display, output relays are activated. Each output has 2 changeover contacts. The output contacts and the display are latching and are reset manually via a rotary knob.

The Trip Flag is suitable for protection devices from Woodward (WIC1, WIB1, WIP1).

For devices of other manufacturers the electrical impulse of the outputs of the protection relays needs to be 24 V DC and $E \geq 0.01 \text{ Ws}$.

Technical data	
Indication	2 trip displays (black / red)
Remote signal	2 changeover contacts per trip display
Remote contact	Potential-free contacts, bistable Contact capacity: 230 V AC / 1 A / 62.5 VA max.; 220 V DC / 1 A / 60 W max.
Input signal	Electrical impulse, 24 V DC $\geq 0.01 \text{ Ws}$
Test / Reset	Manually via rotary knob
Housing	Polycarbonate, IP40 front panel, IP20 terminals
Temperature range	-30 °C to +70 °C

Equipment set	Order no.	Accessories	Page
1 Display unit Trip Flag	49-9010-001	Wall-mounted housing	58
		Disassembly clip	59
		Spring clip	59

Dimension drawing see on page 132 ff | M5

Product matrix

Overhead faulted circuit indicators



Function	Navigator LM	Navigator LM HV	Navigator LED + Flag	Smart Navigator 2.0	Smart Navigator 2.0 HV	Smart Navigator 2.0 LC + Pole Master
Short-circuit indication	■	■	■	■	■	■
Directional indication	—	—	—	■ (red/green)	■ (red/green)	■ (red/green)
Self-adjustment/ fixed settings	■/■*	■/■*	■/■*	■/■*	■/■*	■/■*
Monitoring	—	—	—	■	■	■
Recloser mode	■	■	■	■	■	■
Rated voltage	≤46 kV	≤161 kV	≤46 kV	≤69 kV	≤161 kV	≤69 kV
Withstand current	25 kA / 3 s	40 kA / 1 s	31,5 kA / 3 s	40 kA / 1 s	40 kA / 1 s	40 kA / 1 s
Trip settings						
I>> short-circuit trip current	200–1.000 A	200–1.000 A	50–1.000 A	20–1.200 A	20–1.200 A	7–1.200 A
tI>> response delay	100 ms	100 ms	100 ms	100 ms	100 ms	100 ms
Reset						
Manual	■	■	■	■	■	■
Remote	—	—	—	■	■	■
Automatic time reset	■	■	■	■	■	■
Current restoration	■	■	■	■	■	■
Voltage restoration	■	■	■	■	■	■
Test						
Via magnet	■	■	■	■	■	■
Remote	—	—	—	■	■	■
Communication						
LTE CAT-M1, 4G, 450 MHz	—	—	—	■	■	■
Parameter setting						
Local	—	—	—	■	■	■
Remote	—	—	—	■	■	■
Monitoring						
Conductor temperature	—	—	—	■	■	■
Conductor						
Diameter	8–29 mm	13–36 mm	8–29 mm	≤33 mm	≤33 mm	≤33 mm
Power supply						
Long-life lithium cell, shelf life	≥20 years	≥20 years	≥20 years	≥10 years	≥10 years	≥10 years
Battery status indication	■	■	■	■	■	■
Mechanic						
Weight	470 g	470 g	425 g	1 kg	1 kg	1,0 kg / 2,8 kg
Degree of protection IP65	—	—	—	—	—	■
Degree of protection IP68	■	■	■	■	■	—
Temperature range	-40 °C to +85 °C	-40 °C to +85 °C	-40 °C to +85 °C	-40 °C to +85 °C	-40 °C to +85 °C	-40 °C to +85 °C

* Fixed trip current values only with Navigator PM

Navigator LM | Navigator LM HV

Overhead faulted circuit indicator



Navigator LM



Navigator LM HV

PRODUCT FEATURES

- ▶ LED indication with 360 degrees of visibility
- ▶ Double-flashing mode upon detection of a second fault
- ▶ Battery status indication
- ▶ Reset depending on type: manual, current restoration, voltage restoration
- ▶ Mounting on live overhead lines possible
- ▶ Navigator LM HV: permissible voltage ≤ 161 kV

The Navigator fault passage indicator is an electronic device which is designed for medium voltage utility overhead lines.

The indicator is provided with a self-adjusting load-dependent control of the trip current level. This function allows the indicator to continuously sample the load current on overhead lines and automatically set a corresponding trip value for fault detection as a function of the load current. The maximum load current sampled by the indicator, is kept in a memory for a period of at least 72 hours. Thus, the indicator is most favourably adapted to the network to be monitored, even if low load is currently present.

The indicator is provided with a built-in battery control. When the battery capacity decreases from a total indicating time of 500 hours to a residual time of 50 hours, the yellow LED of the display starts flashing for a period of 6 months.

The Navigator LM differentiates between two subsequent short-circuit detections. Upon the detection of a first short-circuit, the LED indicator light starts flashing at equal rates. The detection of a second short-circuit (e. g. after ARC) switches the LED to double flashing mode.

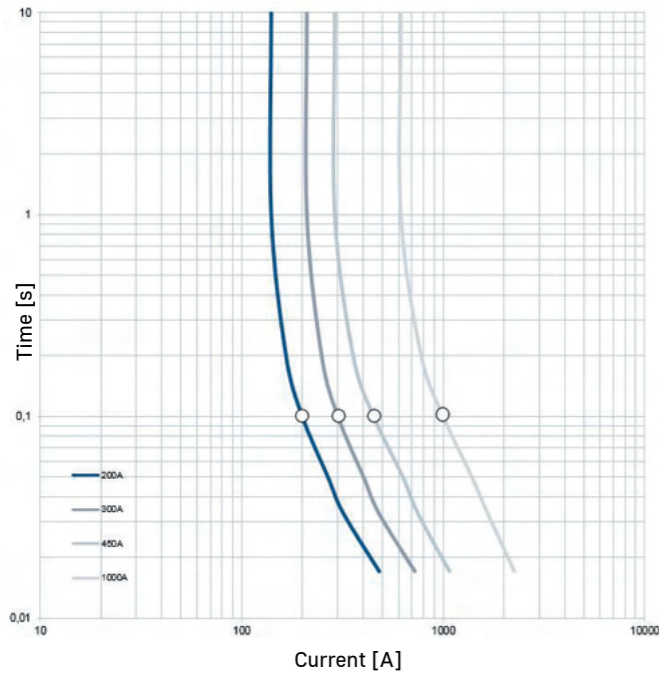

Current / time characteristic

Load current [A]	0-50	78	100	170
Response value [A]/100 ms	200	300	450	1,000

Technical data	Navigator LM Navigator LM HV			
	Version A	Version B	Version C	Version E
I>> Short-circuit trip current	≥ 200 A / ≥ 100 ms, load-dependent self-adjustment (see current/time characteristic curve)			
Accuracy	± 10 % at 20 °C			
Self-adjustment	≥ 30 A load current			
Trip factor	4–6 x load current (see current/time characteristic curve)			
Adjustment delay	60 s Load current flow duration			
Peak load memory	72 h			
Indicators (short circuit / earth fault)	<ul style="list-style-type: none"> ▶ 4 red LEDs (>5,000 mcd or 7,000 mLm per LED) ▶ 2 yellow LEDs (>5,000 mcd or 7,000 mLm per LED) 			
Visibility	>50 m / day, >150 m / night, 360 degrees of visibility			
Flash rate	30 flashes per minute, total indication time >500 h			
Reset	Version A	Version B	Version C	Version E
Manual	Via magnet	Via magnet	Via magnet	Via magnet
Automatic time reset	4 h ± 10 % (2 or 8 h)	4 h ± 10 % (2 or 8 h)	4 h ± 10 % (2 or 8 h)	4 h ± 10 % (2 or 8 h)
Current restoration	load current >3 A	—	Red LEDs turn off, yellow LEDs turn off after manual or time reset	—
Voltage restoration	—	—	—	≥ 5 kV line voltage
Power supply	Replaceable lithium batteries, service life ≥ 20 years			
Battery check	1 yellow LED, flash rate: 6 per minute, 0,5 years			
Max. permissible voltage	Navigator LM: ≤ 46 kV / 50 Hz or 60 Hz Navigator LM HV: ≤ 161 kV / 50 Hz or 60 Hz			
Withstand current	Navigator LM: 25 kA / 3 s Navigator LM HV: 40 kA / 1 s			
Cable diameter range	Navigator LM: 8–29 mm Navigator LM HV: 13–36 mm			
Housing	UV resistant glass-fibre reinforced plastic, IP68 Clamping yoke: stainless steel			
Temperature range	-40 °C to +85 °C (IEEE 495: -40 °C to +85 °C)			

Order no.						
41	—	2	1	01	—	1 1 1
Navigator series	Navigator LM	Flashing frequency	Line diameter	Reset	Response value	Automatic time reset
41	2	0 = Single flashing 1 = Single and double flashing	01 = 8–29 mm (LM-Version) 08 = 13–36 mm (HV-Version)	1 = Version A 2 = Version B 3 = Version C 5 = Version E	1 = 200 A / 100 ms (50 / 60 Hz)	0 = 2 h 1 = 4 h (Standard) 2 = 8 h

Navigator PM (without self-adjustment with fixed response values) and other special types on request

Product matrix see on Page 63

Dimension drawing see on page 132 ff | M8

Accessories	Page
Hot stick with hook	70
Installations tool	70
Magnet (Test/Reset)	70

Navigator LED + Flag

Overhead faulted circuit indicator



Navigator LED + Flag

PRODUCT FEATURES

- ▶ 72 hour peak load memory
- ▶ 4 hours LED automatic reset
- ▶ 1, 2 or 7 days flag automatic reset
- ▶ Self diagnostic battery circuit
- ▶ Replaceable lithium cells
- ▶ 360 degrees visibility
- ▶ Manual test and reset
- ▶ Automatic inrush restraint
- ▶ Microprocessor controlled

The Navigator LED + Flag is a faulted circuit indicator for power distribution overhead lines. The faulted circuit indication is visualised by a large red flag in combination with LEDs.

The Navigator LED + Flag has a load tracking characteristic. This means it constantly monitors the load current magnitude on the line and automatically adjusts its trip current level for a fault. The highest current sensed for at least 60 seconds will establish a trip point (~4 times load) in memory and holds this value for 72 hours. If the load current reaches or exceeds the stored load current level at any time, a new trip point is registered and the memory time of 72 hours starts again. If load current does not meet or exceed the established level for 72 hours, the Navigator LED + Flag will sense and re-establish a new lower trip point. When a fault current exceeds the trip point, the indicator activates the red flag and high intensity red LEDs will also flash. The LEDs are reset by current, time or manually whichever comes first. The red flag is reset by either time or manually, giving both an indication on permanent as well as on momentary faults. The reset times for the LED and Flag can be selected independently to combine the advantages of a blinking indicator (better visibility) at night and a mechanical flag for difficult to reach rural applications.

Technical data	Navigator LED + Flag		
	Version A	Version B	Version E
Trip current	≥50 A / ≥100 ms		
Accuracy	±10 % at 20 °C ±20 % at -30 to +70 °C		
Self-adjustment	≥20 A load current		
Trip factor	4 x load current		
Adjustment delay	60 s		
Peak load memory	72 h		
Indication (short-circuit / earth fault)	<ul style="list-style-type: none"> ▶ Mechanical flag ▶ 3 red LEDs for fault indication ▶ 1 yellow LED for low-battery indication 		
Visibility	>50 m / day, >150 m / night, 360 degrees of visibility		
Flash rate	30 flashes per minute, total indication time >1,500 h		
Reset	Version A	Version B	Version E
Manual	■	■	■
Automatic time reset	<ul style="list-style-type: none"> ▶ LED: 4 h ▶ Flag: 4 h, 1, 2, 3 or 7 days 	<ul style="list-style-type: none"> ▶ LED: 4 h ▶ Flag: 4 h, 1, 2, 3 or 7 days 	<ul style="list-style-type: none"> ▶ LED: 4 h ▶ Flag: 4 h, 1, 2, 3 or 7 days
Current restoration load current >3 A	■	-	-
Voltage restoration line voltage ≥5 kV	-	-	■
Power supply	Lithium battery, replaceable, shelf life ≥20 years		
Battery check	1 yellow LED, flash rate: 6 per minute (only while flag is reset)		
Max. permissible voltage	≤46 kV / 50 Hz or 60 Hz		
Withstand current	25 kA / 1 s		
Cable diameter range	4-29 mm 8-29 mm		
EMC	IEC 61000-4-2 (ESD), IEC 61000-4-3 (HF)		
Housing	UV resistant glass-fibre reinforced plastic, IP68 Clamping yoke: stainless steel		
Temperature range	-30 to +70 °C (IEEE 495: -40 to +85 °C)		

Product matrix see on Page 63

Dimension drawing see on page 27ff | M8

Order no.						
41	—	3	2	01	—	1 2 1
Navigator series	Navigator LED+Flag	Flashing frequency	Line diameter	Reset	Trip current	Automatic time reset
41	3	1 = 60 Hz 2 = 50 Hz	01 = 8-29 mm (LM-Version) 04 = 4-29 mm (HV-Version)	1 = Version A 2 = Version B 5 = Version E	0 = 100 A / 200 ms 1 = 100 A / 100 ms 2 = 200 A / 200 ms (60 Hz) 2 = 200 A / 100 ms (50 Hz) 6 = 50 A / 200 ms (60 Hz) 6 = 50 A / 100 ms (50 Hz)	1 = 4 h 5 = 3 days 6 = 1 day 7 = 7 days 8 = 2 days

Accessories	Page
Hot stick with hook	74
Hot stick for installation tool	74
Installations tool	74
Magnet (Test/Reset)	74

Smart Navigator 2.0

Self-powered overhead line sensor | smart faulted circuit indicator



PRODUCT FEATURES

- ▶ Quick fault detection – locally and in the control room at the same time
- ▶ Remote monitoring of measured values – high-precision current measurements, load flow direction and conductor temperature
- ▶ Embedded WAN communication – no box on the pole required – quick and easy installation saves costs
- ▶ Remote configuration and updates via iHost or locally via USB transmitter
- ▶ High availability of the medium voltage overhead lines – reduces outage times

The Smart Navigator 2.0 is the ideal solution for monitoring overhead line networks. It recognises and reports faults, voltage drops, overloads and other faults in the grid and reports them remotely without delay. It enables faster fault localisation, optimum utilisation of grid capacity and therefore improved supply quality.

The Smart Navigator 2.0 is easy to install, configure and maintain. The indicator is a self-powered sensor, which harvests its power supply from the overhead line. Power is stored in a rechargeable lithium cell for periods with low or no load current. It is compatible with various communication technologies and can be maintained remotely via a web or mobile application.

One set is required for each overhead line section to be monitored. The set consists of a master and two satellites. The satellites report all measured values and fault information to the master, which communicates with the control room via iHost.

Accessories	Page
Connection to iHost	72
Hot stick with hook	70
USB transmitter	70
Magnet (Test / Reset)	70

Technical data	Smart Navigator 2.0	Smart Navigator 2.0 HV
I>> Short-circuit trip current	7 – 1,200 A (Self-adjustment) or fixed trip up to 2,000 A	
Self-adjustment	≥2 A Load current	
Trip factor	4 x Load current	
Peak load memory	72 h	
Current measurement accuracy	±2 A (0–10 A) 3 % (10–600 A) 10 % (600–10,000 A)	
Indicators (short circuit / earth fault)	Ultra-bright high power LEDs	
Visibility	>50 m / day, >150 m / night, 360 degrees of visibility	
Flash rate	30 flashes per minute	
Reset		
Manual	Local by magnet or via USB transmitter, Remote optional	
Remote reset	Via iHost	
Automatic time reset	Can be parameterised	
Current restoration	>3 A Load current	
Voltage restoration	>5 kV line voltage	
Power supply	▶ Power inductively from line current (>5 A) ▶ Internal rechargeable back-up-battery	
Power distribution line voltage	≤69 kV (L–L)	≤161 kV (L–L)
Withstand current	600 A continuous, 40 kA / 1 s	
Event reporting	▶ Fault detection ▶ Loss of current or voltage ▶ Fault current magnitude and duration	
Remote monitoring	Load current monitoring (max / min / average) Voltage presence or absence (E-field based detection)	
Communication	WAN: 2G/4G, 4G LTE CAT-M1, 450 MHz LTE 1 SIM card format 2ff TLS encryption Local: 868 MHz short-range radio	
SCADA	▶ DNP3 from Master to iHost ▶ iHost supports DNP3, 104, 101 and other protocols ▶ iHost acts as data concentrator, fleet and connection manager	
Configuration and firmware	▶ Remotely (re)configurable settings over the air ▶ Supports firmware updates over the air ▶ Remote interface from SCADA / iHost or with USB transmitter on site	
Cable diameter range	Up to 33 mm	
Housing	UV resistant polycarbonate, IP68	
Temperature range	–40 °C to +85 °C	

Variants with extended operating ranges and functions are available on request.

Dimension drawing see on page 132 ff | M9

Order no.				
44 –	10	1	0 –	1 00
Navigator 2.0 44	Hardware 10 = 2,4–69 kV –20 °C–+60 °C Rechargeable battery 11 = 2,4–69 kV –40 °C–+85 °C Rechargeable battery 12 = 2,4–69 kV –40 °C–+85 °C Non-rechargeable battery 20 = 69–161 kV –20 °C–+60 °C Rechargeable battery 21 = 69–161 kV –40 °C–+85 °C Rechargeable battery 41 = 9–161 kV 1200A max –40 °C–+85 °C Rechargeable battery	Function 1 = Without fault direction detection 3 = With fault direction detection	0	Cellular 0 = without modem (satellite) 1 = 4G Cat-1 (EU), 2G 3 = 4G Cat-M1 450MHz 5 = 4G Cat-M1 (WW), 2G
				Variants 00 = Standard settings

Accessories

For overhead line faulted circuit indicators



Commissioning and testing	Order no.
Magnet (Test/Reset)	49-6001-002



Installations tools	Order no.
To install and remove the Navigator series	49-6006-004
To install and remove Smart Navigator 2.0 & LC	49-6006-005
To install and remove Smart Navigator 2.0 HV	49-6006-006



	Order no.
Telescopic stick with universal gear coupling (length extended: 6.43 m, length retracted: 1.63 m) Rated voltage: 123 kV (only when fully extended)	65-0305-001

Telescopic stick with universal gear coupling (length extended approx. 12m, length retracted approx. 1.8m) Rated voltage: 132 kV (only when fully extended)	65-0305-004
---	-------------



	Order no.
USB transmitter for Smart Navigator 2.0	28-5000-001
USB transmitter for Smart Navigator 2.0 (915 MHz)	28-5000-002
USB transmitter for Smart Navigator 2.0 (923 MHz)	28-5000-006

Hot stick with hook

for overhead faulted circuit indicator installations and removals

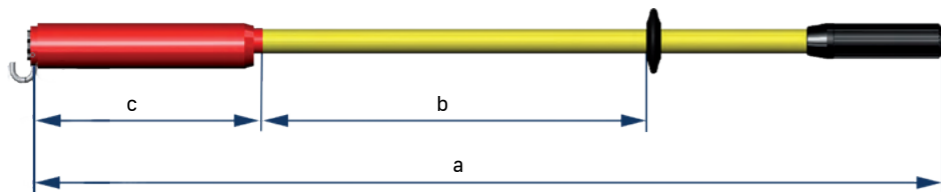

Hot stick with hook

Nominal voltage range [kV]	Dimensions [mm]			Order no.
	a	b	c	
1–24	1,200	500	310	65-0301-001
1–36	2,000	900	310	65-0301-002
1–36	3,000	900	310	65-0301-003
1–52	2,000	900	310	65-0301-004

Remote monitoring

General information



Energy supply grids are becoming more and more complex. One major reason for this is the growing number of decentralised feeding lines originating from renewable energy sources. This trend is expected to continue, as evidenced by the discussions about intelligent substations and smart grids. Additional decentralised energy generation systems, such as fuel cells or battery stations, could be integrated into the grids in future.

Challenges faced by network operators:

- ▶ Increasing network complexity
- ▶ Ensuring consistently high availability of energy supply
- ▶ Increasing competitive pressure

In addition, the bonus / penalty regulations arising from SAIDI metrics create a high incentive for the reduction of power outage durations.

Horstmann solution

Remote monitoring solutions with direct reports of short-circuit and earth fault indicators installed in the network to a control room or directly to field service staff via their mobile devices.

- ▶ Specific coordination of service teams
- ▶ Minimisation of power outage periods
- ▶ Continuous overview of the most important network parameters

Horstmann's product range includes different remote monitoring solutions (radio-based) for underground cable and overhead lines in a medium voltage network. Leading this innovative approach is the iHost system (see page 82) which collects data from short-circuit and earth fault indicators in the field, evaluates it and provides utilities with information about network performance and irregularities.



OUR PRODUCT AT THE CUTTING EDGE

As grids become increasingly complex and heterogeneous, greater demands are placed on the availability of electricity networks. The increasing use of renewable energy sources and the desire for decentralisation play important roles in this development.

Horstmann solution

Information based network monitoring – the iHost system reduces power outage times thanks to quicker availability of information.

The iHost system collects data from devices such as from the short-circuit and earth fault indicators in the field (e.g. of the Compass series), evaluates the data in a data concentrator and shares it with the control room systems and / or mobile terminals. Fault information and exceeded limits can also be send by e-mail and SMS.

YOUR ADVANTAGES

- ▶ Short-circuit alarms directly in the control room
- ▶ Transparency on the web through evaluation of archived monitoring data
- ▶ Remote management and maintenance of field devices

iHost Cloud

For smaller scale projects or pilot schemes iHost Cloud is the best choice. Quick and easy implementation works without software installation. Handling is very user-friendly – all you need is a web-enabled device, your user name and password. Customised notifications in case of a fault or alarms are possible via SMS and e-mail.



iHost

Data concentrator for short-circuit and earth fault indicators

- ▶ Bundles and processes all data received from remote field devices
- ▶ Provides data access at any time in various ways and devices

Central management of all field devices

- ▶ Grid monitoring: system overview, data analysis, function check
- ▶ Configuration and firmware updates

Data on demand

- ▶ Customised visualisation of data and alarms
- ▶ Individual notifications, generated automatically

Embedded database

- ▶ Grid data available from day one of installation
- ▶ Flexible data provision for asset management, planning, engineers and further user

Full control over your own data with on-premise installation

- ▶ Data to be stored in Horstmann cloud
- ▶ On premise installation with SCADA connection over IEC 60870-5-101 / -104 or DNP3 serial / IP
- ▶ The same user interface in all variants simplifies the transition and reduces the familiarisation period

Features	iHost Cloud
Hardware / Server arrangement	High availability cluster Software as a service
Operating system (OS)	Cloud service / data centre
Visualisation	Web browser
Suitable Horstmann RTUs	Smart Navigator 2.0 Reporter 3.0 Reporter 4.0
Communication	SIM card with public APN. Available on request or use your own.
iHost licence type	Annually per RTU
RTU count	1 – 1,000
Limits of users / user roles	50 / 3
Maps	Yes
Notifications	Yes (e-mail / SMS)
Historian	Yes
Data access API	Yes
SCADA protocols	n/a
Simultaneous SCADA channels	n/a

iHost Cloud	Order no.	Accessories	Page
1 Licence		Smart Navigator 2.0	68
Cloud per RTU / year	79-1010-000	Reporter 3.0	76
1 SIM card		Reporter 4.0	78
Cloud SIM-M*	79-1041-000		
Cloud SIM-L**	79-1042-000		

* SIM-M: 2G, 3G, 4G, 20 MB Data volume / month / SIM card.

** SIM-L: 2G, 3G, 4G, 4G LTE-M, 5G 50 MB Data volume / month / SIM card..

iHost Solo | Pro

Remote monitoring software for SCADA

With iHost Solo and iHost Pro all measured values as well as fault information are transferred directly to your SCADA. All data is stored in iHost. Installed in your premises these solutions provide you multiple options regarding the use, analysis and visualisation of data.

iHOST SOLO

iHost Solo is designed for medium-sized distribution networks. All data is stored exclusively on the customer's server and backed up.



iHost Solo

iHOST PRO

iHost Pro is the ideal solution for high system availability requirements. Two servers ensure this through parallel and synchronised operation.

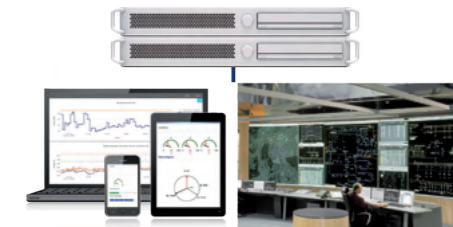

iHost Pro

Features	iHost Solo			iHost Pro
	Software	Software/Hardware	Software/Hardware/101	
Hardware / Server arrangement	Single installation of the iHost software on a customer supplied, pre-installed and virtual server	Single server, Horstmann supplied	Single server, Horstmann supplied with serial interface	Single installation of the iHost software on a customer supplied, pre-installed and virtual server
Operating system (OS)	Microsoft Windows Server BS			
Visualisation	Web browser and SCADA			
Suitable Horstmann RTUs	Smart Navigator 2.0 Reporter 3.0 Reporter 4.0			
Communication	Customer supplied SIM with private APN			
iHost licence type	One-time licence fees			Annual licence fees
RTU count	100 / 500 / 1,000			2,000 / 3,500 / 5,000
Limits of users / user roles	50 / 10			Unlimited / 50
Maps	Yes (option)			
Notifications	Yes (e-mail / SMS)			
Historian	Yes			
Data access API	Yes			
SCADA protocols	IEC60870-5-101 ¹⁾ IEC60870-5-104 DNP3 (serial) ¹⁾ DNP3 (IP)	IEC60870-5-104 DNP3 (IP)	IEC60870-5-101 IEC60870-5-104 DNP3 (serial) DNP3 (IP)	IEC60870-5-101 ¹⁾ IEC60870-5-104 DNP3 (serial) ¹⁾ DNP3 (IP)
Simultaneous SCADA channels	2			10

¹⁾ Customers server hardware must contain serial interface.

iHost Solo Software	Accessories	Page
1 licence	Smart Navigator 2.0	68
Solo 100 (SW)	Reporter 3.0	76
Solo 500 (SW)	Reporter 4.0	78
Solo 1000 (SW)		
1 software installation package (remote VPN access)		
1 technical support for 12 months		
iHost Solo Software / Hardware		
1 licence		
Solo 100 (SW/HW)		
Solo 500 (SW/HW)		
Solo 1000 (SW/HW)		
1 software installation package (remote VPN access)		
1 technical support for 12 months		
iHost Solo Software / Hardware / 101		
1 licence		
Solo 100 (SW/HW/101)		
Solo 500 (SW/HW/101)		
Solo 1000 (SW/HW/101)		
1 software installation package (remote VPN access)		
1 technical support for 12 months		
iHost Pro		
1 licence		
Pro 2000		
Pro 3500		
Pro 5000		
1 software installation package (remote VPN access)		
1 technical support for 12 months		



Detailed information you will receive from our sales staff or by e-mail via iHost@horstmannmbh.com

Reporter 3.0

Remote monitoring to iHost



Reporter 3.0

PRODUCT FEATURES

- ▶ Recording and forwarding of digital statuses, such as those generated by short-circuit or earth fault indicators, door contacts, etc.
- ▶ Transmission via bidirectional data connection to iHost
- ▶ Internal battery supply/ no auxiliary supply necessary

The Reporter 3.0 is used for the remote signalling of short-circuits, earth faults and additional status reports (door contact, temperature sensor etc.) from a medium-voltage network that are reported by short-circuit and earth fault indicators. The received reports are transferred to iHost through a bidirectional data connection. The Reporter 3.0 is housed in robust, weatherproof housing for wall mounting and can be configured using Windows-based PC software and iHost.

Reported short-circuits and earth faults are securely sent to SCADA via the iHost system and can be retrieved by any web-enabled device at any time. Notifications can also be received by e-mail and / or SMS.

- Fault indicator with relay contact
- Door contact
- Temperature sensor
- ...



Technical data	Reporter 3.0
Special features	<ul style="list-style-type: none"> ▶ Routine call ▶ Automatic date and time synchronisation ▶ Transmission of signal field strength ▶ Temperature sensor ▶ Fault and status notification via SMS and / or e-mail
Inputs	<ul style="list-style-type: none"> ▶ 16 digital inputs for potential-free relay contacts ▶ 2 analogue inputs (4–20 mA)
Communication	Bidirectional data connection to iHost
Indication (inside)	Control LEDs for data reception / connection
Power supply	Replaceable long-life lithium cell 7–10 years, min. 1,000 calls
Mobile network	4G / 2G
Housing	Glass fibre reinforced polycarbonate, IP66
Installation	Wall mounting
Temperature range	-30 °C to +70 °C

Equipment set	Order no.	Accessories	Page
1 Remote monitoring box Reporter 3.0	28-7330-022	Fault indicators with relay contacts	26-47
1 iHost solution			
iHost Cloud			
iHost Solo			
iHost Pro			

Product matrix on page 80

Dimension drawing see on page 132 ff | M10

Reporter 4.0

Remote monitoring to iHost



Reporter 4.0

PRODUCT FEATURES

- ▶ Detection and forwarding of digital states as generated e.g. by short-circuit or earth fault indicators, door contacts etc.
- ▶ Transfer via bidirectional data connection to iHost
- ▶ Auxiliary supply necessary

The Reporter 4.0 is used for the remote signalling of short-circuits, earth faults and additional status reports from a medium-voltage network. The information is transferred by ComPass B or ComPass B 2.0 in particular. Voltage, current, load flow direction, power factor, power, energy and frequency are also measured and monitored.

The received reports are transferred to iHost through a bidirectional data connection. The Reporter 4.0 is housed in robust, weatherproof housing for wall mounting and can be configured using Windows-based PC software and iHost.

Reported short-circuits and earth faults are securely sent to SCADA via the iHost system and can be retrieved by any web-enabled device at any time. Notifications can also be received by e-mail and / or SMS.

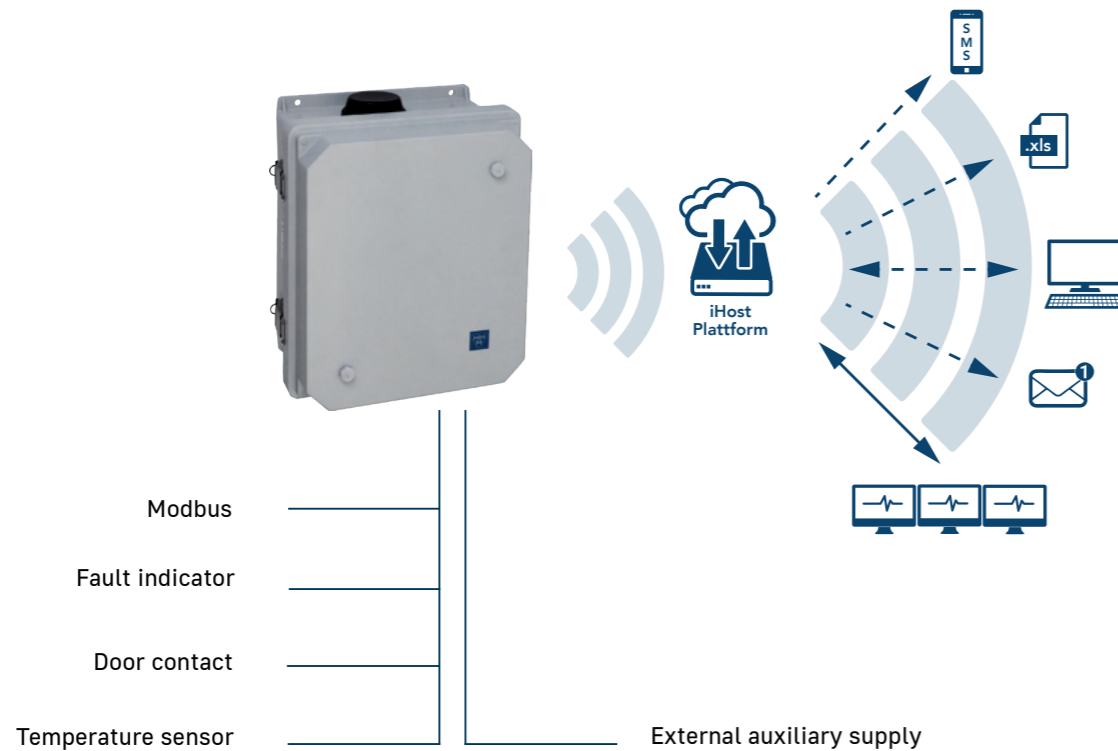

Technical data	Reporter 4.0
Special features	<ul style="list-style-type: none"> ▶ Routine call ▶ Automatic date and time synchronisation ▶ Transmission of signal field strength ▶ Temperature sensor ▶ Fault and status notification via SMS and / or e-mail
Inputs	<ul style="list-style-type: none"> ▶ 16 digital inputs (hardware) ▶ 8 analogue inputs (4–20 mA) (hardware) ▶ 63 Modbus (digital) – 47 if hardware inputs are used ▶ 68 Modbus (analogue) – 60 if hardware inputs are used
Interfaces	Modbus
Communication	<ul style="list-style-type: none"> ▶ Bidirectional data connection to iHost ▶ Detection and forwarding of analogue measurement values, such as voltage, current etc.
Indication	Control LEDs for data reception / connection / fault indicators
Power supply	
Internal Power supply	Back-up battery, max. 24 h
External auxiliary supply	100–240 V AC (50–60 Hz)
Mobile network	4G / 2G
Housing	Glass fibre reinforced polyester, IP66
Montage	Wall mounting
Temperature range	-20 °C to +65 °C

Equipment set	Order no.	Accessories	Page
1 Remote monitoring box Reporter 4.0		ComPass B	42
Reporter 4.0 for ComPass B	On request	ComPass B 2.0 series	44
Reporter 4.0 for ComPass B 2.0 and ComPass Bs 2.0	28-7503-002 ¹⁾		
1 iHost solution			
iHost Cloud			
iHost Solo			
iHost Pro			

¹⁾ Further variants on request.

Dimension drawing see on page 132 ff | M10

Product matrix

Remote monitoring



Function	Reporter 3.0	Reporter 4.0
SCADA		
iHost	■	■
Data source		
Short-circuit and earth fault indicator	■	■
Information		
Short-circuit and earth fault indication	■	■
Monitoring	—	■
Communication		
Inputs		
Analogue	2 (4–20 mA)	8 (4–20 mA)
Digital	16	16
Modbus	—	47 Modbus (digital) 60 Modbus (analogue)
Interfaces / Protocol	—	RS-485 / Modbus-RTU
Mobile network	4G / 2G	4G / 2G
Power supply		
External auxiliary supply	—	■ (100–240 V AC)
Back-up battery (rechargeable)	—	■
Long-life lithium cell	■	—
Housing		
Material	Glas fibre reinforced Polycarbonate	Glas fibre reinforced polyester
Degree of protection	IP66	IP66
Dimensions (W x H x D)	136 x 245 x 88 mm	291 x 362 x 186 mm
Cable ducts	3	4
Lock	Screws	Padlock
Mounting	Wall	Wall
Temperature range	-30 °C to +70 °C	-20 °C to +65 °C

Voltage detectors and voltage detecting systems

General information

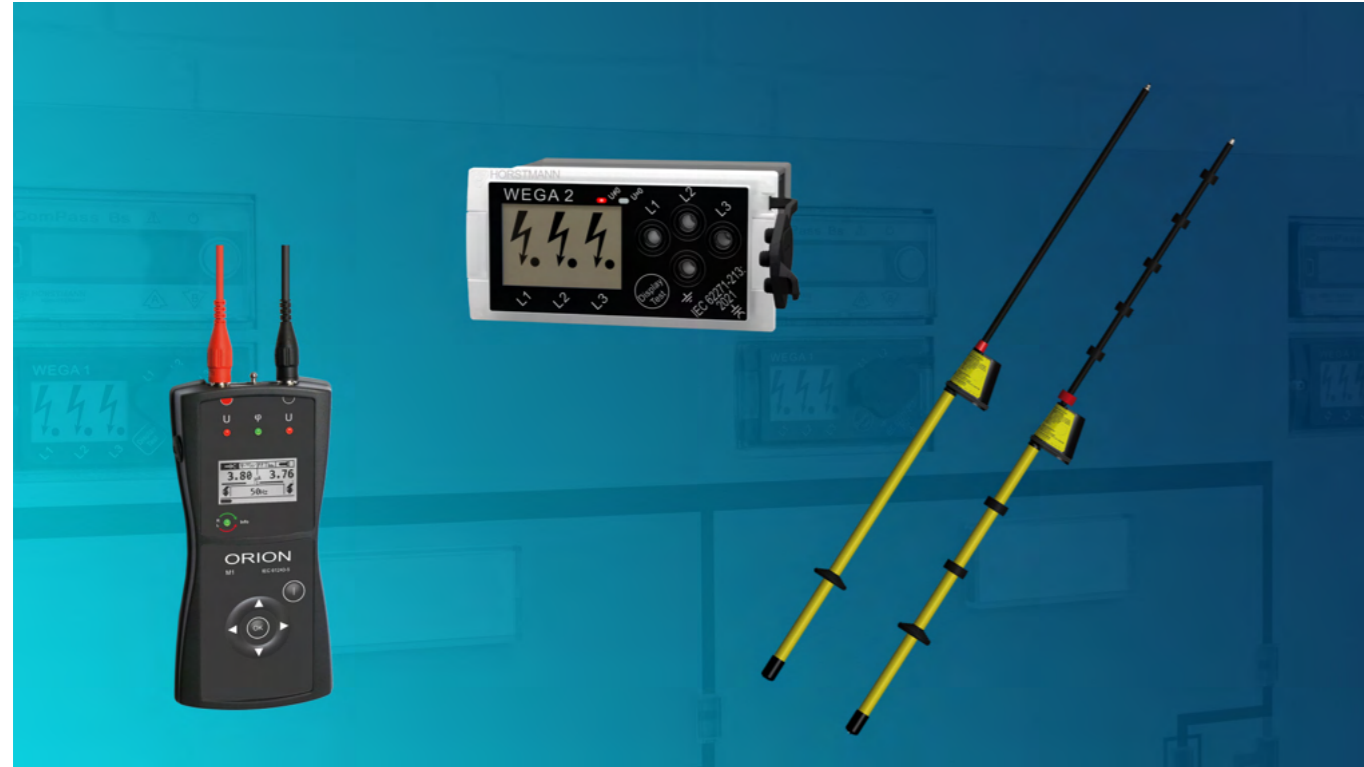

Is the system live or not? This is an elementary question, but it is vital to have a definite answer when service or maintenance staff are working on switchgears, power lines and electrical systems. In so doing, it is absolutely imperative to ensure that devices are only used for their approved nominal voltage and nominal frequency.

Voltage detectors and phase comparators

- ▶ For indoor and outdoor checks
- ▶ Visual and audible signals
- ▶ Highest safety thanks to self-test feature on selected models

Capacitive voltage detecting systems

Capacitive voltage detection systems (VDIS = Voltage Detecting and Indicating System) can be categorised into groups. In the case of plug-in systems, a portable indicating device (e.g. LRM-ST) is connected via an interface (e.g. LRM sockets) to the permanently installed part of the VDIS system (e.g. socket module).

In contrast, the integrated systems (type Wega) are permanently installed or can be retrofitted. They comprise the permanent voltage indication and are equipped with either an LRM interface or a measurement point for phase comparison. Thanks to the additional feature of a permanently supervised interface conditions displayed, no extra maintenance tests are required for these devices.

The Orion series: Orion 3.1 and M1 are portable testing devices that allow technicians to carry out on-site voltage detection, phase comparison and interface checks.

Product matrix

Integrated voltage detecting systems



Function	Wega 1	Wega 1 V	Wega 2	Wega 2 V	Wega 1 LV	Wega T1
VDIS according to IEC 62271-213	■	■	■	■	—	—
Capacitive voltage coupling for ComPass B series and Sigma D series	■	■	■	■	■	Connection to transformer
Overvoltage indication	■	■	■	■	—	■
Integrated permanent maintenance test	■	■	■	■	■	■
Integrated display test (without auxiliary supply)	■	■	■	■	■	■
Fully enclosed electronics	■	■	■	■	■	■
Adjustable C2 capacity	—	■	—	■	—	Vario variant
Assembly set for retrofit	—	■	—	—	—	■
Nominal voltage / nominal frequency						
Nominal voltage of switchgear	from 1 kV	from 1 kV	from 1 kV	from 1 kV	400-700 V	from 1 kV
Nominal frequency 50 Hz / 60 Hz	■	■	■	■	50 Hz	■
Display						
LCD display / LED indication	■ / —	■ / —	■ / ■	■ / ■	■ / —	■ / —
Display powered by measured voltage	■	■	■	■	■	■
LCD symbols						
Voltage present	■	■	■	■	■	■
Threshold value: 0.1 — 0.45 x Vnom	■	■	■	■	■	■
Interface						
Front accessible, fully featured LRM interface, also in compliance with LRM system according to IEC 61243-5	■	■	■	■	■	Test point
Communication						
Relay contacts	—	—	■	■	—	—
Connections						
Flat connector	■	■	■	—	■	■
System connector (AMP)	■	■	■	■	■	Vario variant
Power supply						
External auxiliary supply	—	—	■	■	—	—

Wega 1

Integrated voltage detecting system



Front view

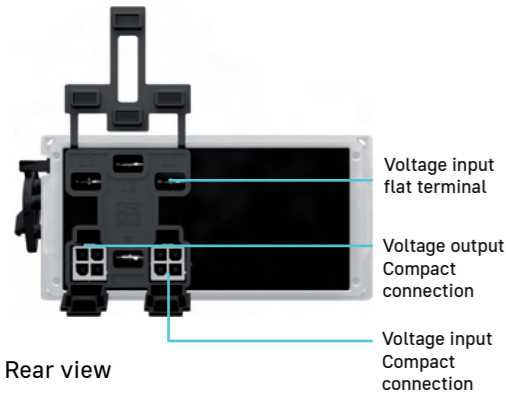

Rear view

PRODUCT FEATURES

- ▶ According to the current IEC 62271-213:2021 standard
- ▶ Tool-free assembly and disassembly: saves time
- ▶ Integrated maintenance test: maintenance-free
- ▶ Retrofit ready: capacitive connection to ComPass B and Sigma D series
- ▶ Fully encapsulated electronics: high functional reliability
- ▶ Extended temperature range from -40°C to +75°C: increased application possibilities
- ▶ High display contrast: improved readability
- ▶ Overvoltage display: phase-selective
- ▶ LRM interface on the front: fully compliant with IEC 62271-213:2021

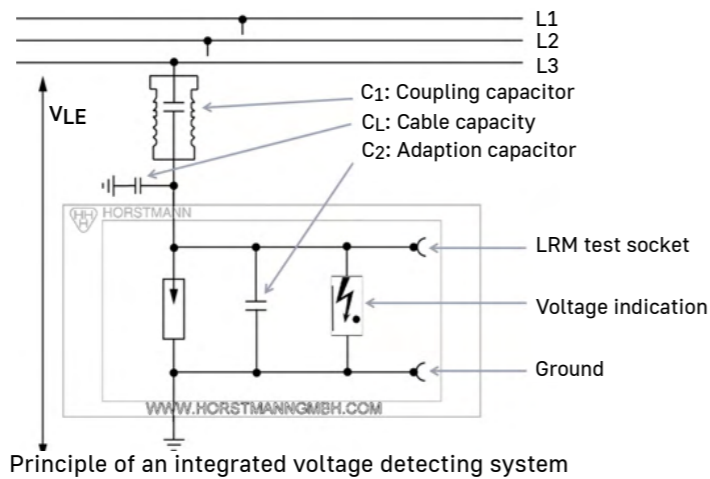

Wega 1 is a three-phase voltage detecting system that indicates subsequent medium voltage conditions:

- Voltage present
Threshold values for voltage presence indication: $0.1 - 0.45 \times V_{nom}$
- Voltage present
Integrated maintenance test passed
- Voltage present
Integrated maintenance test passed
Voltage signal too high (overvoltage indication)
- Voltage not present

The built-in display test function at the front enables verification of the display of the installed and de-energised unit. For connection, either shielded or unshielded cables with flat connectors or system connectors (AMP) can be used.

Technical data	Wega 1
Nominal voltage	1–52 kV (nominal voltage of switchgear, further values on request)
Nominal frequency	50–60 Hz
Interface	<ul style="list-style-type: none"> ▶ 3 LRM measuring sockets (one per phase) and 1 earth socket ▶ LRM system, 14 mm distance between sockets, with captive anti-dust cap
Indication	LCD display with arrow, dot and wrench tool
Power supply	<ul style="list-style-type: none"> ▶ No auxiliary supply needed ▶ LCD display: fed by measuring voltage
Input/ Output	Input: flat terminal or compact connection (AMP) Output: compact connection (AMP)
Housing	Polycarbonate, IP54
Temperature range	-40 °C to +75 °C

ABB	Switchgear	Switchgear panel	Voltage range	Order no.
	SafeRing / SafePlus	Cable / transformer / circuit breaker	10–24 kV	V51-1800-120-400

Driescher	Switchgear	Switchgear panel	Voltage range	Order no.
	Minex / Minex-C	Cable / transformer / circuit breaker	10–20 kV	51-1800-148

Eaton	Switchgear	Switchgear panel	Voltage range	Order no.
	XIRIA	Cable / transformer / circuit breaker	10.0–17.5 kV	51-1800-125
	XIRIA	Cable / transformer / circuit breaker	13.8–24.0 kV	51-1800-129

Lucy Electric	Switchgear	Switchgear panel	Voltage range	Order no.
	Aegis Plus	Circuit breaker	10–24 kV	51-1800-131
	Aegis Plus	Switch	10–24 kV	51-1800-121

Ormazabal	Switchgear	Switchgear panel	Voltage range	Order no.
	ga / gae	Cable	10–20 kV	51-1800-121
	ga / gae	Transformer	10–20 kV	51-1800-101
	ga / gae	Circuit breaker 630	10–20 kV	51-1800-129
	ga / gae	Circuit breaker 1250	10–20 kV	51-1800-131
	ga / gae	Metering	10–20 kV	51-1800-133

Schneider	Switchgear	Switchgear panel	Voltage range	Order no.
	FBX	C, C1, T1, R, RE	10–24 kV	51-1800-122
	FBX	T2, CB	10–24 kV	51-1800-132
	RM6	Cable/ transformer	10–20 kV	51-1800-125

Siemens	Switchgear	Switchgear panel	Voltage range	Order no.
	8DJH	Cable / Transformer / Metering	10–21.5 kV	51-1800-142

Required connecting cable between Wega and directional fault indicator

Switchgear	Output Wega / Input indicator	Indicator	Cable length	Order no.
ABB Eaton Lucy Electric Ormazabal Schneider Siemens	AMP / AMP	Sigma D and ComPass B 2.0 series	300 mm	49-0509-180
ABB Eaton Lucy Electric Ormazabal Schneider (RM6) Siemens	AMP / 4-pole connector	ComPass B	300 mm	49-0509-007
Driescher	AMP / AMP	Sigma D and ComPass B 2.0 series	1,300 mm	49-0509-188
Driescher	AMP / 4-pole connector	ComPass B	1,300 mm	49-0509-024

Further switchgear types, manufacturer, voltage ranges and cable lengths on request.

Dimension drawing see on page 132 ff | M12

Wega 1 V

Integrated voltage detecting system



Front view

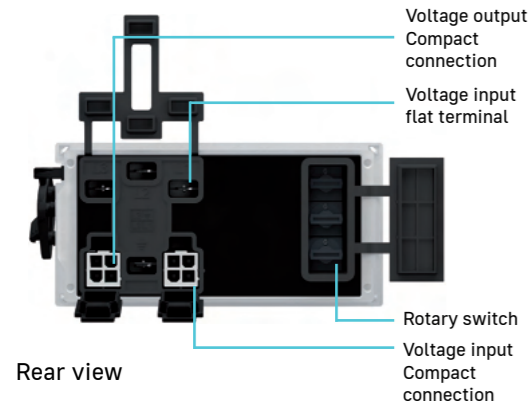





Rear view

PRODUCT FEATURES

- ▶ According to the current IEC 62271-213:2021 standard
- ▶ Tool-free assembly and disassembly: saves time
- ▶ Integrated maintenance test: maintenance-free
- ▶ Retrofit ready: capacitive connection to ComPass B and Sigma D series
- ▶ Fully encapsulated electronics: high functional reliability
- ▶ Extended temperature range from -40°C to +75°C: increased application possibilities
- ▶ High display contrast: improved readability
- ▶ Phase-selective rotary switches: quick and easy commissioning
- ▶ LRM interface on the front: fully compliant with IEC 62271-213:2021

Wega 1 V is a three-phase voltage detecting system that indicates subsequent medium voltage conditions:

-  Voltage present
Threshold values for voltage presence indication: 0.1 – 0.45 x V_{nom}
-  Voltage present
Integrated maintenance test passed
-  Voltage present
Integrated maintenance test passed
Voltage signal too high (overvoltage indication)
-  Voltage not present

The built-in display test function on the front allows the display to be tested when installed and de-energised.

Shielded or unshielded cables with compact connections (AMP) can be connected to the fault direction indicator. Fifteen different C2 settings can be made in a user-friendly manner via phase-selective rotary switches. The correct C2 setting is shown on the display (arrow and dot symbol without overvoltage indicator).

Technical data	Wega 1 V
Nominal voltage	1–52 kV (nominal voltage of switchgear, further values on request)
Nominal frequency	50–60 Hz
Interface	<ul style="list-style-type: none"> ▶ 3 LRM measuring sockets (one per phase) and 1 earth socket ▶ LRM system, 14 mm distance between sockets, with captive anti-dust cap
Indication	LCD display with arrow, dot and wrench tool
Power supply	<ul style="list-style-type: none"> ▶ No auxiliary supply needed ▶ LCD display: fed by measuring voltage
Input/ Output	Input: flat terminal or compact connection (AMP) Output: compact connection (AMP)
Housing	Polycarbonate, IP54
Temperature range	-40 °C to +75 °C

For retrofit projects, the following Wega 1 V variants can be connected directly to the C1 decoupler:

Switchgear	Voltage range	Order no.
ABB SafeRing/SafePlus; Driescher Minex, PSA10, PSA20; Ormazabal GAE; Schneider FBX, RM6, SM6; Siemens 8DJH, 8DA/DB (Innenkonus S2, S3, S4 & Poltragplatte), NX Plus	10 kV	51-1900-151

Switchgear	Voltage range	Order no.
ABB SafeRing/SafePlus; Driescher Minex, PSA10, PSA20; Ormazabal GAE; Schneider FBX, RM6, SM6; Siemens 8DJH, 8DA/DB (Inner cone S2, S3, S4 & Pole mounting plate), NX Plus	20 kV	51-1900-152

Universal solution for new installations and retrofit – Wega 1 V

Capacitor cube	Adjustable capacities	Input or output	Order no.
Low-Range	0, 100, 220, 320, 470, 570, 690, 790, 820, 920, 1040, 1140, 1290, 1390, 1510, 1610 pF	4 x Flat connector 2 x AMP	51-1900-101
Mid-Range	0, 1,5, 3,3, 4,8, 6,8, 8,3, 10,1, 11,6, 15,0, 16,5, 18,3, 19,8, 21,8, 23,3, 25,1, 26,6 nF	4 x Flat connector 2 x AMP	51-1900-102
High-Range	0, 22, 33, 55, 68, 90, 101, 123, 68, 90, 101, 123, 136, 158, 169, 191 nF	4 x Flat connector 2 x AMP	51-1900-103

Further Vario variants on request.

Required connecting cable between Wega and directional fault indicator

Switchgear	Output Wega / Input indicator	Indicator	Cable length	Order no.
ABB Eaton Lucy Electric Ormazabal Schneider Siemens	AMP / AMP	Sigma D and ComPass B 2.0 series	300 mm	49-0509-180
ABB Eaton Lucy Electric Ormazabal Schneider (RM6) Siemens	AMP / 4-pole connector	ComPass B	300 mm	49-0509-007
Driescher	AMP / AMP	Sigma D and ComPass B 2.0 series	1,300 mm	49-0509-188
Driescher	AMP / 4-pole connector	ComPass B	1,300 mm	49-0509-024

Further voltage ranges and cable lengths of the connecting cables on request.

Dimension drawing see on page 132 ff | M12 

Wega 1 V to HR interfaces | Retrofit of HR socket modules



Equipment set	Order no.
1 Wega mounting kit incl. housing, magnet, connecting cables	
300 mm Cable	51-1550-900
500 mm Cable	51-1550-901

Further cable lengths on request.

Integrated voltage detecting system



Front view

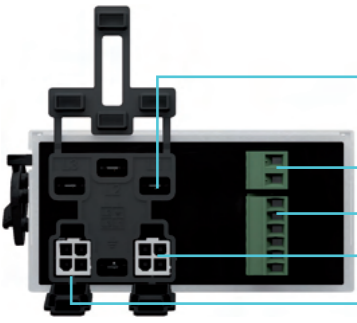

Rear view

- Voltage input flat terminal
- Auxiliary power supply
- Relay contacts
- Voltage input Compact connection
- Voltage output Compact connection

PRODUCT FEATURES

- ▶ According to the current IEC 62271-213:2021 standard
- ▶ Tool-free assembly and disassembly: saves time
- ▶ Integrated maintenance test: maintenance-free
- ▶ Retrofit ready: capacitive connection to ComPass B and Sigma D series
- ▶ Fully encapsulated electronics: high functional reliability
- ▶ Extended temperature range from -40°C to +75°C: increased application possibilities
- ▶ High display contrast: improved readability
- ▶ Overvoltage display: phase-selective
- ▶ LRM interface on the front: fully compliant with IEC 62271-213:2021

Wega 2 is a three-phase voltage detecting system that indicates subsequent medium voltage conditions:

- Voltage present
Threshold values for voltage presence indication: 0.1 – 0.45 x Vnom
- Voltage present
Integrated maintenance test passed
- Voltage present
Integrated maintenance test passed
Voltage signal too high (overvoltage indication)
- Voltage not present

The display test function built into the front allows the display to be tested when installed and de-energised.

Shielded or unshielded cables with compact connections can be connected to the fault direction indicator. Fifteen different C2 settings can be made in a user-friendly manner via phase-selective rotary switches. The correct C2 setting is shown on the display (arrow and dot symbol without overvoltage indicator).

Technical data	Wega 2
Nominal voltage	1–52 kV (nominal voltage of switchgear, further values on request)
Nominal frequency	50–60 Hz
Interface	<ul style="list-style-type: none"> ▶ 3 LRM measuring sockets (one per phase) and 1 earth socket ▶ LRM system, 14 mm distance between sockets, with captive anti-dust cap
Indication	<ul style="list-style-type: none"> ▶ LCD display with arrow, dot and wrench tool ▶ LED display, U=0 and U≠0
Remote signalling	2 alternating relay contacts
Power supply	<ul style="list-style-type: none"> ▶ LCD display: fed by measuring voltage ▶ Relay and LEDs via 24–230 V AC/DC power supply
Input/ Output	Input: flat terminal or compact connection (AMP) Output: compact connection (AMP)
Housing	Polycarbonate, IP54
Temperature range	-40 °C to +75 °C

The following variants are only for new installations.

ABB			
Switchgear	Switchgear panel	Voltage range	Order no.
SafeRing / SafePlus	Cable / Transformer / Circuit breaker	10–24 kV	51-2800-105
Driescher			
Switchgear	Switchgear panel	Voltage range	Order no.
Minex / Minex-C	Cable / Transformer / Circuit breaker	10–20 kV	51-2800-143
Eaton			
Switchgear	Switchgear panel	Voltage range	Order no.
XIRIA	Cable / Transformer / Circuit breaker	10,0–17,5 kV	51-2800-116
XIRIA	Cable / Transformer / Circuit breaker	13.8–24,0 kV	51-2800-119
Ormazabal			
Switchgear	Switchgear panel	Voltage range	Order no.
ga / gae	Cable	10–20 kV	51-2800-115
ga / gae	Transformer	10–20 kV	51-2800-106
ga / gae	Circuit breaker 630	10–20 kV	51-2800-119
ga / gae	Circuit breaker 1250	10–20 kV	51-2800-134
Schneider			
Switchgear	Switchgear panel	Voltage range	Order no.
FBX	C, C1, T1, R, RE	10–24 kV	51-2800-136
FBX	T2, CB	10–24 kV	51-2800-139
RM6	Cable / Transformer	10–20 kV	51-2800-116
Siemens			
Switchgear	Switchgear panel	Voltage range	Order no.
8DJH	Cable / Transformer / Metering	10-21,5 kV	51-2800-124

Required connecting cable between Wega and directional fault indicator

Switchgear	Output Wega / Input indicator	Indicator	Cable length	Order no.
ABB				
Eaton				
Lucy Electric	AMP / AMP	Sigma D and ComPass B 2.0 series	300 mm	49-0509-180
Ormazabal				
Schneider				
Siemens				
ABB				
Eaton				
Lucy Electric	AMP / 4-pole connector	ComPass B	300 mm	49-0509-007
Ormazabal				
Schneider (RM6)				
Siemens				
Driescher	AMP / AMP	Sigma D and ComPass B 2.0 series	1,300 mm	49-0509-188
Driescher	AMP / 4-pole connector	ComPass B	1,300 mm	49-0509-024

Further voltage ranges and cable lengths of the connecting cables on request.

Dimension drawing see on page 132ff | M13

Wega 2 V

Integrated voltage detecting system



Front view

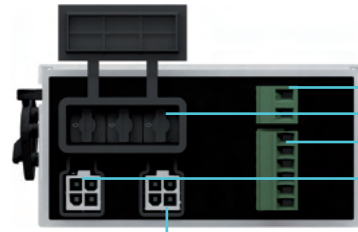

Rear view

- Auxiliary power supply
- Rotary switch
- Relay contacts
- Voltage output Compact connection
- Voltage input Compact connection

PRODUCT FEATURES

- ▶ According to the current IEC 62271-213:2021 standard
- ▶ Tool-free assembly and disassembly: saves time
- ▶ Integrated maintenance test: maintenance-free
- ▶ Retrofit ready: capacitive connection to ComPass B and Sigma D series
- ▶ Fully encapsulated electronics: high functional reliability
- ▶ Extended temperature range from -40°C to +75°C: increased application possibilities
- ▶ High display contrast: improved readability
- ▶ Phase-selective rotary switches: quick and easy commissioning
- ▶ Two independently current-carrying relay contacts: secure remote signalling and locking options
- ▶ LRM interface on the front: fully compliant with IEC 62271-213:2021

Wega 2 V is a three-phase voltage detecting system that indicates subsequent medium voltage conditions:

- Voltage present
Threshold values for voltage presence indication: 0.1 – 0.45 x V_{nom}
- Voltage present
Integrated maintenance test passed
- Voltage present
Integrated maintenance test passed
Voltage signal too high (overvoltage indication)
- Voltage not present

The built-in display test function on the front allows the display to be tested when installed and de-energised. Shielded or unshielded cables with compact connections can be connected to the fault direction indicator. Fifteen different C2 settings can be made in a user-friendly manner via phase-selective rotary switches. The correct C2 setting is shown on the display (arrow and dot symbol without overvoltage indicator).

The voltage status of the system panel can be signalled remotely or used for interlocking purposes via two independent relay contacts. The additional LEDs (green: V = 0 and red: V ≠ 0) provide information about the relay switch positions.

Technical data	Wega 2 V
Nominal voltage	1 – 52 kV (nominal voltage of switchgear, further values on request)
Nominal frequency	50 – 60 Hz
Interface	<ul style="list-style-type: none"> ▶ 3 LRM measuring sockets (one per phase) and 1 earth socket ▶ LRM system, 14 mm distance between sockets, with captive anti-dust cap
Indication	<ul style="list-style-type: none"> ▶ LCD display with arrow, dot and wrench tool ▶ LED display, U=0 and U≠0
Remote signalling	2 alternating relay contacts
Power supply	<ul style="list-style-type: none"> ▶ LCD display: fed by measuring voltage ▶ Relay and LEDs via 24 – 230 V AC/DC power supply
Input/ Output	Input: compact connection (AMP) Output: compact connection (AMP)
Housing	Polycarbonate, IP54
Temperature range	-40 °C to +75 °C

Universal solution for new installations and retrofit – Wega 2 V

Capacitor cube	Adjustable capacities	Input or output	Order no.
Low-Range	0, 100, 220, 320, 470, 570, 690, 790, 820, 920, 1040, 1140, 1290, 1390, 1510, 1610 pF	4 x Flat connector 2 x AMP	51-2900-101
Mid-Range	0, 1,5, 3,3, 4,8, 6,8, 8,3, 10,1, 11,6, 15,0, 16,5, 18,3, 19,8, 21,8, 23,3, 25,1, 26,6 nF	4 x Flat connector 2 x AMP	51-2900-102
High-Range	0, 22, 33, 55, 68, 90, 101, 123, 68, 90, 101, 123, 136, 158, 169, 191 nF	4 x Flat connector 2 x AMP	51-2900-103

Further Vario variants on request.

Switchgear	Switchgear panel	Voltage range	Input or output	Order no.
XIRIA	Cable / Transformer / Circuit breaker	10,0 – 17,5 kV	Flat connector / AMP	51-2250-116
XIRIA	Cable / Transformer / Circuit breaker	13,8 – 24,0 kV	Flat connector / AMP	51-2250-119

Required connecting cable between Wega and directional fault indicator

Switchgear	Output Wega / Input indicator	Indicator	Cable length	Order no.
ABB Eaton Lucy Electric Ormazabal Schneider Siemens	AMP / AMP	Sigma D and ComPass B 2.0 series	300 mm	49-0509-180
ABB Eaton Lucy Electric Ormazabal Schneider (RM6) Siemens	AMP / 4-pole connector	ComPass B	300 mm	49-0509-007
Driescher	AMP / AMP	Sigma D and ComPass B 2.0 series	1,300 mm	49-0509-188
Driescher	AMP / 4-pole connector	ComPass B	1,300 mm	49-0509-024

Further voltage ranges and cable lengths of the connecting cables on request.

Dimension drawing see on page 132 ff | M13

Accessories



	Order no.
AMP flat plug adapter cable set Enables the C1 decoupling to be connected to a Wega 2 V via a flat plug	49-5090-110

Wega 1 LV

Integrated voltage detecting system for low-voltage applications



Front view

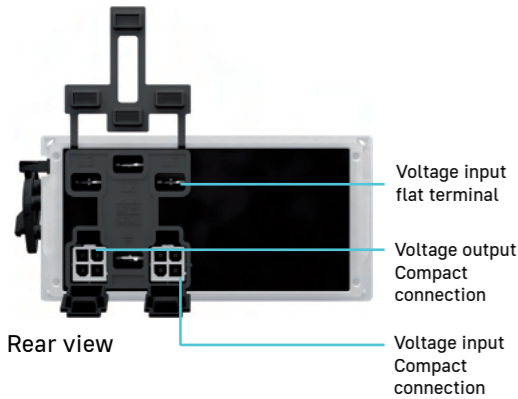

Rear view

PRODUCT FEATURES

- ▶ According to the current IEC 62271-213:2021 standard
- ▶ Tool-free assembly and disassembly: saves time
- ▶ Integrated maintenance test: maintenance-free
- ▶ Retrofit ready: capacitive connection to ComPass B and Sigma D series
- ▶ Fully encapsulated electronics: high functional reliability
- ▶ Extended temperature range from -40°C to +75°C: increased application possibilities
- ▶ High display contrast: improved readability
- ▶ Overvoltage display: phase-selective
- ▶ LRM interface on the front: fully compliant with IEC 62271-213:2021

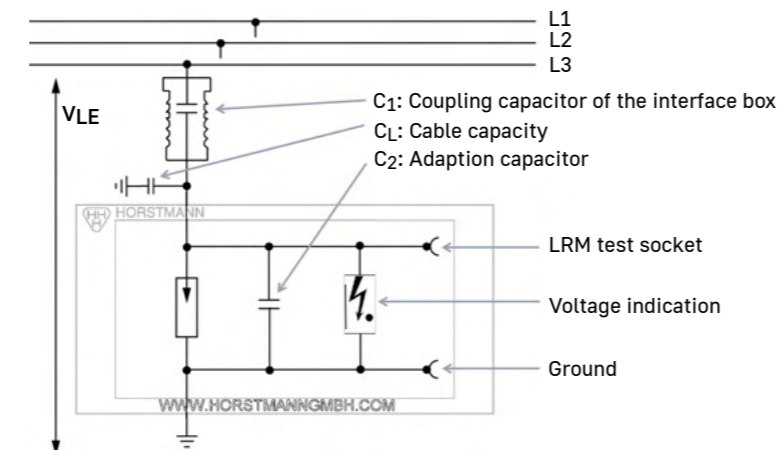

Principle of an integrated voltage detecting system for low-voltage applications

Wega 1 LV is a three-phase voltage detecting system that indicates low-voltage conditions:

	Voltage present Threshold value for voltage presence indication: 50 V
	Voltage present Integrated maintenance test passed
	Voltage not present

The Wega 1 LV is an integrated voltage indication system. The device is used to determine and display the operating status of three-phase low-voltage systems (without neutral conductor) in accordance with IEC 62271-213. The Wega 1 LV is based on the requirements for voltage detection and indication systems (VDIS) in accordance with IEC 62271-213, with the exception that IEC 62271-213 applies to rated voltages greater than 1 kV and that the Wega 1 LV has been designed accordingly for low voltage. The Wega 1 LV may only be operated as a complete system in combination with the interface box included in the set and the corresponding connection cable. The display test function built into the front of the device enables the display to be tested in the installed and de-energised state.

Dimension drawing see on page 27ff | M13

Technical data	Wega 1 LV
Nominal voltage	400 – 700 V (nominal voltage of switchgear, further values on request)
Nominal frequency	50 Hz
Interface	<ul style="list-style-type: none"> ▶ 3 LRM measuring sockets (one per phase) and 1 earth socket ▶ LRM system, 14 mm distance between sockets, with captive anti-dust cap
Indication	LCD display with arrow, dot and wrench tool
Power supply	<ul style="list-style-type: none"> ▶ No auxiliary supply needed ▶ LCD display: fed by measuring voltage
Input/ Output	Input: flat terminal or compact connection (AMP) Output: compact connection (AMP)
Housing	Polycarbonate, IP54
Temperature range	-40 °C to +75 °C

Wega T1

For insulated medium-voltage transformers

PRODUCT FEATURES

- ▶ Voltage display system, designed according to IEC 62271-213:2021 and IEC 61243-5
- ▶ Continuous LCD indication: 3-phase
- ▶ Suitable for Euromold elbow connectors (K) 158 LR, (K) 152 SR and M 400 LR / G as well as Pfisterer MSCE 250 A with capacitive test points
- ▶ Integrated maintenance test: maintenance-free

The Wega T1 is a 3-phase voltage detector for insulated medium voltage transformers safe for touching. It is installed in a surface mount housing for applications in new and existing transformer stations. Besides conventional medium voltage transformers, these types are in particular ideally suited for insulated medium voltage transformers, or in transformer stations / buildings with more than one transformer.

The built-in display test function at the front enables verification of the display of the installed and de-energised unit.

The test points are not suitable for an LRM phase comparator due to the weak capacitive coupling which is associated with the specific application of the devices.

Wega T1 is a three-phase voltage detecting system that indicates subsequent medium voltage conditions:

- Voltage present
Threshold values for voltage presence indication: 0.1 – 0.45 x Vnom
- Voltage present
Integrated maintenance test passed
- Voltage present
Integrated maintenance test passed
Voltage signal too high (overvoltage indication)
- Voltage not present

Technical data	Wega T1
Nominal voltage	1 – 52 kV (nominal voltage of transformer, further values on request)
Nominal frequency	50 – 60 Hz
Interface	Test points (1 per phase) and one earth socket, with captive anti-dust cap
Indication	LCD display with arrow, dot and wrench tool
Power supply	<ul style="list-style-type: none"> ▶ No auxiliary supply needed ▶ LCD display: fed by measuring voltage
Housing	Polycarbonate, IP54
Temperature range	-25 °C to +65 °C

Euromold	Connector type	Voltage range	Order nr.*
	(K) 152 SR / (K) 158 LR / M 400 LR/G	6 – 12 kV	V51-1251-001-301
	(K) 152 SR / (K) 158 LR / M 400 LR/G	10 – 20 kV	V51-1251-001-302
	(K) 152 SR / (K) 158 LR / M 400 LR/G	20 – 36 kV	V51-1251-001-303

Connector type	Voltage range	Order nr.*
Cellpack CGS 250 A	10 – 15 kV	
Cellpack CWS 250 A	16 – 24 kV	
Nexans/Euromold (K)200LR/G/V	6 – 10 kV	
Nexans/Euromold (K)200SR/G/V	10 – 15 kV	V51-1252-001-001
TE/Raychem RSES-VD-525x	8 – 15 kV	
TE/Raychem RSSS-VD-525x	12 – 24 kV	

* Incl. wall-mounted housing, coaxial cable and earthing cable

Dimension drawing see on page 132 ff | M14



Front view



Example of installation

Orion 3.1 | Orion M1

Combined voltage detecting and indicating systems



Orion 3.1



Orion M1

PRODUCT FEATURES

- ▶ Designed according to IEC 61243-5 (VDE 0682-415)
- ▶ Voltage detector
- ▶ Phase comparator
- ▶ Interface detector
- ▶ Phase-sequence indicator with status RGB LED
- ▶ Orion M1 with additional functions
 - ▶ Voltage harmonics and interface current measurement
 - ▶ Phase angle measurement
 - ▶ LCD display
 - ▶ Measured data storage, readable
 - ▶ Data transmission via USB interface

Orion 3.1 and Orion M1 are testing and indication devices for voltage detecting, phase comparison and coupling part maintenance testing according to IEC 61243-5. They are used at LRM and HR interfaces in medium voltage switchgears.

The Orion M1 features a large LCD display with backlight. It allows easy reading of the measured values, e. g. interface current, phase angle and voltage harmonics (according to EN 50160). The integrated USB interface is used to retrieve the stored data results for further evaluation.

Besides the information on the next maintenance test and the indication of the battery status, the Orion M1 device provides the user with menu language options (German/English) and option of setting the power frequency (16.7Hz / 50Hz / 60Hz).

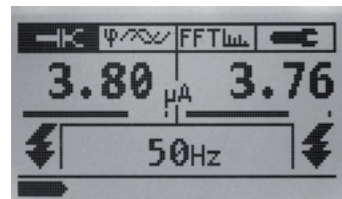

Indication capacitive interface

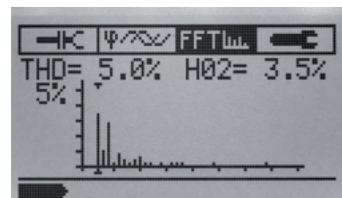

Indication harmonic waves

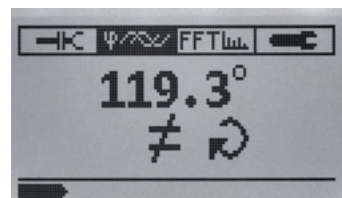

Indication phase comparison

Capacitive interface

- ▶ Precise current measurement in μA (2 x CH)
- ▶ Voltage testing symbols for both channels
- ▶ Maintenance tests
- ▶ Phase-sequence indication
- ▶ Frequency setting and battery status

Voltage accuracy

- ▶ FFT (Fast Fourier Transformation)
- ▶ Total harmonic distortion (THD) [%]
- ▶ Up to the 40th harmonic [%]
- ▶ Bar graph for voltage harmonics [%]

Phase characteristics

- ▶ Phase angle difference
- ▶ Phase balance / phase unbalance symbol
- ▶ Phase-sequence indication

According to the German accident prevention standard DGUV Regulation 3 (Table 1c), the device is subject to maintenance tests with minimum intervals of at least 6 years.

Technical data	Orion 3.1	Orion M1
Nominal frequency	50 or 60 Hz	16.7, 50, 60 Hz (adjustable)
Current measurement	—	Measuring range 1: 0–5 μA ($\pm 2\%$) Measuring range 2: 0–25 μA ($\pm 2\%$)
Phase angle measurement	—	Measuring range: -180° to $+180^\circ$ ($\pm 1^\circ$)
Harmonic voltage measurement	—	Bar graph: 0–5 % / 0–10 % THD: 0–100 % ($\pm 1\%$) Harmonic (2–40): 0–100 % ($\pm 1\%$)
Indication	RGB-LEDs	RGB LEDs LCD display
Power supply	▶ 4 mignon cells; replaceable ▶ 6 years of service life, 1,000 operating cycles/year	
Temperature range	-25 to $+55^\circ\text{C}$	-25 to $+55^\circ\text{C}$, below -15°C LED indication only



Orion 3.1	Nominal frequency	Order no.
1 indication unit incl. plastic case, set of measuring cables, 2 HR / LRM adapter	50 Hz	51-0206-101



Orion M1	Nominal frequency	Order no.
1 indication unit incl. plastic case, set of measuring cables, 2 HR / LRM adapter, USB cable, CD with application software	16,7, 50, 60 Hz	51-0206-201

Dimension drawing see on page 132 ff | M17

Accessories



LR-LRM adapter
Order no. 52-0206-002



Special adapter (HR / IVIS)
Set consists of 2 x red and 2 x black adapters Cable length approx. 0.1 m
Order no. 52-0206-017



Weva adapter Orion, 104 mm
Order no. 10 kV 52-0206-004
Order no. 20 kV 52-0206-005



Magnetic holder
Part of the Orion M1 set
Order no. 49-6001-010



Weva adapter Orion, 130 mm
Order no. 10 kV 52-0206-014
Order no. 20 kV 52-0206-024

Voltage indicator for capacitive measuring points



LRM-ST



HR-ST



Function tester HR/ LRM-ST

PRODUCT FEATURES

- ▶ LRM-ST: Voltage indicator for low-resistance modified systems, according to IEC 62271-213 und IEC 61243-5
- ▶ HR-ST: Voltage indicator for high-resistance systems, according to IEC 61243-5
- ▶ No battery supply - Low maintenance
- ▶ Fully encapsulated electronics - High functional reliability under all environmental conditions
- ▶ Gold-plated contacts - Long service life
- ▶ Voltage display via flashing LED
- ▶ Also suitable for permanent operation on socket modules

LRM-ST und HR-ST type voltage indicators are portable parts of a voltage detecting system with capacitive single-pole coupling to live parts.

The LRM/ HR function tester allows testing of the display and the overall function of the device.

According to the German accident prevention standard DGUV Regulation 3 (Table 1c), the device is subject to maintenance tests with minimum intervals of at least 6 years.



Example of application
Note: Our proven socket modules (BuMo 2.0) are available on request for switchgear manufacturers

Technical data	LRM-ST	HR-ST
Response voltage V_t	4–5 V	70–90 V
Nominal frequency	50 Hz	
Input impedance	2.0–2.4 M Ω	36.0–43.2 M Ω
Flash frequency	≥1 Hz upon trip voltage	
Circuit	Sealed in cast resin, water-proof	
Housing	Polycarbonate, IP 54	
Temperature range	–25 °C to +55 °C	

Equipment set	Order no.	Accessories	Order no.
LRM-ST	51-0205-011	Function tester	52-0211-007
HR-ST	51-0205-010		

Dimension drawing see on page 27ff | M15/ M16

Product matrix

Voltage detectors

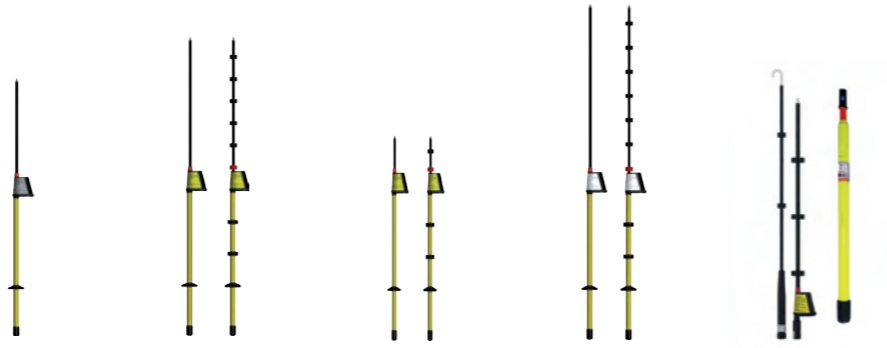

Function	FL-I	Comet BL-I / Comet BL-A	Comet BK-I / Comet BK-A	Comet BS-I / Comet BS-A	BO-A 2.0
Environmental conditions					
Indoor*	■	BL-I: ■	BK-I: ■	BS-I: ■	■
Indoor and outdoor**	—	BL-A: ■	BK-A: ■	BS-A: ■	■
Signalling					
Visual	■	■	■	■	■
Visual and audible	—	■	■	■	■
Further functions					
Self-test	—	■	■	■	■
Test principle: capacitive / resistive	■ / —	■ / —	■ / —	■ / —	■ / —
Voltage detection for Overhead lines	—	—	—	—	■
AC / DC	■ / —	■ / —	■ / —	■ / —	■ / —
Nominal voltage [kV]***					
0.1–3	—	—	—	—	—
5	—	■	—	—	—
6	■	—	—	—	—
10	■	■	—	—	—
11	—	■	—	—	■
15	—	—	—	—	■
20	■	■	—	—	—
25	—	—	—	—	■
30	—	■	—	—	—
5–10	—	■	—	■	—
6–10	—	■	■	—	—
10–20	—	■	■	■	—
20–30	—	■	—	■	—
20–36	—	—	—	—	—
Voltage range selectable	—	—	—	■	—
Technical data					
Length [mm]****	1,270–1,370	1,270–1,570	900–955	1,570	1,111–4,700
Weight [g]****	700–1,000	700–1,000	750–850	850–1,000	3,340

Product matrix

Voltage detectors / Phase comparators



Function	BO-A AC / DC	Compare 2.0	PG II
Environmental conditions			
Indoor*	■	■	■
Indoor and outdoor**	■	■	—
Signalling			
Visual	■	■	■
Visual and audible	■	—	—
Further functions			
Self-test	■	■	—
Test principle: capacitive / resistive	— / ■	■ / —	— / ■
Voltage detection for Overhead lines	■	■	■
AC / DC	■ / ■	■ / —	■ / —
Nominal voltage [kV]***			
0.1–3	■	—	—
5	—	—	■
6	—	—	■
10	—	—	■
11	—	—	—
15	—	—	—
20	—	—	■
25	—	—	—
30	—	—	■
5–10	—	■	—
6–10	—	—	—
10–20	—	■	—
20–30	—	—	■
20–36	—	■	—
Voltage range selectable	—	■	—
Technical data			
Length [mm]****	1,100–4,700	1,420	1,220–1,420
Weight [g]****	3,800–4,060	900	1,600

* Can be used outside, but not under wet conditions!

** Can be used under wet conditions.

*** Other voltage ranges on request.

**** Length and weight vary depending on the version.

Voltage detector without self-test



PRODUCT FEATURES

- ▶ Designed according to IEC 61243-1 (VDE 0682-411), Category S
- ▶ Indoor type 🏠
- ▶ Visual voltage indication 👁️
- ▶ No battery

The FL-I device is a voltage detector for testing the voltage on one pole. This device is designed to detect operating voltages clearly indicating either the “voltage present” or “voltage not present” state. This device does not have a built-in power source (battery) and thus no self-test function.

For transportation purposes, the insulating element can be removed from the display unit with the contact electrode.

According to the German accident prevention standard DGUV Regulation 3 (Table 1c), the device is subject to maintenance tests with minimum intervals of at least 6 years.

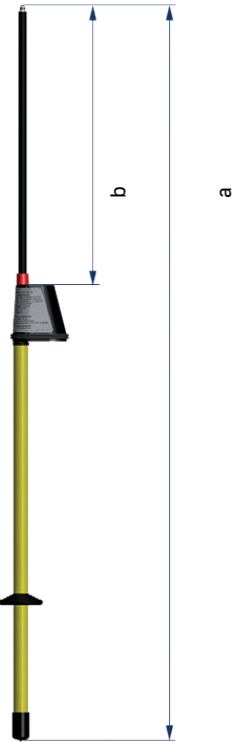

FL-I with indication unit

Technical data	FL-I
Application	In dry conditions, normally indoors
Indication	3 red LEDs
Nominal frequency	50 Hz (optional 60 Hz)
Operating temperature	-25 to +70 °C, climatic class N and W

Nominal voltage [kV]	Total length a [mm]	Insertion depth b [mm]	Order no.
6	1.270	463	50-1201-001
10	1.270	463	50-1201-002
20	1.370	563	50-1201-003

Accessories	Page
Extension rod	110
Contact tip	110
Storage bag/case	110

Voltage detector with self-test



PRODUCT FEATURES

- ▶ Designed according to IEC 61243-1 (VDE 0682-411), category S
- ▶ Comet BL-I: indoor type 🏠
- ▶ Comet BL-A: outdoor type 🏠🌧️
- ▶ Voltage indication visual 👁️ or visual 👁️ and audible 🔊
- ▶ Built-in self-test

The Comet BL-I / BL-A devices are capacitive voltage detectors for testing the voltage on one pole. They are intended for the detection of operating voltages clearly indicating either the “voltage present” or “voltage not present” state.

The voltage detectors are provided with a built-in self-test facility which checks the function of the circuit including the contact electrode (comprehensive self-test function) before each use.

For transportation purposes, the insulating element can be removed from the display with the contact electrode.

According to the German accident prevention standard DGUV Regulation 3 (Table 1c), the device is subject to maintenance tests with minimum intervals of at least 6 years.

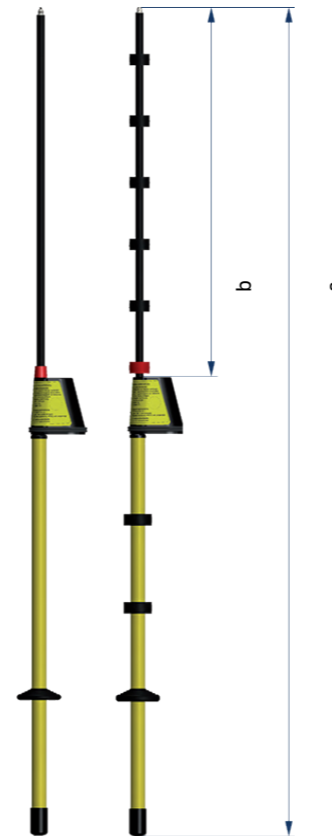

Comet BL-I | Comet BL-A with indication unit

Technical data	Comet BL-I	Comet BL-A
Application	In dry conditions, normally indoors	In dry and wet conditions, either indoors or outdoors
Indication	Visual: 1 red LED / 1 green LED Visual and audible: 1 red LED / 1 green LED / 1 buzzer	
Nominal voltage	50 Hz (optional 60 Hz)	
Power supply	2 lithium cells, battery service life: 6 years based on 10 ready-to-operate cycles per day for a total of 230 work days per year	
Operating temperature	-25 to +70 °C, climatic class N and W	

Nominal voltage [kV]	Total length a [mm]	Insertion depth b [mm]	Order no.			
			Comet BL-I 🏠	Comet BL-I 🏠🔊	Comet BL-A 🏠	Comet BL-A 🏠🔊
5	1,270	462	50-0901-011	50-0903-008	50-1001-009	50-1003-009
10	1,270	462	50-0901-012	50-0903-009	50-1001-010	50-1003-010
20	1,420	612	50-0901-013	50-0903-010	50-1001-011	50-1003-011
6–10	1,420	612	50-0901-014	50-0903-011	50-1001-012	50-1003-012
10–20	1,570	762	50-0901-015	50-0903-012	50-1001-013	50-1003-013
20–30	1,570	762	50-0901-022	50-0903-018	50-1001-015	50-1003-018

Accessories	Page
Extension rod	110
Contact tip	110
Double prong adapter	110
Storage bag/case	110

Comet BK-I | Comet BK-A

Voltage detector with self-test



PRODUCT FEATURES

- ▶ Designed according to IEC 61243-1 (VDE 0682-411), category S
- ▶ Comet BK-I: indoor type 🏠
- ▶ Comet BK-A: outdoor type 🏠 ☔
- ▶ Voltage indication visual 👁️ or visual 👁️ and audible 🔊
- ▶ Shortened design
- ▶ Built-in self-test

The Comet BK-I / BK-A devices are capacitive voltage detectors for testing the voltage on one pole in short version. They are intended for the detection of operating voltages clearly indicating either the “voltage present” or “voltage not present” state.

The voltage detectors are provided with a built-in self-test facility which checks the function of the circuit including the contact electrode (comprehensive self-test function) before each use.

For transportation purposes, the insulating element can be removed from the display with the contact electrode.

According to the German accident prevention standard DGUV Regulation 3 (Table 1c), the device is subject to maintenance tests with minimum intervals of at least 6 years.

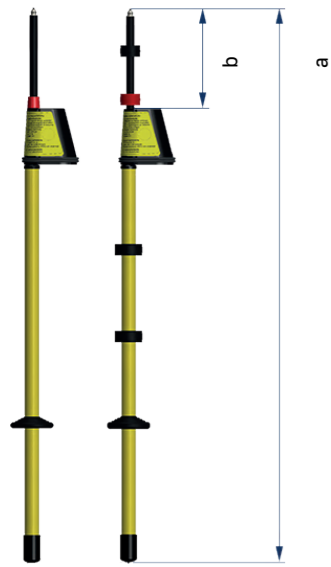

Comet BK-I | Comet BK-A with indication unit

Technical data	Comet BK-I	Comet BK-A
Application	In dry conditions, normally indoors	In dry and wet conditions, either indoors or outdoors
Indication	▶ Visual: 1 red LED / 1 green LED ▶ Visual and audible: 1 red LED / 1 green LED / 1 buzzer	
Nominal voltage	50 Hz (optional 60 Hz)	
Power supply	2 lithium cells, battery service life: 6 years based on 10 ready-to-operate cycles per day for a total of 230 work days per year	
Operating temperature	-25 to +70 °C, climatic class N and W	

Nominal voltage [kV]	Total length a [mm]	Insertion depth b [mm]	Order no.			
			Comet BK-I 🏠	Comet BK-A 🏠 ☔	Visual	Visual & Audible
6-10	900	110	50-1301-001	50-1401-001	50-1303-001	50-1403-001
10-20	950	210	50-1301-002	50-1401-002	50-1303-002	50-1403-002

Accessories	Page
Extension rod	110
Contact tip	110
Double prong adapter	110
Storage bag/case	110

Comet BS-I | Comet BS-A

Voltage detector with self-test, voltage range selector



PRODUCT FEATURES

- ▶ Designed according to IEC 61243-1 (VDE 0682-411), category S
- ▶ Voltage detector for nominal voltages from 5–30 kV, switchable
- ▶ Comet BS-I: indoor type 🏠
- ▶ Comet BS-A: outdoor type 🏠 ☔
- ▶ Voltage indication visual 👁️ or visual 👁️ and audible 🔊
- ▶ Built-in self-test

Comet BS-I / BS-A devices are switchable single-pole voltage detectors. They are designed to detect operating voltages clearly indicating the “voltage present” or “voltage not present” state.

The voltage detectors are provided with a built-in self-test facility which checks the function of the circuit including the contact electrode (comprehensive self-test function) before each use.

The turning knob is used to select between three nominal voltage ranges:

- 0: OFF
- 1: 5–10 kV
- 2: 10–20 kV
- 3: 20–30 kV

For transportation purposes, the insulating element can be removed from the display unit with the contact electrode.

According to the German accident prevention standard DGUV Regulation 3 (Table 1c), the device is subject to maintenance tests with minimum intervals of at least 6 years.

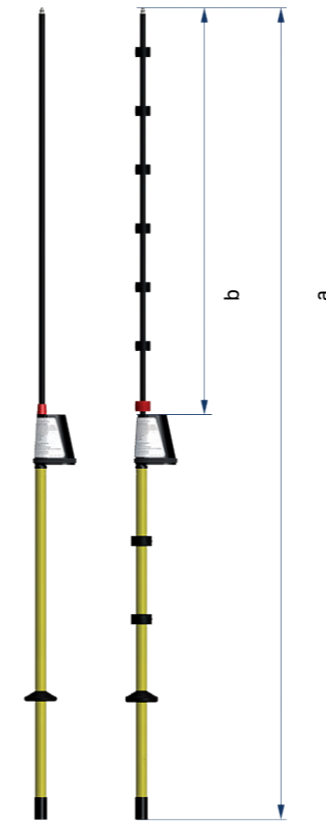

Comet 2.0 BS-I | Comet 2.0 BS-A with indication unit

Technical data	Comet BS-I	Comet BS-A
Application	In dry conditions, normally indoors	In dry and wet conditions, either indoors or outdoors
Indication	Visual: 1 red LED / 1 green LED Visual and audible: 1 red LED / 1 green LED / 1 buzzer	
Nominal voltage	50 Hz (optional 60 Hz)	
Power supply	2 lithium cells, battery service life: 6 years based on 10 ready-to-operate cycles per day for a total of 230 work days per year	
Operating temperature	-25 to +70 °C, climatic class N and W	

Nominal voltage [kV]	Total length a [mm]	Insertion depth b [mm]	Order no.			
			Comet BL-I 🏠	Comet BL-A 🏠 ☔	Visual	Visual & Audible
5-30	1,570	758	50-0921-001	50-1021-001	50-0923-001	50-1023-001

Accessories	Page
Extension rod	110
Contact tip	110
Double prong adapter	110
Storage bag/case	110

BO-A 2.0

For railway overhead contact lines



BO-A 2.0 plug-in adapter, telescopic rod | Display

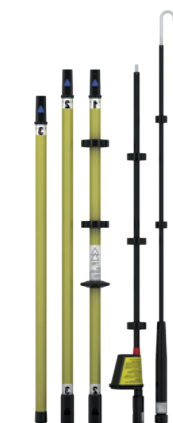

BO-A 2.0 with insulating rods (plug-in)

PRODUCT FEATURES

- ▶ VDE version — according to DIN VDE 0681-6
IEC version — based on IEC 61243-1 category S
- ▶ Pluggable system — minimal setup
- ▶ Integrated self-test — greater safety
- ▶ Light weight — easy handling and transportation
- ▶ Length of 4.7 m — voltage detection from the ground
- ▶ Use even in precipitation
- ▶ Storage bag - safe transport

The BO-A 2.0 is a voltage detector for medium voltage railway overhead contact lines. It is designed to detect the absence or presence of voltage during maintenance work for example. The voltage detector BO-A 2.0 is developed for 16.7 Hz, 50 Hz and 60 Hz networks. If the voltage detector BO-A 2.0 is used in a network with a deviating frequency, a visual and audible signal is activated. In this case the network situation must be verified.

The BO-A 2.0 is designed according to IEC 61243-1 resp. VDE 0681-6, depending on the version. The voltage detector is ready for the world-wide market.

According to the German accident prevention standard DGUV Regulation 3 (Table 1c), the device is subject to maintenance tests with minimum intervals of at least 6 years.

Technical data	BO-A 2.0
Application	In dry and wet conditions
Indication	“Ready-to-operate state”: green LED (after passed self-test) “Voltage present”: red LED and audible signal “Voltage not present”: green LED and no audible signal
Period of “Stand-by state”	65 s ±15 s
Type of indication	According to group III IEC 61243-1
Nominal voltage / nominal frequency	VDE version: 11 kV / 16.7 Hz or 15 kV / 16.7 Hz IEC version: 15 kV / 16.7 Hz, 25 kV / 50 Hz or 25 kV / 60 Hz
Properties of the insulating rod	Passed test as insulating element for leakage current at 1.2 x Vr for 1 min
Power supply	Lithium cells, battery service life: 6 years based on 10 ready-to-operate cycles per day for a total of 230 work days per year
Transportation length	<1,111 mm
Minimum length insulating element	>520 mm
Operating temperature	-25 to +70 °C, climatic class N and W

Nominal voltage [kV]/ nominal frequency [Hz]	Total length a [mm]	Insertion depth b [mm]	Handling	Version	Order no.
15 kV / 16.7 Hz	max. 5,400	1,790	Telescopic rod / plug-in adapter	▶ VDE version ▶ DB approval	50-1510-202
15 kV / 16.7 Hz	max. 5,400	1,790	Telescopic rod / plug-in adapter	▶ IEC version ▶ Automatic self-activation	50-1512-002
15 kV / 16.7 Hz	4,700	1,790	Insulating rods (plug-in)	▶ VDE version ▶ DB approval	50-1510-002
11 kV / 16.7 Hz	4,700	1,790	Insulating rods (plug-in)	▶ VDE version ▶ Automatic self-activation	50-1510-301

Further versions are available depending on the following parameters:

- ▶ Nominal voltage (11 kV, 15 kV, 25 kV),
- ▶ Rated frequency (16.7 Hz, 50 Hz, 60 Hz),
- ▶ Version according to IEC 61243-1 or VDE 0681-6,
- ▶ Handle (telescopic rod/plug-in adapter, universal adapter/telescopic rod, plug-in insulating rod),
- ▶ Optional: Automatic self-activation when connected to live overhead lines.

Simply let us know which version is suitable for your application.

Accessories	Order no.
Transportation bag ¹⁾ , reflection orange	52-0104-106
Transportation bag ¹⁾ , reflection yellow	52-0104-107

¹⁾ Dimensions: 1,130 x 340 x 100 mm (L x H x D)



Transportation bag with BO-A 2.0



Pluggable system BO-A 2.0



Transport of one and two storage bags

BO-A AC/DC

DC voltage detector for overhead lines of electric railways



BO-A AC/DC plug-in adapter telescopic rod | Display



BO-A AC/DC with insulating rods (plug-in)

PRODUCT FEATURES

- ▶ Simple plug-in and telescopic system - quick and easy ready for use
- ▶ Integrated self-test + AC / DC residual voltage indicator - maximum safety
- ▶ Low weight - easy handling and transport
- ▶ Bright LEDs and loud acoustic signals - good visibility in all environmental conditions
- ▶ Shock-resistant and no battery replacement necessary - maintenance-free with long service life
- ▶ DC polarity indicator
- ▶ Can also be used in precipitation
- ▶ Up to max. 4.7 m in length - voltage test from the ground
- ▶ Magnetic earthing contact

The BO-A AC/DC mobile voltage detector is used to determine the absence of voltage on overhead lines. It recognises dangerous DC and AC residual voltages and thus increases user safety.

The BO-A AC/DC is a two-pole voltage tester for overhead lines on trams and electric buses, for example.

If the BO-A AC/DC is applied to a live conductor, an optical and acoustic signal is activated. A DC or AC voltage network is automatically recognised and indicated.

The BO-A AC/DC is designed and tested in accordance with the IEC 61243-1, -2 and DIN VDE 0681-6 standards. It can therefore be used worldwide.

In accordance with DGUV Regulation 3 (Table 1c), the device is subject to the periodic test prescribed every 6 years.

Technical data	BO-A AC/DC
Use	▶ DC and AC voltage networks from 100 V to 3,000 V ▶ Use in dry and wet conditions
Indication	'Stand-by': green LED (after successful self-test) 'Voltage present': red LED and acoustical signal for DC with static polarity indication (blue/red) for AC without polarity indication 'Voltage not present': green LED, no acoustical signal AC/DC residual voltage indicator: yellow flashing LED for: AC residual voltage detection from 50 V RMS or DC residual voltage detection from ±75V DC +_ polarity indicator: detecting DC voltage polarity: red or blue flashing LED
Period of „Stand-by state“	65 s ±15 s (Automatic self-activation optionally available)
Type of indication	According to group III IEC 61243-1
Nominal voltage / nominal frequency	The following three standard versions are available: ▶ Un = 100 V – 300 V ▶ Un = 300 V – 900 V ▶ Un = 1000 V – 3000 V See imprint on type plate, tolerance ± 10 % 16.7 – 60 Hz
Properties of the insulating stick	Passed test as insulating element for leakage current at 1.2 x Vr for 1 min
Power supply	Replaceable lithium cells, 6 years at approx. 10 ready cycles / day and 230 days / year
Transportation length	<1,100 mm (incl. hook)
Minimum length insulating element	>520 mm
Operating temperature	–25 °C to +65 °C

Nominal voltage [kV] Nominal frequency [Hz]	Total length [mm] ±50 mm	Version	Order no.
100–300 V (AC) / 50 Hz or DC	4,700	Telescopic pole /Plug adapter	50-1600-202
300–900 V (AC) / 50 Hz or DC	4,700	Telescopic pole /Plug adapter	50-1600-203
1000–3000 V (AC) / 50 Hz or DC	4,700	Telescopic pole /Plug adapter	50-1600-204
100–300 V (AC) / 50 Hz or DC	4,700	Telescopic pole /Universal adapter	50-1600-102
300–900 V (AC) / 50 Hz or DC	4,700	Telescopic pole /Universal adapter	50-1600-103
1000–3000 V (AC) / 50 Hz or DC	4,700	Telescopic pole /Universal adapter	50-1600-104
100–300 V (AC) / 50 Hz or DC	4,700	Insulating sticks (pluggable)	50-1600-002
300–900 V (AC) / 50 Hz or DC	4,700	Insulating sticks (pluggable)	50-1600-003
1000–3000 V (AC) / 50 Hz or DC	4,700	Insulating sticks (pluggable)	50-1600-004
1500 V DC (without residual and polarity display)	4,700	Telescopic pole /Plug adapter	50-1504-002

Telescopic pole/Plug-in system



	Order no.
Plug-in adapter/ telescopic insulating stick according to IEC 62193 and ASTM 1826	52-0108-051
Universal adapter/ telescopic insulating stick according to IEC 62193 and ASTM 1826	65-0305-001
Insulating stick (pluggable)	52-0108-008

Accessories	Page
Earthing bridge	110
Storage bag	110
Double prong adapter and catch fork	110

Compare 2.0

Phase comparator, single-pole

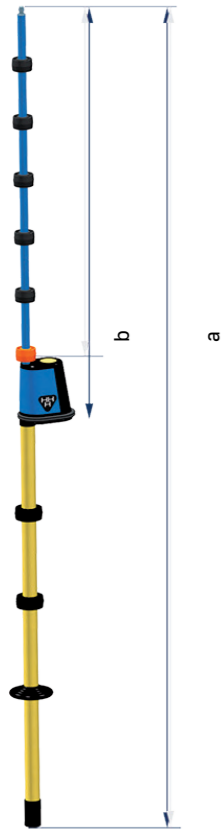

PRODUCT FEATURES

- ▶ Designed according to IEC 61481 (VDE 0682-431)
- ▶ Single-pole, capacitive phase comparator
- ▶ Detection of correct phase relationship and incorrect phase relationship between two live conductors
- ▶ For indoor and outdoor applications 🏠 ⚡
- ▶ Visual indication 👁️
- ▶ Built-in self-test function

The phase comparator Compare 2.0 is a single-pole, capacitive phase comparator for voltages from 5–36 kV. The device detects “correct phase relationship” or “incorrect phase relationship” conditions between two live conductors of a medium voltage distribution network.

Confirming to IEC 61481 Class B, “incorrect phase relationship” appears at a phase angle between 60° and 300°.

Four bright LEDs indicate various operational conditions.

The turning knob is used to select between three voltage ranges:

- 1: 5–10 kV
- 2: 10–20 kV
- 3: 20–36 kV

The phase comparison is realised by contacting the conductors one after the other.

In medium voltage networks with decentralised renewable energy feed-ins, measurement interruptions may occur. In such cases repeat the phase comparison. It is impossible to get a wrong indication.

According to the German accident prevention standard DGUV Regulation 3 (Table 1c), the device is subject to maintenance tests with minimum intervals of at least 6 years.

Compare 2.0 with indication unit

Technical data	Compare 2.0
Application	In dry and wet conditions, either indoors or outdoors
Indication	Visual: 1 white LED / 1 blue LED / 1 green LED / 1 red LED
Nominal frequency	50 Hz
Power supply	2 lithium cells, battery service life: 6 years based on 10 ready-to-operate cycles per day for a total of 230 work days per year
Operating class	B (indication of phase unbalance in the range of 60°–300°)
Operating temperature	-25 to +70 °C, climatic class N and W

Nominal voltage [kV]	Total length a [mm]	Insertion depth b [mm]	Order no.	Accessories	Page
5–36	1,420	635	51-0104-001	Storage bag	110

PG II

Phase comparator, two-pole

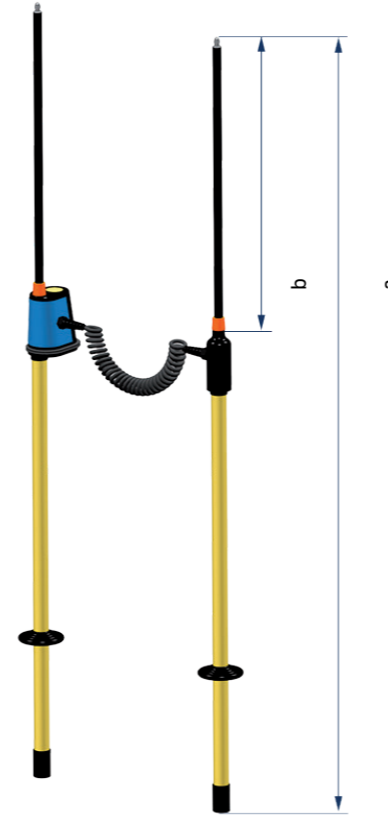

PRODUCT FEATURES

- ▶ Designed according to IEC 61481 (VDE 0682-431)
- ▶ Two-pole phase comparator
- ▶ Detection of correct phase relationship and incorrect phase relationship of two live conductors
- ▶ Indoor type 🏠
- ▶ Visual indication 👁️

PG II two-pole testing devices detect phase balance between two live conductors of a medium voltage distribution network.

The device consists of an operating stick with contact electrode and an indication unit (part A) as well as an operating stick with contact electrode (part B) to tap a comparative phase.

The insulated stick can be removed from the indication unit with the contact electrode.

Contact electrode A is directly connected with the contact electrode B using a helix cable suitable for high voltages.

According to the German accident prevention standard DGUV Regulation 3 (Table 1c), the device is subject to maintenance tests with minimum intervals of at least 6 years.

PG II with indication unit

Technical data	PG II
Application	In dry conditions, normally indoors
Indication	Visual: 3 red LEDs
Nominal frequency	50 Hz (optional 60 Hz)
Maximum operating period with the pole connected to voltage	60 s
Connection cable	1 m
Operational class	B (indication of phase unbalance in the range of 60°–300°)
Operating temperature	-25 to +70 °C, climatic class N and W

Nominal voltage [kV]	Total length a [mm]	Insertion depth b [mm]	Order no.	Accessories	Seite
5	1,220	413	51-0102-001	Storage bag	110
6	1,220	413	51-0102-002	Contact tip	110
10	1,220	413	51-0102-003		
20	1,320	513	51-0102-004		
30	1,420	613	51-0102-005		
5–10	1,220	413	51-0102-010		
10–12	1,220	413	51-0102-006		
15–24	1,320	513	51-0102-012		

Accessories

for voltage detectors and phase comparators

Transportation bag



For products	Dimensions [mm]		Order no.
	L	H	
FL-I, Comet BL-I / BL-A / BK-I / BK-A, Compare 2.0	900	200	52-0104-101
TP-I, Comet BS-I, Comet BS-A	1,080	220	52-0104-102

Universal plastic case



For products	Dimensions [mm]			Order no.
	L	H	D	
FL-I, TP-I, Comet series, Compare 2.0, PG II	1,030	240	100	52-0102-001

Extension rod

For extending the handle



For products	Length [mm]	Order no.
FL-I, Comet series, Compare 2.0, PG II	500	52-0108-013
FL-I, Comet series, Compare 2.0, PG II	1,000	52-0108-014

Contact tip

The tip provides improved penetration into oxide or paint layers



For products	Order no.
FL-I, Comet series, PG II, Compare 2.0	52-0306-002

Extension rod with contact electrode

For extending the insertion depth. It is not allowed to use the extension with contact electrode when it is wet.



For Products	Length [mm]	Effective Länge engh	Order no.
Comet Series	890	820	52-0106-015

Double prong adapter, Catch hook and Earthing bridge

The double prong adapter is designed to make it easier to contact overhead lines, while the catch hook is designed to hook the voltage detector onto overhead lines.



	Order no.
Catch hook, screw-on, for attaching to the overhead line (left)	52-0307-010
Double prong adapter, screw-on, for contacting or connecting to the overhead line from below (right)	52-0307-011



Earthing bridge for	Order no.
BO-A AC/DC	52-0108-052

Maintenance test

Voltage measuring devices

As per German accident prevention regulations for electrical installations and equipment (DGUV Regulation 3) of Employers Liability Insurance Association, voltage detectors, phase comparators and pluggable capacitive voltage detecting systems are subject to maintenance tests at intervals not exceeding 6 years. Dipl.-Ing. H. Horstmann GmbH offers this maintenance testing for all new but also for some older devices of own production.

Regardless of the duty to perform maintenance testing, the following rule is mandatory for devices and equipment including voltage detectors: The user is responsible for the safe and proper condition of the devices. Prior to each use, the user must verify devices and equipment are suitable for proper function as well as checking for externally visible damages and defects. Integrated capacitive voltage testing devices of the Wega series including Wega 1, Wega 1 V, Wega 2, Wega 2 V and Wega T1 with self-test facility, are not subject to maintenance tests.

Maintenance test on devices belonging to the AC and FGB series are no longer carried out. In exchange, we offer corresponding new devices.

	Testing requirements according to	Remark	Age ≤14 years Order no.	Age ≥14 years and ≤24 years Order no.
Voltage detectors with capacitive coupling a)				
BL-I, BL-A	DIN EN 61243-1 / VDE 0682 part 411	a), b), c)	79-0102-004	79-0102-006
BK-I, BK-A, BS-I, BS-A	DIN EN 61243-1 / VDE 0682 part 411	a), b), c)	79-0102-004	79-0102-007
BO-A 2.0	DIN VDE 0681 part 6	a), b), c)	79-0114-001	79-0114-005
BO-A AC/DC	DIN VDE 0682 part 6	a), b), c)	79-0114-001	79-0114-005
FL-I	DIN EN 61243-1 / VDE 0682 part 411	a), b)	79-0110-001	79-0110-005
Phase comparators with capacitive coupling				
PG	DIN EN 61481 / VDE 0682 part 431		79-0105-000	—
PG II	DIN EN 61481 / VDE 0682 part 431	a), b), c)	79-0105-001	79-0105-005
Compare 2.0	DIN EN 61481 / VDE 0682 part 431	a), b), c)	79-0112-001	79-0112-005
Interface detectors, voltage detectors, phase comparators, measurement modules				
Orion 3.1	DIN EN 61243-5 / VDE 0682 part 415	c)	79-0107-002	79-0107-005
Orion M1	DIN EN 61243-5 / VDE 0682 part 415	c)	79-0107-003	79-0107-006
Capacitive continuous voltage indicators, pluggable a)				
HR-ST, LRM-ST	DIN EN 61243-5 / VDE 0682 part 415	d)	—	—
Coupling parts of pluggable capacitive voltage detecting systems				
HR- or LRM interface (Alternatively: HR or LRM jack modules)	DIN EN 61243-5 / VDE 0682 part 415 (latest and newer devices)	e)	—	—

- All devices, which are sent to us by our customers, must be sent complete, including operating sticks and extension elements.
- We perform maintenance test only on the condition that the devices are not older than 24 years and in a technically acceptable condition. For devices with an age >14 and ≤24 years, an extended maintenance test will be performed, including electronics replacement.
- For all battery-operated devices, the battery replacement is mandatory during maintenance test (included in the price).
- Due to the disproportionately high testing expenditure, we do not carry out maintenance tests, but we offer "old" versus "new". Here we grant a special discount of 20 % on the new price if the old devices are sent back.
- Can be carried out on own initiative with the Orion 3.1, M1. Orion 3.1 conclude a good / bad condition. Further quantitative measurements can be carried out using Orion M1 well as appropriate digital multimeters.

In order to avoid any delay in processing order, we kindly ask you to either attach a copy of your order letter to your consignment, or send us your order letter in due time.



Earthing and short-circuiting devices with a reduced earth wire cross-section can be used in all networks without direct star point earthing (see IEC 61230 or VDE 0683-100). For networks with direct neutral earthing short-circuiting and earthing cable cross-sections must be the same.

Lengths of earthing and short-circuit cables have to fit to the switchgear and the distances between the connection points (min 1.2 times of the distance). If the cables are too long (>1.5 times of the distance) they must be fixed with an insulating cable to prevent damages and injuries in case of a short-circuit.

Current and time rating for earthing equipment

When selecting the required cable cross section, the maximum short-circuit current of the switchgear installation must be taken into account.

Earthing and short-circuiting devices and their components must be dimensioned in accordance with the short-circuit current rating (I_r), the short-circuit time rating (t_r) and the corresponding peak factor.

Earthing and short-circuiting devices can be connected in parallel to increase the rated currents. The requirements of VDE 0105-100 must be observed:

- ▶ Same cable length
- ▶ Same cable cross-sections
- ▶ Same connecting parts and connectors
- ▶ Installation of the devices close together with parallel routing of the cables
- ▶ 75 % of the permissible current carrying capacity must be assumed for each cable

Type testing refers basically to a rated time $t_r = 0.5$ s.

Cable cross section [mm ²]	Short-circuit time $t_r = 0.5$ s		Short-circuit time $t_r = 1.0$ s	
	Rated current I_r [kA]	Peak factor	Rated current I_r [kA]	Peak factor
16	4.5	2.5	3.2	3.5
25	7.0	2.5	4.9	3.5
35	10.0	2.5	6.9	3.5
50	14.0	2.5	9.9	3.5
70	19.5	2.5	13.8	3.5
95	26.5	2.5	18.7	3.5
120	33.5	2.5	23.7	3.5
150	42.0	2.5	29.6	3.5

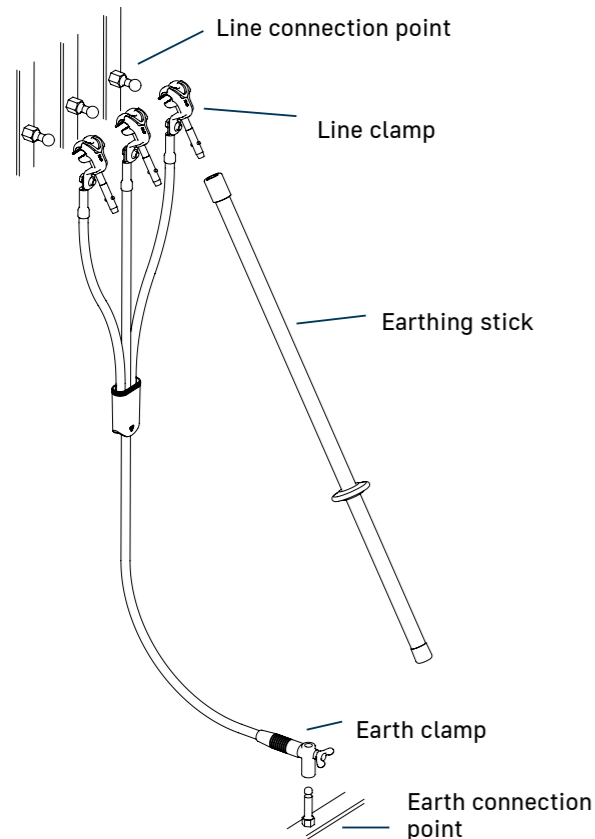

As a full-range supplier of medium voltage equipment, Horstmann offers a comprehensive and high-quality range of portable devices:

- ▶ for temporary earthing or
- ▶ earthing and short-circuiting of disconnected or isolated switchgear

This will prevent the occurrence of dangerous voltages or electric arcs if a system is re-closed accidentally or from coupling currents from adjacent systems.

The flexible Horstmann product range has a solution for almost every requirement.

Customised design in accordance with:

- ▶ Length of the cable
- ▶ Type of neutral earthing (whether or not solidly earthed)
- ▶ Rated short-circuit time
- ▶ Rated short-circuit current
- ▶ Rated short-circuit peak factor
- ▶ Required phase and earth connecting points

Earthing and short-circuiting devices

Three-phase device with ball tongs



Line cables with ball tong

PRODUCT FEATURES

- ▶ Designed according to IEC 61230 (VDE 0683-100)
- ▶ Cables assembled from highly flexible copper conductors (with transparent insulation)
- ▶ Moulded transparent connection piece allows permanent visual inspection
- ▶ Connection elements for phase cable:
 - ▶ Up to 70 mm² cross-section: 3 ball tongs 64-0103-001
 - ▶ From 70 mm² cross-section: 3 ball tongs 64-0103-002
- ▶ Connection elements for earth cable: M12 wing nut, M16 wing nut, earth clamp or earthing terminal
- ▶ Dimensions:
 - Distance between centre line of cable lug hole and entry of the connection piece:
 - Phase cable: 600 mm / 550 mm / 600 mm
 - Earth cable: 1,500 mm



Connection to: Fixed ball point Ø [mm]	Cable cross section, phase / earth cable [mm ²]	Rated values I _r [kA]/tr=1 s	Order no. of kit			
			Wing nut M12	Wing nut M16	Earth clamp	Earthing terminal
20	50 / 50	9.9	60-0108-002	—	60-0101-001	60-0107-001
20	70 / 35	13.8	60-0108-004	—	60-0101-003	60-0107-003
20	70 / 70	13.8	60-0108-003	60-0209-013	60-0101-002	60-0107-002
25	95 / 35	18.7	60-0208-002	60-0209-004	60-0201-001	60-0207-002
25	95 / 95	18.7	60-0208-001	60-0209-001	60-0202-001	60-0207-001
25	120 / 50	23.7	60-0208-003	60-0209-010	60-0201-002	60-0207-003
25	120 / 120	23.7	—	60-0209-002	60-0202-002	—

Further earthing and short-circuiting devices with other cable lengths and fittings for line or earth cable ends are available on request.

Accessories	Page
Earthing sticks	123
Hot stick	124
Wall holders	129

Earthing and short-circuiting devices

Three-phase device with universal compact clamp or universal line clamp



Line cables with universal line clamp

PRODUCT FEATURES

- ▶ Designed according to IEC 61230 (VDE 0683-100)
- ▶ Cables assembled from highly flexible copper conductors (with transparent insulation)
- ▶ Moulded transparent connection piece allows permanent visual inspection
- ▶ Connection elements for phase cable:
 - ▶ Up to 70 mm² cross-section: 3 x universal compact clamps 64-0101-001
 - ▶ From 70 mm² cross-section: 3 x universal line clamps 64-0102-002
- ▶ Connection elements for earth cable: M12 wing nut, M16 wing nut, earth clamp or earthing terminal
- ▶ Dimensions:
 - Distance between centre line of cable lug hole and entry of the connection piece:
 - Phase cable: 600 mm / 550 mm / 600 mm
 - Earth cable: 1,500 mm



Connection to:						Order no. of kit			
Connection to: Fixed ball point Ø [mm]	T-connection bolt [mm]	Round conductor [mm]	Flat conductor [mm]	Cable cross section, phase / earth cable [mm ²]	Rated values I _r [kA]/tr=1 s	Wing nut M12	Wing nut M16	Earth clamp	Earthing terminal
20	15	4–15	0–25	50 / 50	9.9	60-0308-001	—	60-0301-001	60-0307-001
20	15	4–15	0–25	70 / 35	13.8	60-0308-003	—	60-0301-003	60-0307-003
20	15	4–15	0–25	70 / 70	13.8	60-0308-002	—	60-0301-002	60-0307-002
25	15	10–25	0–28	95 / 35	18.7	60-0508-002	—	60-0501-001	60-0507-002
25	15	10–25	0–28	95 / 95	18.7	60-0508-001	60-0509-001	60-0502-001	60-0507-001
25	15	10–25	0–28	120 / 50	23.7	60-0508-003	—	60-0501-002	60-0507-003
25	15	10–25	0–28	120 / 120	23.7	—	60-0509-002	60-0502-002	—

Further Earthing and short-circuiting devices with other cable lengths and fittings for line or earth cable ends are available on request.

Accessories	Page
Earthing sticks	123
Hot stick	124
Wall holders	129

Single-phase device without connection elements



PRODUCT FEATURES

- ▶ Designed according to IEC 61230 (VDE 0683-100)
- ▶ Cables assembled from highly flexible copper conductors (with transparent insulation)
- ▶ Cable lug on each cable end

Each cable lug is provided with a 13 mm diameter hole. Any type of line or phase clamp can be used for the earthing cables.

Single-phase earthing and short-circuiting cable

Cross section of copper conductor [mm ²]	Rated values I _r [kA]/tr=1 s	Cable length [mm]	Order no.
25	4.9	800	61-0101-015
25	4.9	2,000	61-0101-003
25	4.9	2,500	61-0101-016
35	6.9	2,000	61-0102-003
35	6.9	3,000	61-0102-009
50	9.9	1,200	61-0103-001
50	9.9	1,500	61-0103-002
50	9.9	2,000	61-0103-003
70	13.8	800	61-0104-018
70	13.8	1,200	61-0104-001
70	13.8	1,500	61-0104-002
70	13.8	2,000	61-0104-003
95	18.7	1,200	61-0105-001
95	18.7	1,500	61-0105-002
95	18.7	3,000	61-0105-009
95	18.7	4,000	61-0105-008
95	18.7	5,000	61-0105-010
120	23.7	1,000	61-0106-012
120	23.7	1,200	61-0106-001
120	23.7	1,500	61-0106-002
120	23.7	2,000	61-0106-003
120	23.7	3,000	61-0106-006
150	29.6	1,200	61-0107-001
150	29.6	1,500	61-0107-002
150	29.6	2,000	61-0107-003
150	29.6	2,500	61-0107-009
150	29.6	3,000	61-0107-006

Further cable lengths available on request.

Short-circuiting bars

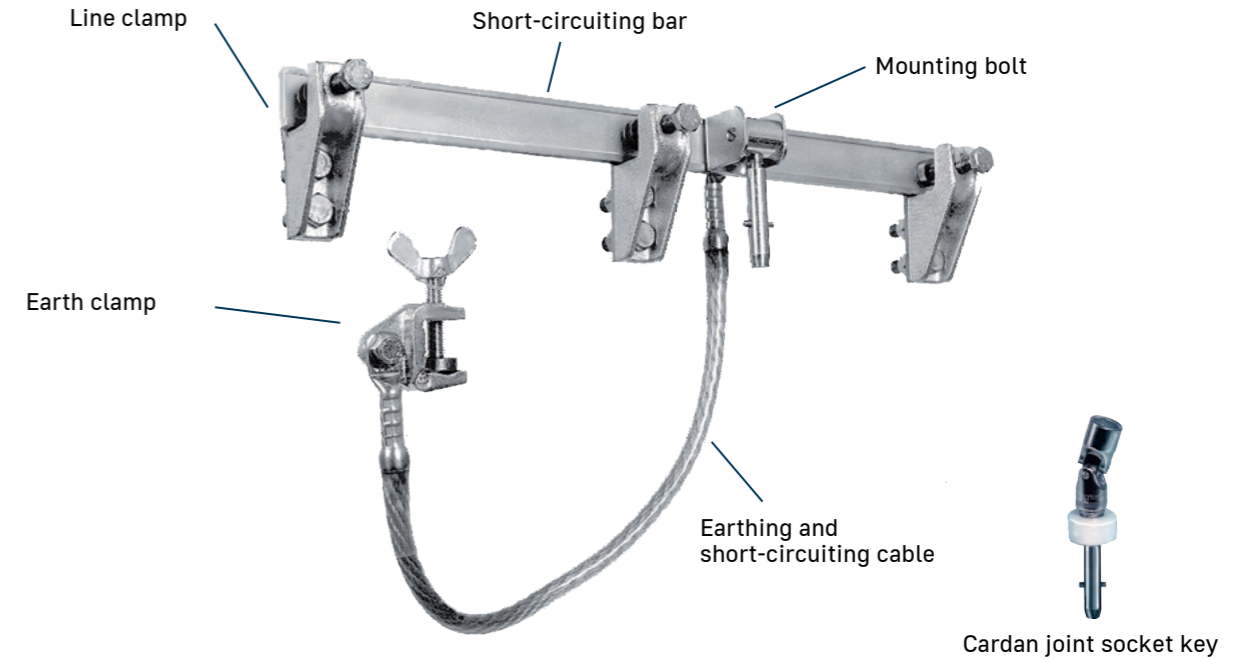

Short-circuiting bar with accessories

Equipment set	Rail length [mm]	Rated values I _r [kA]/tr=1 s ¹⁾	Phase distance of line clamps [mm]	Order no.	Page
1 short-circuiting bar, with mounting bolt	560	45.9	210	62-0101-050	
40 x 10	640	45.9	250	62-0101-051	
60 x 8	560	55.9	210	62-0101-054	
60 x 8	1,000	55.9	450	62-0101-057	
3 clamping pieces, for short-circuiting bar	Bolts	Material			
40 x 10	M12, AF19	GTW		62-0103-001	
60 x 8	M12, AF19	GK-ALSI 10 MG		62-0103-003	
1 earthing and short-circuiting cable					116
1 earth clamps					121

¹⁾ The type test of the short-circuiting bars is carried out with a rated time tr = 1 s.

Accessories	Order no.	Page
Cardan joint socket key	67-0301-001	
Earthing sticks		123

Line connection points

Fixed ball points are suitable for phase connection points and busbars

Fixed ball point with female thread

Material of straight ball pin: E-Cu, tinned

Material of angle ball pin: CuCr, tinned



Ø [mm]	Thread	Rated values I _r [kA]/tr=1 s	Order no.
20	M10	18.7	63-0101-002
20	M12	18.7	63-0101-001
25	M12	23.7	63-0101-003
25	M16	29.6	63-0101-004



Ø [mm]	Thread	Rated values I _r [kA]/tr=1 s	Order no.
20	M12	13.8	63-0103-001
25	M12	23.7	63-0103-002
25	M16	29.6	63-0103-003

Ball point with steel grub screw

Material of straight ball pin: E-Cu, tinned

Material of angle ball pin: CuCr, tinned



Ø [mm]	Thread	Rated values I _r [kA]/tr=1 s	Order no.
20	M10 x 30	18.7	63-0102-002
20	M12 x 30	18.7	63-0102-001
25	M12 x 30	23.7	63-0102-003
25	M16 x 45	29.6	63-0102-004



Ø [mm]	Thread	Rated values I _r [kA]/tr=1 s	Order no.
20	M12 x 30	13.8	63-0104-001
25	M12 x 30	23.7	63-0104-002
25	M16 x 45	29.6	63-0104-003

T-connection bolts

Material: E-Cu, tinned



Ø [mm]	Thread	Rated values I _r [kA]/tr=1 s	Order no.
15	M12	13.8	63-0106-001
15	M12 x 30	13.8	63-0106-002

Line clamps

Line clamps with bayonet fitting

Material of universal compact clamp: CuCr, tinned

Material of universal line clamp: brass, tinned

Material of ball tongs: brass, zinc-plated



Ball pin Ø [mm]	Connection to				Rated values I _r [kA]/tr=1 s	Order no.			Ball tong
	T-connection bolt [mm]	Round conductor [mm]	Flat conductor [mm]			Universal compact clamp	Universal line clamp	Universal line clamp	
20	—	—	—	—	18.7	—	—	—	64-0103-001
25	—	—	—	—	29.7	—	—	—	64-0103-002
20	15	4–15	≤25	13.8	64-0101-001	—	—	—	—
20	—	10–20	≤22	13.8	—	64-0102-001	—	—	—
25	15	10–25	≤28	23.7 ¹⁾	—	—	—	64-0102-002	—
20/25	15	10–25	≤28	18.7/23.7 ¹⁾	—	—	—	64-0102-003	—
25/30	15	10–30	≤28	23.7	—	—	—	64-0102-004	—

¹⁾The rated value for the T-connection bolt is always 13.8 kA.

Line clamps with hexagon spindle

Material: brass, zinc-plated



Ø [mm]	Rated values I _r [kA]/tr=1 s	Order no.
20	18.7	64-0103-005
25	23.7	64-0103-006

Earth connection bolts with ring groove for earthing terminal

Material: brass, tinned



With steel pin

Fixing in switchgears [mm]	Rated values Ir [kA]/tr=1 s	Order no.
M12x25	18.7	63-0201-007
M12x40	18.7	63-0201-006



With female thread

Fixing in switchgears [mm]	Rated values Ir [kA]/tr=1 s	Order no.
M12	18.7	63-0201-003

Earthing weld nut for cable lug with captive wing nut or with 13 mm diameter hole

Material: steel, zinc-plated



Fixing in switchgears [mm]	Rated values Ir [kA]/tr=1 s	Order no.
M12 x 30	18.7	63-0204-001

Earthing screw for cable lug with captive wing nut

Material: brass, zinc-plated



Fixing point for earthing device [mm ²]	Spanner size	Rated values Ir [kA]/tr=1 s	Order no.
M12x60	32	13.8	63-0205-001
M16x70	32	18.7	63-0205-002

Earthing screw adapter for cable lug with captive wing nut

Material: brass, zinc-plated



Thread [mm ²]	Spanner size	Rated values Ir [kA]/tr=1 s	Order no.
M12 to M16	32	18.7	63-0205-003

Earthing nut for cable lug with captive wing bolt

Material: brass, zinc-plated



Female thread [mm ²]	Bolt thread [mm ²]	Spanner size	Rated values Ir [kA]/tr=1 s	Order no.
M12	M12x25	32	9.9	63-0206-001
M12	M16x30	32	9.9	63-0206-003
M16	M12x25	32	9.9	63-0206-002

Earth clamp for flat conductors

Material: CuNi, zinc-plated



With T-handle

Clamping range [mm]	Rated values Ir [kA]/tr=1 s	Order no.
23	18.7	64-0201-001
38	29.6	64-0201-002



With wing bolt

Clamping range [mm]	Rated values Ir [kA]/tr=1 s	Order no.
23	18.7	64-0201-003
38	29.6	64-0201-004



With bayonet connector

Clamping range [mm]	Rated values Ir [kA]/tr=1 s	Order no.
23	18.7	64-0201-005
38	29.6	64-0201-006

Universal earth clamp with handle

Material: brass, tinned



Connection to:				Rated values Ir [kA]/tr=1 s	Order no.
Fixed ball point Ø [mm]	Round conductor mm	T-connection bolt [mm]	Flat conductor [mm]		
25	10–25	15	≤28	23.7 ¹⁾	64-0102-007
20/25	10–25	15	≤28	18.7 / 23.7 ¹⁾	64-0102-016
25/30	10–25	15	≤28	23.7 ¹⁾	64-0102-012

1) The rated value for the T-connection bolt is always 13.8 kA.

Earthing terminal

Material: brass, zinc-plated / E-Cu



Cable cross section [mm ²]	Rated values Ir [kA]/tr=1 s	Order no.
50	9.9	64-0202-003
70	13.8	64-0202-004
95	18.7	64-0202-005

Cable lug with 13 mm Ø hole

Material: E-Cu, tinned



Cable cross section [mm ²]	Rated values I _r [kA]/tr=1 s	Order no.
50	9.9	64-0205-003
70	13.8	64-0205-004
95	18.7	64-0205-005

Cable lug with captive wing nut

Material: E-Cu, tinned



Cable cross section [mm ²]	Thread	Rated values I _r [kA]/tr=1 s	Order no.
120	M12	23.7	64-0213-001
150	M16	29.6	64-0213-002

Cable lug with captive wing bolt

Material: E-Cu, tinned



Cable cross section [mm ²]	Thread	Rated values I _r [kA]/tr=1 s	Order no.
120	M12	23.7	64-0214-001
150	M16	29.6	64-0214-002

For installation and removal of earthing and short-circuiting devices in high-voltage installations

PRODUCT FEATURES

- ▶ Designed according to VDE 0683-100 (IEC 61230)
- ▶ Material: fibreglass reinforced epoxy resin tube
- ▶ Types: bayonet or hexagonal fitting
- ▶ Application for indoor installations

The insulating element of the earthing stick must be of adequate dimension to avoid inadmissible high leakage currents. The minimum length of the insulating element is 500 mm.



Indoor application earthing stick

Dimensions [mm]		Order no.	
a ¹⁾	b	Bayonet fitting	Hexagon fitting
1,117	717	66-0101-001	66-0201-001
1,517	917	66-0101-002	66-0201-002
2,017	1,217	66-0101-003	66-0201-003

¹⁾ Dimensions apply to earthing sticks with bayonet fitting. Earthing sticks with hexagonal fitting are 12 mm longer.

Hot sticks

Manual operation of live parts

PRODUCT FEATURES

- ▶ Designed according to DIN VDE 0681-1
- ▶ Material: fibreglass reinforced epoxy resin tube
- ▶ Types: bayonet or hexagonal fitting
- ▶ Application for indoor 🏠 or outdoor 🌳 installation

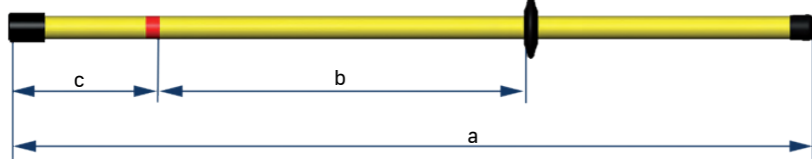

Indoor application hot stick

Nominal voltage range [kV]	Dimensions [mm]			Order no.	
	a ¹⁾	b	c ¹⁾	Bayonet fitting	Hexagon fitting
1–24	1,117	500	217	65-0101-001	65-0201-001
1–36	1,217	525	242	65-0101-002	65-0201-002
1–52	1,517	720	197	65-0101-003	65-0201-003
1–72.5	2,017	905	312	65-0101-004	65-0201-004

1) Dimensions apply to hot stick with bayonet head. Hot stick with hexagon fitting are 12 mm longer.

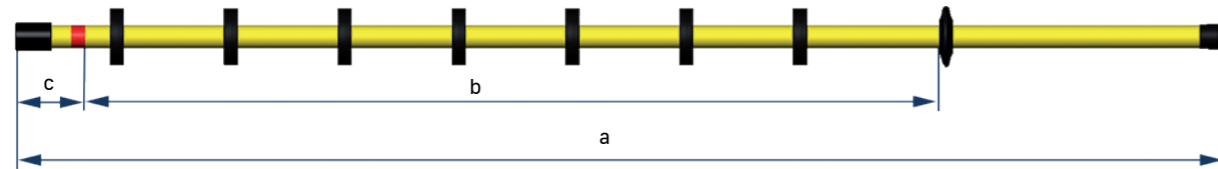

Outdoor application hot stick

Nominal voltage range [kV]	Dimensions [mm]			Order no. Bayonet fitting
	a	b	c	
1–36	1,707	1,200	107	65-0102-001
1–72.5	2,317	1,600	117	65-0102-002

With hook for applications in dry weather conditions 🏠

The hook serves to mount and dismount elbow connectors and for overhead faulted circuit indicator installations and removals

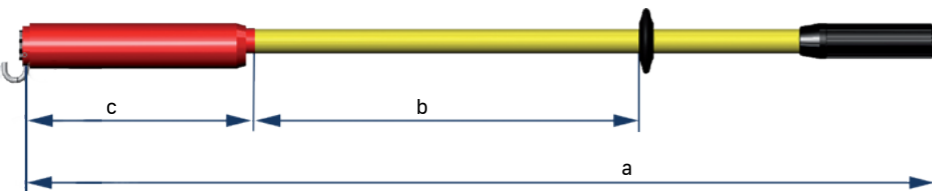

Hot stick with hook

Nominal voltage range [kV]	Dimensions [mm]			Order no.
	a	b	c	
1–24	1,200	500	310	65-0301-001
1–36	2,000	900	310	65-0301-002
1–36	3,000	900	310	65-0301-003
1–52	2,000	900	310	65-0301-004

Operating rods

Used to switch on and off switches with ring eyes

PRODUCT FEATURES

- ▶ Designed according to VDE 0681-2 (DIN 57681-2)
- ▶ Material: fibreglass reinforced epoxy resin tube
- ▶ One-part and two-part pluggable design
- ▶ Application for indoor 🏠 or outdoor 🌳 installation

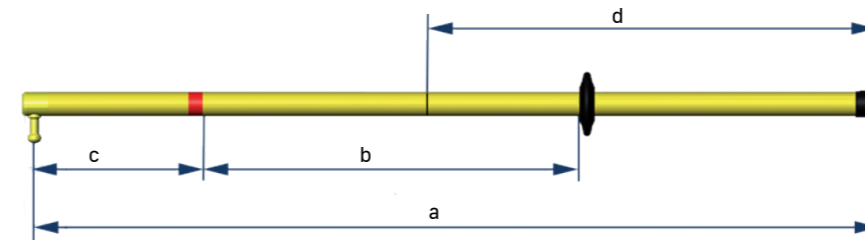

Indoor application operating rod

Nominal voltage range [kV]	Dimensions [mm]				Order no.	
	a	b	c	d ¹⁾	One-part	Two-part
1–24	1,120	505	215	600	65-0401-001	65-0403-001
1–36	1,220	525	245	—	65-0401-002	—
1–52	1,520	720	200	800	65-0401-003	65-0403-003
1–72.5	2,020	900	320	1,050	65-0401-004	65-0403-004

1) Dimensions only for two-part operating rods.

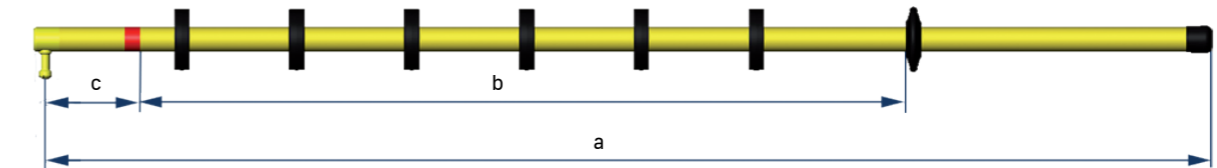

Outdoor application operating rod

Nominal voltage range [kV]	Dimensions [mm]			Order no.
	a	b	c	
1–24	1,520	1,000	120	65-0402-001
1–36	1,720	1,200	120	65-0402-002
1–52	2,180	1,400	180	65-0402-003
1–72.5	2,320	1,600	120	65-0402-004

Switch hook with bayonet fitting

Suitable for all hot sticks (bayonet fitting according to DIN 48087)



Order no.
67-0301-003

Fuse tongs

For gripping and replacing high-voltage fuses

PRODUCT FEATURES

- ▶ According to DIN VDE 0681-3

The fuse tongs are guided over the fuses from the front, thus requiring little spaces to the side. They are ideally suited for use in narrow installations. The clamps are fixed and released by turning the handle.

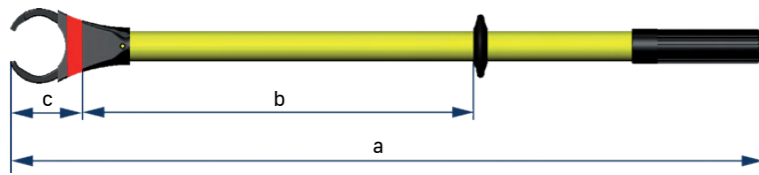

Fuse tong type K

Nominal voltage range [kV]	Dimensions [mm]			Clamping range [mm]	Order no.
	a	b	c ¹⁾		
1–36	1,010	530	85	50–90	65-0502-002

1) In closed position.

Tools for fuses

Material: Special brass



Total length [mm]	Order no.
305	65-0504-004
385	65-0504-001

Substation accessories

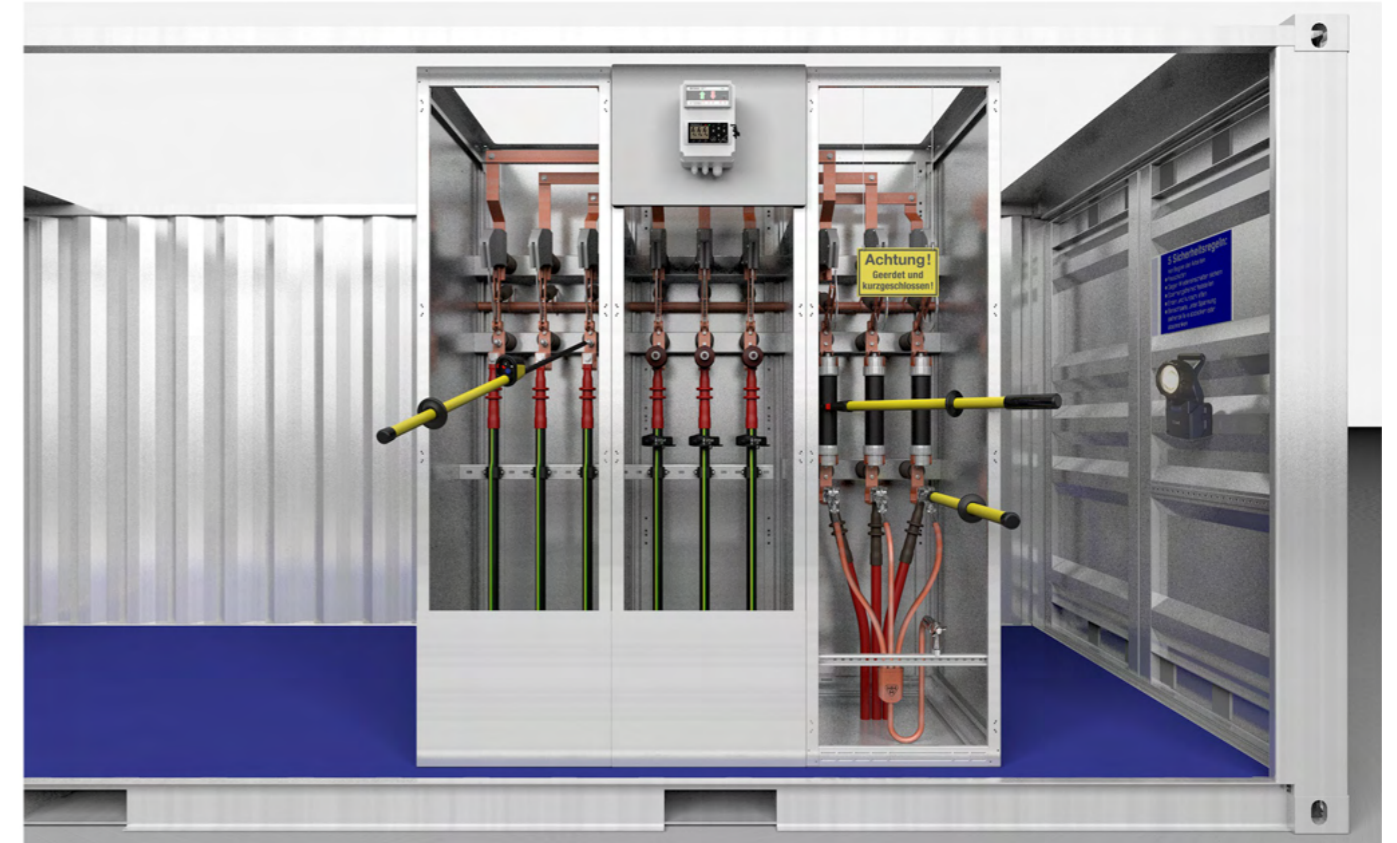

Station accessories are not only part of safety-relevant equipment, they play a crucial role in the safe, efficient, and reliable operation of local network and medium-voltage installations. Regardless of whether you are cleaning the system from dirt or moisture as part of maintenance or performing a functional test: To be able to work safely and without danger, you need the appropriate equipment.

Our range includes, among others, the following accessories for your medium-voltage system:

- ▶ Fuse testing devices
- ▶ Wall holders
- ▶ Warning signs
- ▶ Safety helmets
- ▶ Fire extinguishers and gloves

You can find additional accessories such as grounding rods, operating rods, switching rods, fuse tongs, or fixed points and connection terminals in the chapter "Earthing devices" on page 112ff.

PRODUCT FEATURES

The mechanical HPS fuse testing device is designed to control the trip function of load break switches. After winding up the timer the striker pin is reset and the testing device is inserted into the fuse cartridge of the switch to be checked. After about 150 s ±20 % the test fuse is operated whereupon the striker fires out. The size of the fuse corresponds to that of HH fuses with 6 kV nominal voltage. Extension pieces are available for the adaptation to other voltage levels.

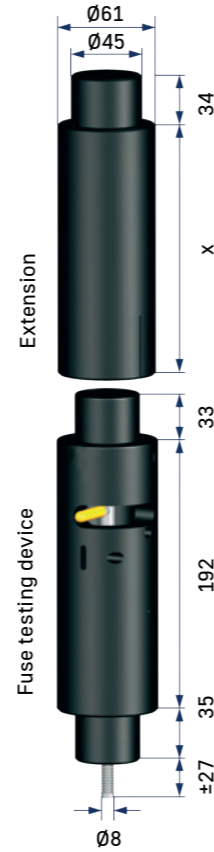

Fuse testing device and extension

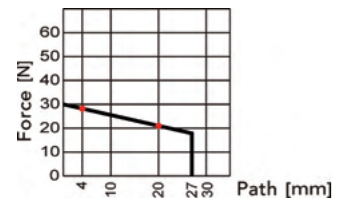

Rated release force 30 N	
Free stroke	
4 mm [N]	28.2
20 mm [N]	20.8
Energy [J]	0.39
Order no.	49-6015-007 (white)

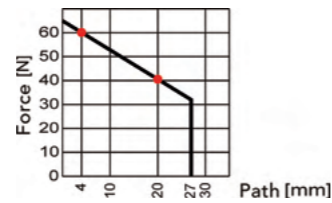

Rated release force 65 N	
Free stroke	
4 mm [N]	60.1
20 mm [N]	40.6
Energy [J]	0.81
Order no.	49-6015-005 (yellow)

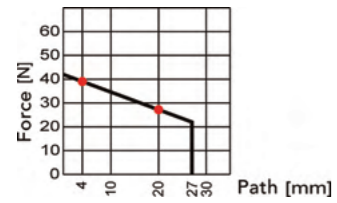

Rated release force 42 N	
Free stroke	
4 mm [N]	39.0
20 mm [N]	27.2
Energy [J]	0.53
Order no.	49-6015-001 (black)

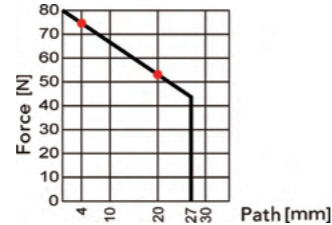

Rated release force 80 N	
Free stroke	
4 mm [N]	74.7
20 mm [N]	53.3
Energy [J]	1.02
Order no.	49-6015-008 (silver)

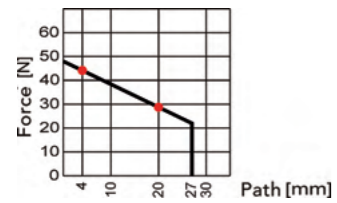

NRated release force 48 N	
Free stroke	
4 mm [N]	44.1
20 mm [N]	28.7
Energy [J]	0.58
Order no.	49-6015-006 (blanc)

Accessories	Vn [kV]	Order no.
Extension		
100 mm	12.0	49-6015-003
175 mm	17.5	49-6015-004
250 mm	24.0	49-6015-002
Bag		52-0102-003

For safety material



Order no.	67-0101-001	67-0101-002	67-0101-006	67-0101-007	67-0101-014	67-0101-015
Earthing and short-circuiting devices	■	—	—	—	—	—
Earthing sticks	■	■	■	—	—	—
Hot sticks	■	■	■	—	—	—
Operating rods	■	■	■	—	—	—
Fuse tongs	—	—	—	■	■	—
HH fuses	—	—	—	—	■	■

For voltage detectors



Order no.	52-0105-001	52-0105-002
FL-I	■	■
TP-I	■	■
Comet BK-I / BK-A	■	■
Comet BL-I / BL-A	■	■
Comet BS-I / BS-A	■	■

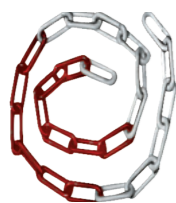

Plastic chain

Red / white with nylon links

Order no.
67-0202-001



Safety helmet

Without face shield
Order no. 67-0202-002

With face shield
Order no. 67-0202-003



High-grade protective helmet

Without face shield
Order no. 67-0202-012

With face shield
Order no. 67-0202-013

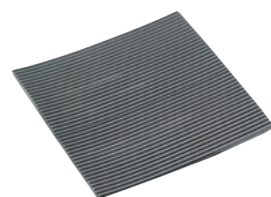

Rubber insulating matting

Up to 50 kV, max. 1 m wide,
4 mm thick, 10 m long
(delivered as a roll)

Order no.
67-0202-004



Insulating protective barrier

- ▶ According to VDE 0682-552
- ▶ PVC hard DIN 16927
- ▶ Colour: Red
- ▶ Plate thickness: <30 kV,
6 mm
- ▶ Special insulation
resistance: 1015 Ω cm
- ▶ Surface resistivity: 1011 Ω

Order no.: On request



Protective gloves

For electricians, 1,000 V
according to VDE 0680-1 with
certification stamp, length: 350
mm, thickness: 0.7 mm

Order no.
67-0202-005



Handheld fire extinguisher

Filled with 5 kg of carbon di-
oxide, with snow pipe and wall
holder

Order no.
67-0202-007



LED work lamp

Incl. wall-mounting charge
station with charge status
display, flashing and emergen-
cy light function

Order no.
67-0202-010



Insulating protective barriers are intended for short-term use in electrical indoor switchgears exceeding voltage ratings from 1 kV bis 30 kV AC. These devices may be used in factory-built, type-tested switchgears only in compliance with the switchgear manufacturer's instructions.

Insulating protective barriers are designed for partial protection against direct touching. These components do not protect against reclosure and must not touch live parts when installed.

Dimension drawings

The products marked with * are available in the ePLAN data Portal with the circuit diagram and terminal assignment.

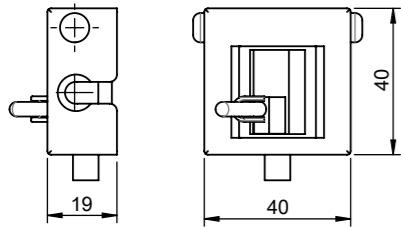

M1: Rotor indicator

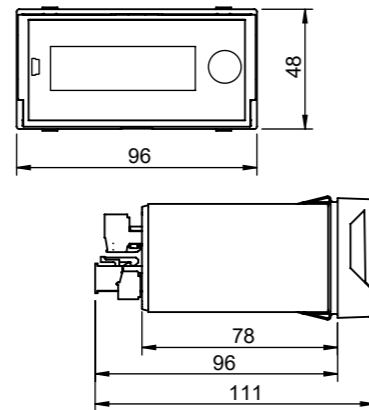

M4: ComPass A 2.0*, ComPass B 2.0*, ComPass Bs 2.0*, ComPass D

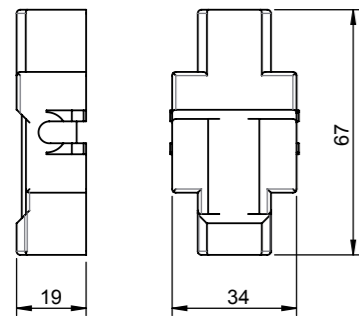

M2: Fluid indicator

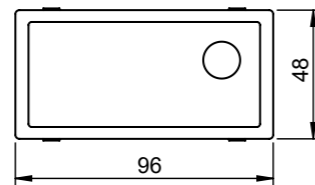

M5: Alpha M, Trip Flag

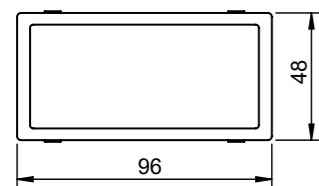

M3: Alpha E, ComPass A, ComPass B*, Opto series, Sigma series*

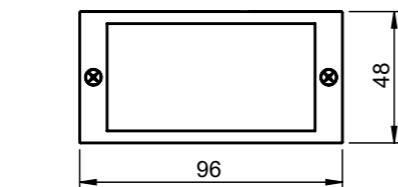
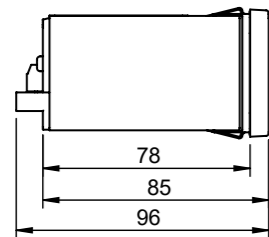

M6: Earth series (surface mount housing)

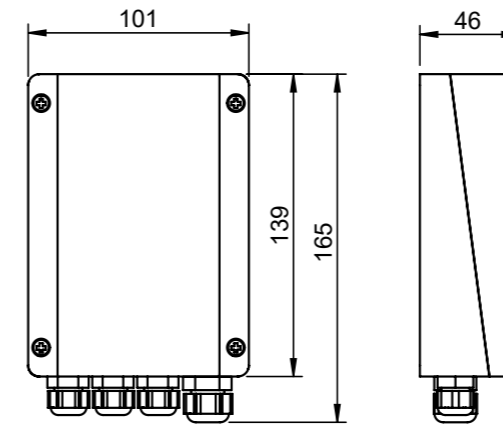
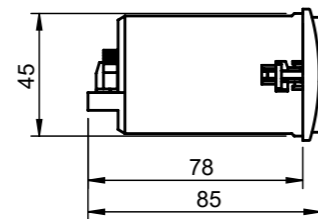

M7: Earth series, Opto series (Surface mount housing)

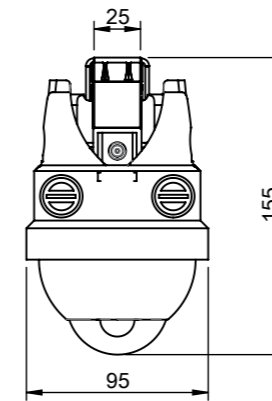

M8: Navigator series

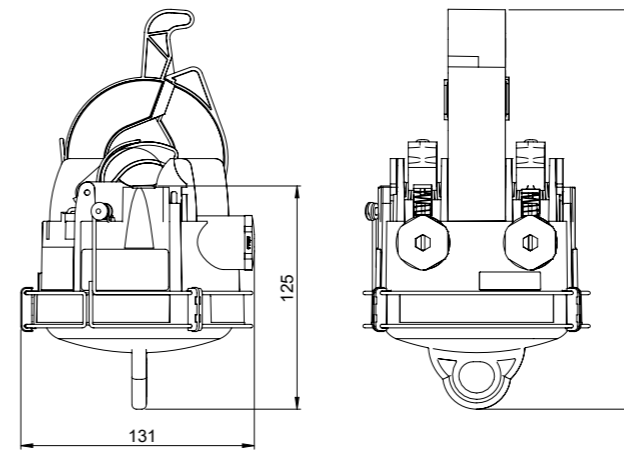

M9: Smart Navigator 2.0

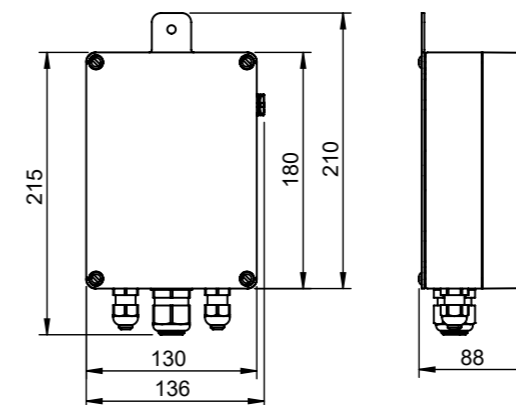

M10: Reporter 3.0

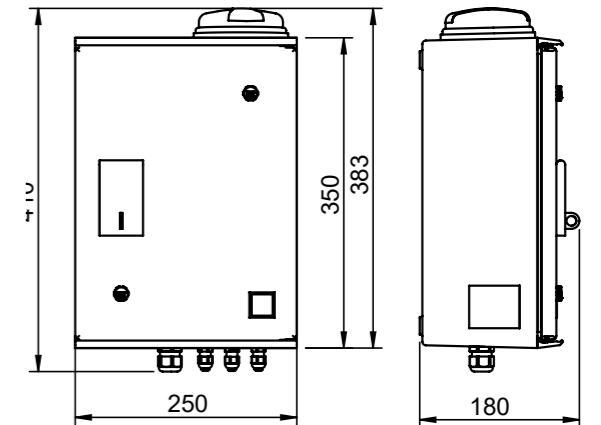

M11: Reporter 4.0

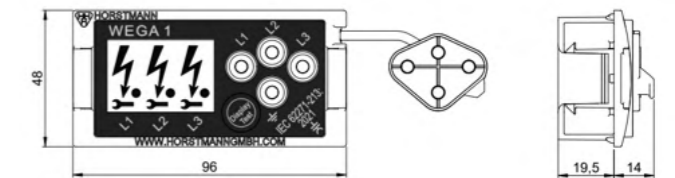

M12: Wega 1 / Wega 1 V

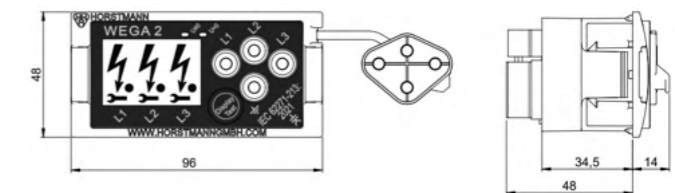

M13: Wega 2 / Wega 2 V

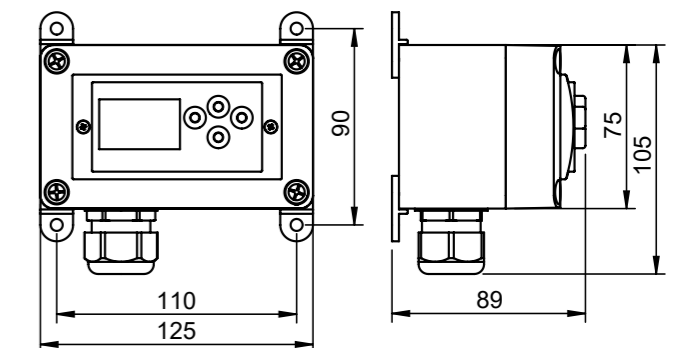

M14: Wega T1

Dimension drawings

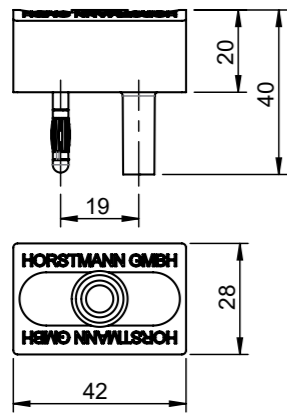

M15: HR-ST

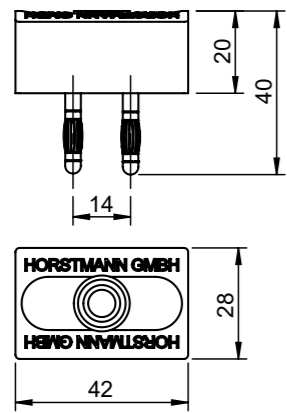

M16: LRM-ST

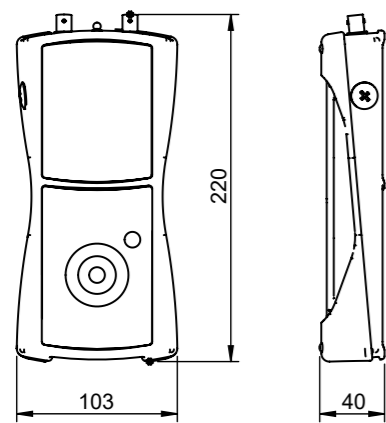

M17: Orion 3.1, Orion M1

Order | inquiry

Order no.:		Inquiry no.:	
------------	--	--------------	--

Order no.	Article description	Quantity	Delivery date

	Company:	
	Contact person:	
	Department:	
	Street:	
	Postcode / Place:	
Stamp / Date / Signature	Phone	

An order is made exclusively by the terms and conditions of Dipl.-Ing. H. Horstmann GmbH.

Order | inquiry

Earthing and short-circuiting devices

Order no.		Inquiry no.	
-----------	--	-------------	--

Short-circuiting cable (a / b / c)	
Cable cross section (mm²):	
Length a:	
Length b:	
Length c:	
Mounting:	
Earthing cable (d)	
Cable cross section (mm²):	
Length d:	
Mounting (see page 121 / 122):	
Quantity:	
Date of delivery:	

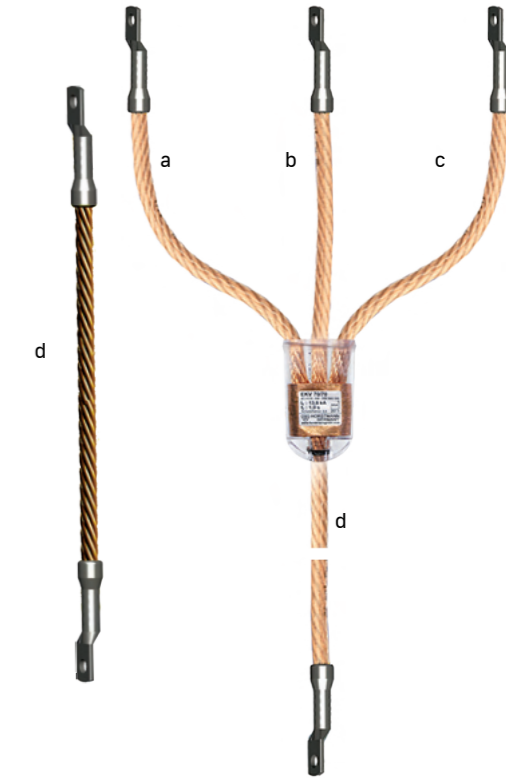

Lengths of earthing and short-circuit cables have to fit to the switchgear and the distances between the connection points (min 1.2 times of the distance). If the cables are too long (>1.5 times of the distance) they must be fixed with an insulating cable to prevent damages and injuries in case of a short-circuit.

	Company:	
	Contact person:	
	Department:	
	Street:	
	Postcode / Place:	
Stamp / Date / Signature	Phone	

An order is made exclusively by the terms and conditions of Dipl.-Ing. H. Horstmann GmbH.

Index

A

- Accessories
 - Directional fault indicators 58-59
 - Integrated voltage detecting systems 58
 - Overhead faulted circuit indicators 70
 - Short-circuit and earth fault indicators 58
 - Short-circuit indicators 58
 - Voltage detectors and phase comparators 137
- Alpha E 26
- Alpha M 26

B

- BO-A 2.0 104–105
- BO-A AC/DC 106–107

C

- Capacitive voltage signal 84
- Comet BK-A 102
- Comet BK-I 102
- Comet BL-A 101
- Comet BL-I 101
- Comet BS-A 103
- Comet BS-I 103
- Company profile 8
- Compare 2.0 108
- ComPass A 32
- ComPass A 2.0 34
- ComPass B 42
- ComPass B 2.0 44
- ComPass BS 2.0 44
- ComPass D 46
- CSOR 51

D

- Dimension drawings 132
- Directional fault indicators
 - Product matrix 14-15
 - Project planning 37

E

- Earth 4.0 27
- Earth clamps
 - Earth clamp 121
 - Earthing terminal 121
 - Cable lug 122
 - Universal earth clamp with handle 121
- Earth fault indicator 23–25
- Earth connection points 120
 - Earth connection bolts 120
 - Earthing nut 120
 - Earthing screw 120
 - Earthing screw adapter 120
 - Earthing weld nut 120
- Earthing sticks 123

- Earthing and short-circuiting devices 112–113
 - Single-phase device without connection elements 116
 - Three-phase device with ball tongs 114
 - Three-phase device with universal line clamp 115
 - External signal lamp 58
- Earthing sticks 123
- Earth Zero 24
- Earth Zero Flag 24

F

- FL-I 104
- Fluid indicator 17
- Function tester LRM- /HR-ST 96
- Fuse testing devices 128
- Fuse tongs 126

H

- Hot stick with hook 70 | 124
- HR interface cable 54
- HR-ST 96

I

- iHost
 - iHost Cloud 72
 - iHost Pro 74–75
 - iHost Solo 74–75
- Interface cable 54

L

- Line clamps
 - Line clamps with bayonet fitting 119
 - Line clamps with hexagon spindle 119
- Line connection points
 - Ball point with steel grub screw 118
 - Fixed ball point with female thread 118
- T-connection bolts 118
- LRM-ST 96

M

- Maintenance test 111

N

- Navigator LM 64
- Navigator LM HV 64

O

- Operating rods 125
- Opto F+E 3.0 26
- Opto F 3.0 18
- Orion 3.1 94
- Orion M1 94
- Overhead faulted circuit indicators
 - Accessories 70
 - Product matrix 63

P

- PG II 109
- Line clamps 119
- Phase comparators 108
- Phase current transformers 48

R

- Remote monitoring 71
- Reporter 3.0 76
- Reporter 4.0 78
- Rotor indicator 16

S

- Short-circuit and earth fault indicators
 - Accessories 58
 - General information 9
 - Phase current transformers 48
 - Product matrix 12
 - Selection scheme 2436
 - Single-phase current sensors 50
- Short-circuit indicators 18-22
- Sigma 2.0 20
- Sigma D 38
- Sigma D+ 38
- Sigma D++ 38
- Sigma Dm 40
- Sigma F+E 2.0 28
- Sigma F+E 3 2.0 28
- Sigma L 30
- Sigma F+E L 30
- Sigma F+E 3 L 30
- Smart Navigator 2.0 68
- Smart Navigator 2.0 HV 64
- Summation current sensors 51

T

- Trip Flag 68

V

- Voltage detecting systems
 - General information 82
 - Integrated voltage detecting systems 84-90
 - Product matrix 83
 - Voltage detectors 94
 - Accessories 95
- Voltage sensors 54
- Capacitive voltage coupling 54
- Resistive voltage sensors 55
- Voltage signal 54

W

- Wall holders 129
- Wega 1 84
- Wega 1 V 86
- Wega 2 88
- Wega 2 V 90
- Wega 1 LV 91
- Wega T1 92

General terms of delivery

Product Range

Our catalogues and supplementary documents feature a selection of our product range. Additionally, a wide variety of customer-specific solutions and configurations are available. Please feel free to contact us if you require customised products or cannot find what you are looking for.

Catalogues, Leaflets, and Instructions for Use

We offer the latest editions of catalogues and leaflets for our customers and interested parties, accessible via our website: <http://www.horstmannmbh.com>.

For our customers, there is also the option to download the most recent instructions for use of all current devices as PDF files through a password-protected portal.

If you require further documents or have any questions, please do not hesitate to reach out to us. We are here to assist you.