

## **PowerFlow RAPID**

**For single cable**



## **MultiFlow RAPID**

**For both single cable and relining**



# Operating manual

**Responsible manufacturer: Fremco A/S**

**Machine: PowerFlow RAPID & MultiFlow RAPID**

This is the original operating manual for PowerFlow RAPID and MultiFlow RAPID from Fremco.



## TABLE OF CONTENTS

<b>1.</b>	<b>INTRODUCTION</b> .....	<b>6</b>
<b>2.</b>	<b>GENERAL</b> .....	<b>7</b>
2.1.	MANUFACTURER.....	7
2.2.	THE MACHINE'S DESIGNATION.....	7
2.3.	MACHINE PLATE.....	7
2.4.	MACHINE MARKINGS.....	8
<b>3.</b>	<b>TECHNICAL SPECIFICATIONS</b> .....	<b>9</b>
3.1.	POWERFLOW RAPID.....	9
3.2.	MULTIFLOW RAPID.....	10
3.3.	HYDRAULIC CONTROL UNIT.....	11
<b>4.</b>	<b>SAFETY AND RESIDUAL RISKS</b> .....	<b>13</b>
4.1.	BUILT-IN SAFETY MEASURES .....	13
4.1.1.	SAFETY FUNCTIONS.....	13
4.2.	WARNING - FORESEEABLE MISUSE .....	14
4.3.	SAFETY MEASURES, TO BE TAKEN BY THE USER .....	14
4.3.1.	CLOTHING AND PERSONAL PROTECTIVE EQUIPMENT (PPE) .....	14
4.3.2.	HANDLING OF DANGEROUS SUBSTANCES AND MATERIALS .....	15
4.3.3.	RESIDUAL RISKS .....	15
4.3.4.	WORK PROCEDURES .....	16
4.3.5.	IN CASE OF EMERGENCY .....	16
4.3.6.	VIOLATION OF SAFETY REGULATIONS.....	16
<b>5.</b>	<b>OVERVIEW AND APPLICATION</b> .....	<b>17</b>
5.1.	GENERAL DESCRIPTION.....	17
5.2.	THE MACHINE'S PURPOSE AND INTENDED USE .....	17
5.3.	OPERATING POSITIONS, LOCATION AND ARRANGEMENT.....	18
5.4.	USER INTERFACE .....	19
5.5.	MACHINE ASSEMBLY AND ADJUSTMENT.....	21
<b>6.</b>	<b>TRAINING</b> .....	<b>24</b>
6.1.	OPERATORS .....	24
6.2.	MAINTENANCE PERSONNEL .....	24

<b>7.</b>	<b>OPERATION .....</b>	<b>25</b>
7.1.	TRANSPORTING THE MACHINE .....	25
7.2.	START/STOP .....	25
7.3.	ENERGY SUPPLY CONNECTION/DISCONNECTION.....	25
7.4.	FEEDING/REMOVING PRODUCTS.....	27
7.5.	AIR/WATER SUPPLY.....	27
<b>8.</b>	<b>MAINTENANCE, TROUBLESHOOTING AND REPAIR.....</b>	<b>28</b>
8.1.	QUICK GUIDE TO MAINTENANCE, TROUBLESHOOTING AND REPAIR .....	28
8.2.	PREPARATION FOR MAINTENANCE AND REPAIR .....	28
8.2.1.	CLEANING .....	28
8.2.2.	CORRECTIVE MAINTENANCE .....	28
8.2.3.	REPAIR.....	29
8.3.	SERVICE AND REPAIR ADDRESS .....	29
8.4.	DISCONNECTION AND DEPRESSURIZATION OF ENERGY SOURCES.....	29
8.5.	MAINTENANCE SCHEDULE .....	30
8.5.1.	VISUAL INSPECTION .....	32
8.5.2.	CHAIN SUPPORT RAIL .....	32
8.5.3.	LUBRICATION OF THE CHAINS AND CHAIN SUPPORT RAIL .....	33
8.5.4.	CHAIN ADJUSTMENT .....	33
8.5.5.	CHAINS AND SPROCKET WEAR.....	34
8.5.6.	SPINDLE LUBRICATION .....	35
8.6.	WEAR AND TEAR PARTS.....	35
<b>9.</b>	<b>BLOWING TECHNIQUE .....</b>	<b>37</b>
9.1.	BEFORE FIBER BLOWING .....	37
9.2.	PREPARING THE DUCTS FOR FIBER BLOWING .....	37
9.3.	INITIATING FIBER BLOWING .....	38
<b>10.</b>	<b>CESSATION OF USE .....</b>	<b>39</b>
10.1.	DISMANTLING .....	39
10.2.	SCRAPPING.....	39
<b>11.</b>	<b>EC DECLARATION OF CONFORMITY .....</b>	<b>40</b>
<b>12.</b>	<b>UKCA DECLARATION OF CONFORMITY.....</b>	<b>41</b>

<b>13.</b>	<b>APPENDIXES.....</b>	<b>42</b>
13.1.	HYDRAULICS SCHEMATICS .....	42
13.2.	PNEUMATICS SCHEMATICS .....	43
13.3.	DRAWINGS OF MECHANICAL CONSTRUCTION .....	44



# BEST WARRANTY IN THE BUSINESS

We offer a unique 36 months warranty on all our fiber blowing machines resulting, guaranteeing you the best value for your money.



Our 12 months warranty is automatically included when you purchase your Fremco fiber blowing machine, you automatically get our 12 months warranty. You can then claim your additional 24 months warranty at any point during the following three months in order to obtain the best cost-beneficial warranty in the business.

To maintain your 36 months warranty, you must meet the given annual service and maintenance requirements for each machine as described in the operating manual.

Learn more at [www.fremco.dk/warranty](http://www.fremco.dk/warranty) and get the best factory warranty in the business today!



# 1. INTRODUCTION

## Original instructions

These instructions are Fremco A/S' original instructions for the PowerFlow RAPID and/or MultiFlow RAPID (hereafter called the machine).

## Purpose

The purpose of these instructions is to ensure correct installation, use, handling and maintenance of the machine. Applicable from machine serial number 9328.3649 (PowerFlow RAPID) & 9328.3748 (MultiFlow RAPID).

## Accessibility

The instructions are to be kept in a location known to the staff and must be easily accessible for the operators and maintenance personnel.

## Knowledge

It is the duty of the employer (the owner of the machine) to ensure that everybody operating, servicing, maintaining, or repairing the machine reads and understands the instructions. As a minimum, they should read the part(s) relevant to their work.

In addition to this, everybody operating, servicing, maintaining, or repairing the machine is obliged to seek out information in the operating manual when needed.



## 2. GENERAL

### 2.1. MANUFACTURER

The machine is manufactured by

Company name: Fremco A/S  
 Company address: Ellehammervej 14  
 DK-9900 Frederikshavn

### 2.2. THE MACHINE'S DESIGNATION

The machine's complete designation is PowerFlow RAPID or MultiFlow RAPID.

### 2.3. MACHINE PLATE

The machine plate is situated on the front of the machine:

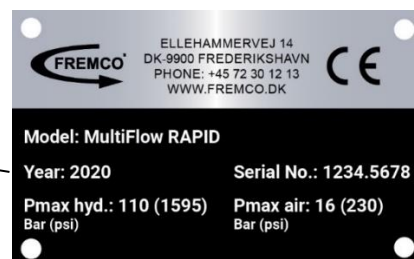

Figure 1: Location of machine plate

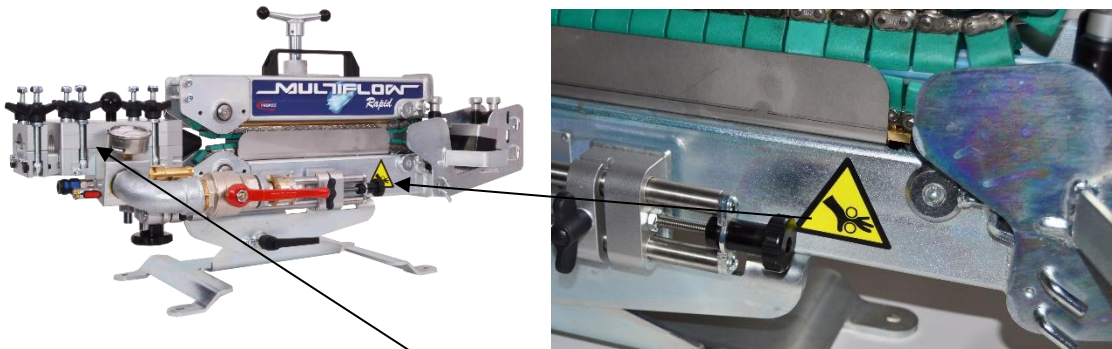

Figure 2: Location of the UKCA sticker is placed next to the machine plate

## 2.4. MACHINE MARKINGS

The machine is equipped with the following safety markings:

- Hand crush hazard symbol



- Max. air pressure on the Flex block RAPID





### 3. TECHNICAL SPECIFICATIONS

#### 3.1. POWERFLOW RAPID

Manufacturer	Fremco A/S Ellehammervej 14 9900 Frederikshavn Denmark
Item No. ....	101-40001
Cable diameter <sup>1</sup> .....	5.5-25 mm
Duct diameter <sup>2</sup> .....	10-63 mm
Blowing distance <sup>3</sup> .....	Up to 5,000 m (16404 ft)
Floating distance <sup>3</sup> .....	Up to 10,000 m (32808 ft)
Blowing speed <sup>3</sup> .....	Up to 80 m/min. (262 ft)
Pushing force .....	0-125 kg (0-275 lbs)
Max. pressure and airflow <sup>4</sup> : .....	16 bar (232 psi), 8,000-12,000 l/min. (282.5-423.7 cfm)
Max. hydraulic pressure.....	110 bar (1595 psi)
Weight .....	45 kg (99 lbs)
Length.....	950 mm (38")
Width .....	400 mm (16")
Height.....	500 mm (20")

<sup>1</sup>Two sets of chains needed (5.5-8 mm/8-16 mm/14-25 mm).

<sup>2</sup>Standard duct OD: 14 - 60 mm, Custom made duct OD: 10-13 mm & 61 -63 mm

<sup>3</sup>Depending on type and quality of fiber cable and microduct

<sup>4</sup>Air must be filtered, cooled and dried



### 3.2. MULTIFLOW RAPID

Manufacturer

Fremco A/S  
Ellehammervej 14  
9900 Frederikshavn  
Denmark

Item No. ....	101-40021 (Single cable) & 101-40002 (Relining)
Cable diameter <sup>1</sup> .....	5.5-32 mm
Duct diameter <sup>2</sup> .....	10-63 mm
Blowing distance <sup>3</sup> .....	Up to 5,000 m (16404 ft)
Floating distance <sup>3</sup> .....	Up to 10,000 m (32808 ft)
Blowing speed <sup>3</sup> .....	Up to 80 m/min. (262 ft)
Pushing force .....	0-200 kg (0-440.9 lbs)
Max. pressure and airflow <sup>4</sup> : .....	8-12 bar (116-174 psi), 8,000-12,000 l/min. (282.5-423.7 cfm)
Max. hydraulic pressure.....	110 bar (1595 psi)
Weight .....	51 kg (112 lbs)
Length.....	1050 mm (41")
Width .....	400 mm (16")
Height.....	500 mm (20")

<sup>1</sup>Two sets of chains needed (5.5-8 mm/8-16 mm/14-32 mm).

<sup>2</sup>Standard duct OD: 14 - 60 mm, Custom made duct OD: 10-13 mm & 61-63 mm

<sup>3</sup>Depending on type and quality of fiber cable and microduct

<sup>4</sup>Air must be filtered, cooled and dried



### 3.3. HYDRAULIC CONTROL UNIT

Manufacturer Fremco A/S  
Ellehammervej 14  
9900 Frederikshavn  
Denmark

Item No. .... 103-10041  
 Hydraulic connection ..... 0>125 bar, 17 l/min  
 Max pressure.....125 bar  
 Manometer .....160 bar  
 Hose to fiber blowing machine ..... 1500 mm  
 Hose to hydraulic pump..... 1500 mm  
 Length.....260 mm (10")  
 Width .....230 mm (9")  
 Height.....300 mm (12")  
 Weight ..... 12 kg (26 lbs)



## **PNEUMATICS**

Air consumption: up to 12 m<sup>3</sup>/min free air per minute at max. 16 bar

The quality of compressed air must at least comply with the requirements of ISO 8573-1:2010 “Compressed air - Part 1: Contaminants and purity classes”.

Particles: Class 5

Water: Class 7

Oil: Class 4

The compressed air temperature should not exceed 8°C above the ambient temperature.

## **HYDRAULICS**

Oil consumption: 17L oil per minute at max. 110 bar

Filtrated to below 25 µm

## **NOISE**

Airborne noise emitted by the machine:

Measured sound pressure level: 85 dB(A)

Necessary measures must be taken to reduce noise at the workplace to an acceptable level. The discharge of compressed air from the machine may cause noise level to increase. This can be reduced by using the correct gasket size.

Worn gaskets can also result in an increased noise level. In addition to noise generated by the machine, the noise produces by additional process equipment (e.g. the compressor or hydraulic pump).

## 4. SAFETY AND RESIDUAL RISKS

This information is relevant for both operators and maintenance personnel.

### 4.1. BUILT-IN SAFETY MEASURES

The machine has been fitted with fixed guards for the safety of personnel/operators.

To prevent over pressurising the pneumatic system, the machine is equipped with an over pressure relief valve.

#### 4.1.1. SAFETY FUNCTIONS

Safety Function I	
Safety function	Description
Hold-to-run system for forward and backward operation of the chain drive.	The operation of the machine is implemented as a hold-to-run system. This means that the operator must perform a continuous actuation on the joystick on the hydraulic control unit in order for the machine to produce movement.  If the actuation ceases, the joystick will return to neutral and all machine movement stops immediately.
Over pressure relief valve for the pneumatic system	The machine is equipped with an over pressure relief valve, to prevent over pressurising the pneumatic system.

These safety features must always be active and must not be overridden.

#### Shut-off valve:

The machine is equipped with a quick coupling to enable the quick release of the hydraulic and pneumatics systems.

#### Test intervals:

If the below test limits are exceeded, consider the safety features to invalid and unable to protect operators from the hazards of the machine. Safety features must be tested several times a year.

## 4.2. WARNING - FORESEEABLE MISUSE

Before using the machine, operators must ensure that:

- The guarding is intact
- The operator is able to monitor all machine movements
- The hydraulic and pneumatic hoses are undamaged
- There is no damage to any pressure carrying component
- The machine is mounted/placed in a stable and secure manner regarding its foundation and general surroundings
- The required energy supply is available
- All safety functions are active and functional

The operator must NOT under any circumstances:

- Reach into/touch the chain drive while the machine is in operation
- Exceed the maximum supply pressure of hydraulic control unit, water and air.

Machine surfaces must be kept clear of clutter and must not be used as work surfaces.

## 4.3. SAFETY MEASURES, TO BE TAKEN BY THE USER

### 4.3.1. CLOTHING AND PERSONAL PROTECTIVE EQUIPMENT (PPE)

During daily use:

The designated PPE must always be used in accordance with Fremco A/S' guidelines and safety data sheets and according to the applicable national regulations.

- PPE, in the form of protective glasses and protective shoes must be used during daily operation of the machine.



Do NOT wear any loose clothing, jewellery, scarves, etc. while operating the machine.

### During maintenance and repair:

Appropriate PPE must be used for repair and maintenance work. The area around the machine must be cleaned of spills and other items.

The manufacturer's instructions must be followed when replacing a machine component.

- PPE in the form of work gloves, protective shoes and head protection must be worn when transporting parts.
- Approved lifting equipment in the form of a crane and hoist must be used when handling heavy parts.



## 4.3.2. HANDLING OF DANGEROUS SUBSTANCES AND MATERIALS

### Chemicals and hydraulic fluids:

PPE must be used in accordance with the individual product's safety data sheets when:

- Handling/using hydraulic fluids
- Installing of liquid-filled components
- Maintaining liquid-filled components
- Handling hoses/couplings containing liquid, etc.

Disposal of products and other waste must be done in accordance with the guidelines for the materials in question.

## 4.3.3. RESIDUAL RISKS

Consider the following residual risks during maintenance and repair:

- Accumulated energy in pneumatics or hydraulics
- Contact with hydraulic oil and/or lubricants

Before service and repair or maintenance, ensure the following:

- The machine has been disconnected from its energy supply

- Accumulated energy has been relieved
- The proper PPE is being used.

#### 4.3.4. WORK PROCEDURES

Before operating the machine, the following must be ensured:

- The site of operation suitable or has been made safe for operation
- The area adjacent to the machine is kept clean and free from objects that may cause the operator to slip and fall or getting caught in the machine's cables
- The area adjacent to the machine is kept free from unnecessary personnel
- There is adequate lighting to safely operate the machine
- The protective glasses and gloves are worn when connecting and disconnecting hydraulic components
- Protective glasses and protective gloves are worn when servicing hydraulic components.
- All machine components and energy supplies have been correctly installed.
- The ducts and fibers have been properly connected and adequately secured
- Compressed air is not being supplied to an open flex block RAPID.

Start up and operation to be performed under the following conditions:

- Operations are initiated and monitored by trained personnel.
- Operation can be ceased from one side of the machine.

#### 4.3.5. IN CASE OF EMERGENCY

In case of emergency, follow these three steps:

1. Turn off the machine
2. Disconnect all power sources (compressor and power pack)
3. Call for help

#### 4.3.6. VIOLATION OF SAFETY REGULATIONS



Any violation of the safety regulations can result in serious personal injury and possible machine damage.



## 5. OVERVIEW AND APPLICATION

### 5.1. GENERAL DESCRIPTION

The machine consists of:

- Hydraulic control valve unit
- PowerFlow RAPID/MultiFlow RAPID unit:
  - Inlet with digital counter
  - Chain drive unit
  - Flex block RAPID

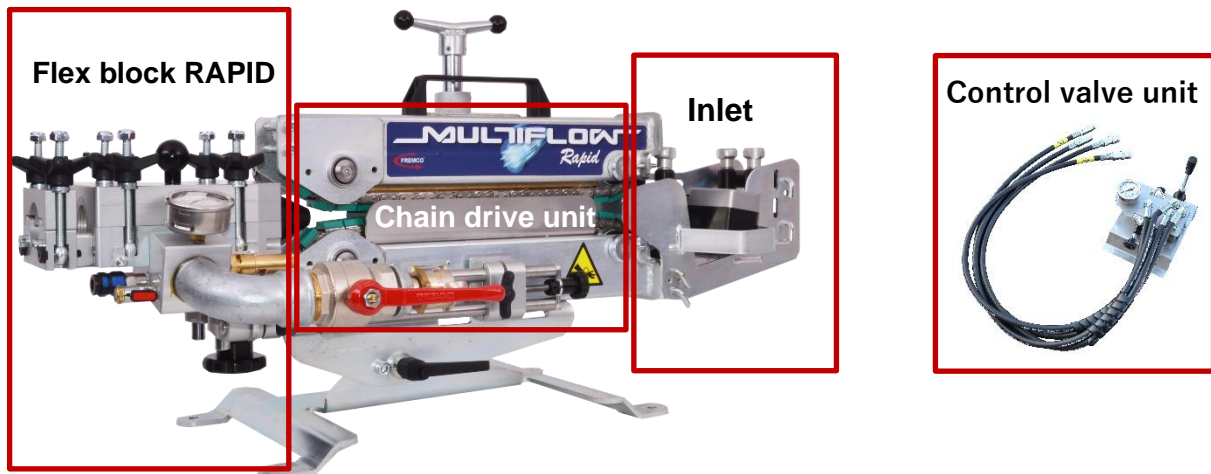

### 5.2. THE MACHINE'S PURPOSE AND INTENDED USE

The machine is constructed for blowing fiber optic cables into microducts. MultiFlow RAPID can also be used to reline multiple microducts. The machine may only be used for these exact purposes.

PowerFlow RAPID has a fiber/cable OD of 5.5-25 mm and a duct size OD of 10-63 mm\*. MultiFlow RAPID has a fiber/cable OD of 5.5-32 mm and a duct size OD of 10-63 mm\*.

Only instructed operators may operate the machine. Similarly, only qualified personnel may perform service, maintenance, and repairs on the machine.

The machine is suited for use in an outdoor environment.

Only suitable CE-marked equipment (hydraulic and pneumatic compressor) may be connected to the machine.

The machine is not to be used for any other purpose than those provided above

*\*Standard duct size OD for PowerFlow RAPID and MultiFlow RAPID: 14-60 mm.*

*Custom duct size OD for PowerFlow RAPID and MultiFlow RAPID: 10-13 mm & 61-63 mm.*

### 5.3. OPERATING POSITIONS, LOCATION AND ARRANGEMENT

The operator's workstation is located at the front of the machine, next to the control unit.

#### During maintenance and repair:

- The area adjacent to the machine should also be considered as the workstation.

#### Space requirements:

There must be sufficient space in the workplace for the operator to operate the machine unrestrictedly and comfortably.

It is recommended to maintain a space of at least 700 mm between barriers (walls, building parts. Etc.) and controls.

#### Operation and storage limits:

Ambient temperatures	-5 °C to 40 °C
Relative humidity (non-condensing)	Min. 10 % RH Max. 80 % RH

#### Service life expectancy



The machine has a minimum service life expectancy of 20 years.



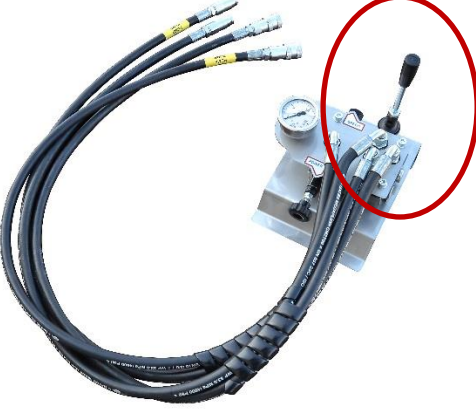

Maintenance and replacement of machine parts and safety-related components must be carried out on a routine basis.

This must be done in accordance with the operating instructions of the individual components.

## 5.4. USER INTERFACE

Below, you will find all operating handles and a short description of their use:

	<p><b>Handle for control valve</b></p> <ul style="list-style-type: none"> <li>• Provides Manometer readout of max. hydraulic oil pressure (110 BAR/1595 PSI)</li> <li>• Enables speed and torque adjustment</li> <li>• Handle moves forward/backwards</li> <li>• Attach the end of the hose with the yellow markers to the hydraulic unit.</li> </ul>
	<p><b>Air valve</b></p> <ul style="list-style-type: none"> <li>• Controls the amount of air entering the blowing chamber.</li> <li>• Picture shows the OPEN position.</li> <li>• Turn clockwise to close, turn anticlockwise to open.</li> </ul>
	<p><b>Vent valve</b></p> <ul style="list-style-type: none"> <li>• Releases air pressure from the duct and blowing chamber before opening the Flex block.</li> <li>• Picture shows the OPEN position, turn anticlockwise to close.</li> </ul>

	<p><b>Quick coupling (air/water)</b></p> <ul style="list-style-type: none"> <li>• Connects to the EU/US claw coupling for the airhose.</li> <li>• The EU (DIN 3238) claw coupling is mounted by default.</li> <li>• The US claw can be found in the box.</li> </ul>
	<p><b>Safety valve</b></p> <ul style="list-style-type: none"> <li>• Pressure relief valve. Set to release pressure above 16 BAR/230 PSI.</li> </ul>
	<p><b>Handle for spindle.</b></p> <ul style="list-style-type: none"> <li>• Rotate clockwise to move top chain down towards bottom chain.</li> <li>• Rotate anticlockwise to move top chain up and away from bottom chain.</li> </ul>
	<p><b>Manometer</b></p> <ul style="list-style-type: none"> <li>• Provides readout of current pressure in flex block RAPID.</li> <li>• Maximum pressure 16BAR/230 PSI.</li> </ul>

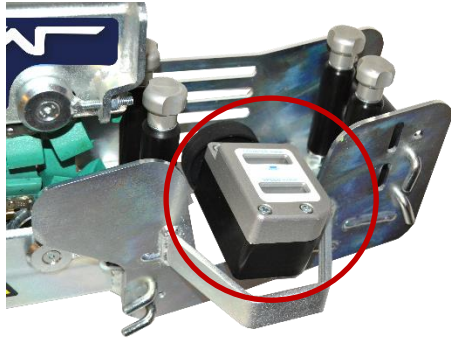

### Digital distance and speed counter

- Readout 1 shows the total length of fiber passing the counter.
- Readout 2 shows the speed of fiber passing the counter.
- Blue button resets total meter counter.

## 5.5. MACHINE ASSEMBLY AND ADJUSTMENT

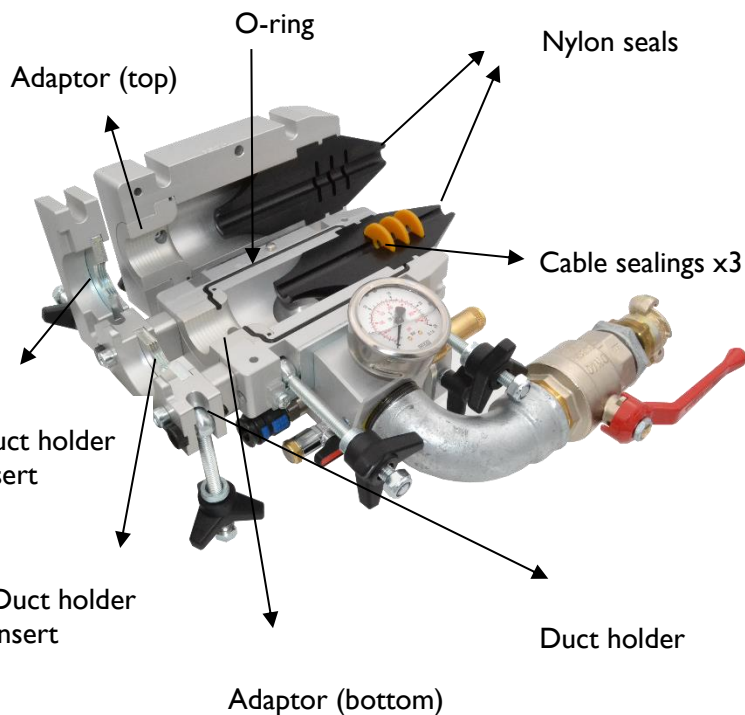

### Parts in the Flex block RAPID

Duct holder inserts and adaptors are chosen according to the duct size.

The same goes for choosing nylon sealing and cable sealings.

The O-ring should be adjusted depending on the adaptor and duct size.

1.

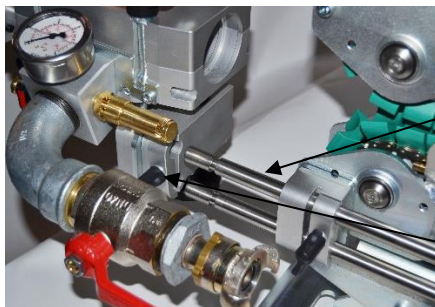

Steel bracket bars

Hand knob

2. Not mounted



3. Mounted

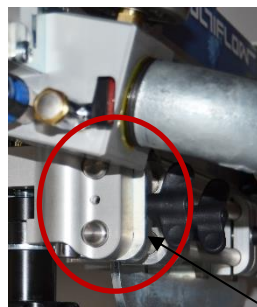

## Mounting the Flex block RAPID

Mounting the Flex block RAPID to the machine involves sliding the bottom part of the Flex block RAPID onto the steel bracket bars (Picture 1).

Slide the block onto the bars until it clicks into place, and tighten the hand knob (Picture 3).

If you have not mounted the Flex block RAPID properly, you will not be able to see the locking mechanism (Picture 2).

However, when the Flex block RAPID is mounted properly, the lock mechanism will be shown (Picture 3).

To dismount the Flex block RAPID, repeat the process backwards.

1.



2.

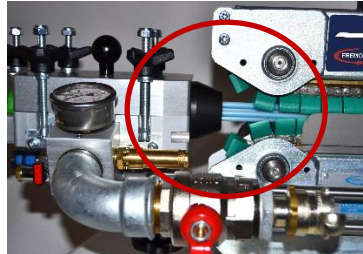

3.



4.



## Adjusting the Flex block RAPID

Before any fiber blowing job, ensure that the flex block RAPID is adjusted to the machine. You can adjust the height and length.

### Adjusting the height

Find the hand knob beneath the Flex block RAPID (Picture 1) and turn to adjust the height of the flex block RAPID until the nylon guides aligns with chains on the machine (Picture 2).

### Adjusting the length

Find the hand knob at the end of the steel bracket bars (Picture 3) and turn to adjust the length until the gap between the nylon seal and chain is as small as possible (approximately 2 mm). Make sure that the nylon guides do NOT touch the chains.

1.



2.

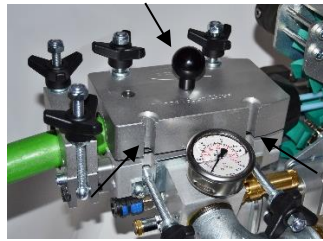

3.



4.

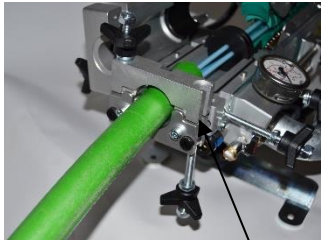

5.

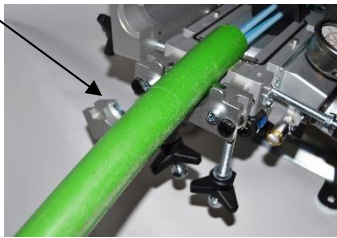

### Opening and closing the Flex block RAPID

To open the Flex block RAPID, unscrew four hand knobs (Picture 1). The two hand knobs on the operational side can now be loosened/moved away. Pull the round hand knob on top of the flex block RAPID upwards and pull away from the operational side to open the flex block RAPID (Picture 2).

Now continue with the duct holder, as shown in pictures 3, 4 & 5.

To close the Flex block RAPID, repeat the process backwards.

1. Inlet for single cable



Rollers

2. Inlet for relining



Nylon guides for microduct

### Parts in the inlet

- Adjust the rollers to centre the cable or multiple ducts.
- The digital distance and speed counter is pre-mounted on the inlet.

## 6. TRAINING

### 6.1. OPERATORS

The machine may only be operated by qualified operators. Operators must be familiar with the machine's function and safety conditions.

Operators must read and understand the operating manual, workplace instructions, etc., and understand of the machine's function and safety measures. They must also be able to perform general adjustments, etc., and be trained/instructed in the machine's use, handling etc. through reviewing the operating manual, operating instructions, and workplace instructions.

Operators must be familiar with the location of secure access ways.

### 6.2. MAINTENANCE PERSONNEL

Service, repairs, and maintenance may only be carried out by qualified maintenance personnel.

Maintenance personal must understand the machine's function and safety measures and be familiar with the location of secure access ways and emergency stops.

Maintenance personnel must have read and understood the operating manual, workplace instructions, etc.

Before commencing service or maintenance, maintenance personnel must be instructed in the machine's safety.

New maintenance personnel must be trained by an experienced colleague.



## 7. OPERATION

The information in this section is relevant for operators.

### 7.1. TRANSPORTING THE MACHINE

When transporting the machine, it is important you make sure that the machine is secure and stable throughout the entire journey. When the machine arrives at the fiber blowing site, it must be carried by two people or it must be transported in accordance to national requirements and regulations. Before initiating fiber blowing, it is important that the operator fixes the machine on e.g. a trolley or a box.

### 7.2. START/STOP

Before initiating operation, the operator must ensure that they have full visibility over the machine, and that no unnecessary personnel are in the immediate vicinity. This also means that the area must be adequately lit.

In addition, the operator must ensure that the controls and connectors are clearly and unambiguously marked in order to prevent faulty operation.

When in close proximity to machine, operators must be extra aware of the machine's movement.

### 7.3. ENERGY SUPPLY CONNECTION/DISCONNECTION



**AIR/WATER CONNECTED**

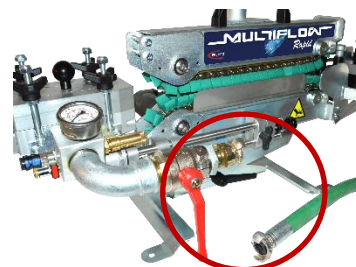

**AIR/WATER DISCONNECTED**

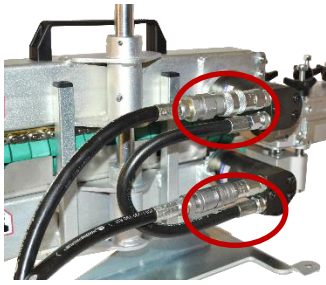

**HYDRAULICS CONNECTED**

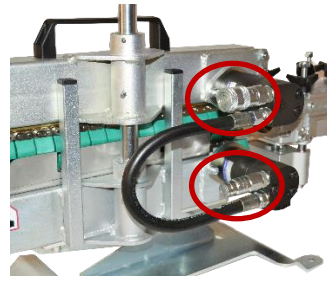

**HYDRAULICS DISCONNECTED**



When looking at the control valve it is marked on the sticker how to make the fiber/cable go forward and reverse.

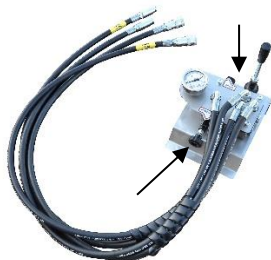

Use the hand knobs to adjust the maximal speed. Turning the hand knob clockwise decreases the speed and torque. Turning the knobs counterclockwise increases the maximum speed and torque.

## 7.4. FEEDING/REMOVING PRODUCTS

The operator manually feeds the machine with a fiber optic cable, by passing it through the inlets, chain drive and Flex block RAPID before turning on the machine.

After the fiber blowing has been completed, the fiber optic cable is manually removed from the machine.

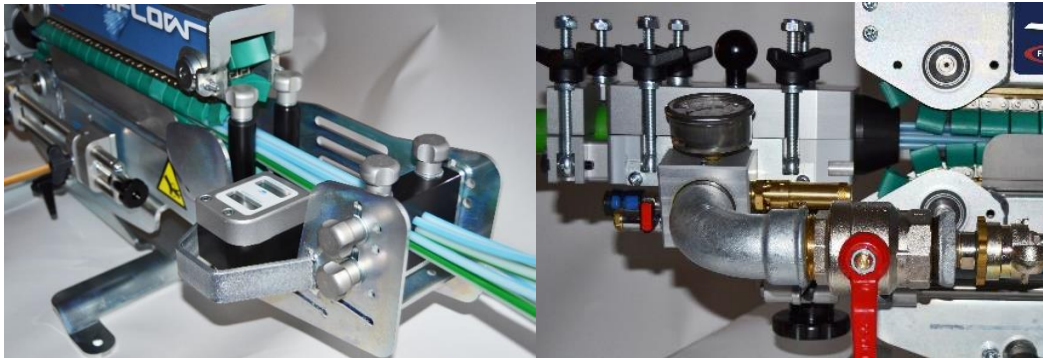

## 7.5. AIR/WATER SUPPLY

To apply air or water to the machine and Flex block RAPID, gradually turn the air valve on. Never supply compressed air/water to an open Flex block RAPID.



**AIR ON**

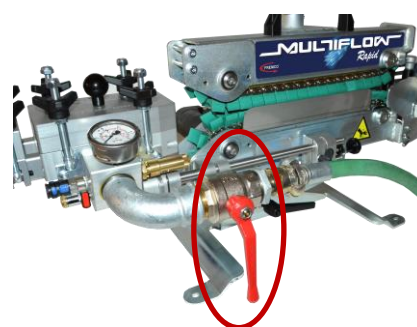

**AIR CLOSED**

## 8. MAINTENANCE, TROUBLESHOOTING AND REPAIR

The information in this section is relevant for maintenance personnel.

### 8.1. QUICK GUIDE TO MAINTENANCE, TROUBLESHOOTING AND REPAIR

Before repair, maintenance, etc. commences, disconnect (lock) and vent or depressurize energy sources.

- Disconnect and vent/depressurize pneumatics and hydraulics
- Do not reconnect the supply until the maintenance work is complete  
*This prevents accidental start-up of the machine*
- Always use suitable PPE when performing repair or maintenance work
- If additional light is needed, maintenance personnel must obtain this before starting work
- Personnel must exercise extra caution when the machine is in operation if they have disassembled the machine or are handling spare parts or tools
- Following completion of maintenance or repair, the operator must check if the machine is operational.

### 8.2. PREPARATION FOR MAINTENANCE AND REPAIR

#### 8.2.1. CLEANING

Maintenance personnel must be aware of the location of potential hidden hazards before the work commences.

During cleaning, the machine must be switched off (disconnected from energy supply), and PPE must be used in accordance with the data sheets for the product in question.

Operators must keep the area adjacent to the machine clear of people and objects that may cause operators to slip and fall or to get tangled and caught in the machine.

#### 8.2.2. CORRECTIVE MAINTENANCE

If the machine produces noise, unusual vibrations, etc., locate the fault and rectify it. If this is not possible, contact maintenance personnel.

Parts and components should only be replaced with original parts by the manufacturer.



All written information and warnings must be formulated in the official community language. In the case of unreadable or indistinct information and warnings, these must be immediately replaced with new ones.

### 8.2.3. REPAIR

Maintenance personnel must be informed of the location of potential hidden hazards before the work commences.

Before commencing any repair or maintenance work the machine must be disconnected and vented from the pneumatic and hydraulic.

This is to prevent unintentional start-up of the machine. Machine personnel must never operate the machine if they have disassembled the machine or are handling spare parts or tools.

## 8.3. SERVICE AND REPAIR ADDRESS

In the case of defects or need for repairs covered by warranty, please contact either the designated reseller in your country or Fremco for help.

Company name: Fremco A/S  
Address: Ellehammervej 14,  
DK-9900 Frederikshavn,  
Denmark  
Telephone: +45 72 30 12 13

## 8.4. DISCONNECTION AND DEPRESSURIZATION OF ENERGY SOURCES

Before disconnecting energy sources, the systems should be depressurized

- Stop compressor and hydraulic Power Pack
- Depressurise the hydraulic system by moving the hydraulic control unit joystick forwards and backwards two times (this may make the machine's chains move a little)
- Depressurise the pneumatic system by opening the vent valve on the flex block RAPID and then slowly opening the main air valve until all air has been vented out
- Check on the manometer and control valve that there is no pressure left. Now, disconnect the hydraulic and pneumatic quick couplings.



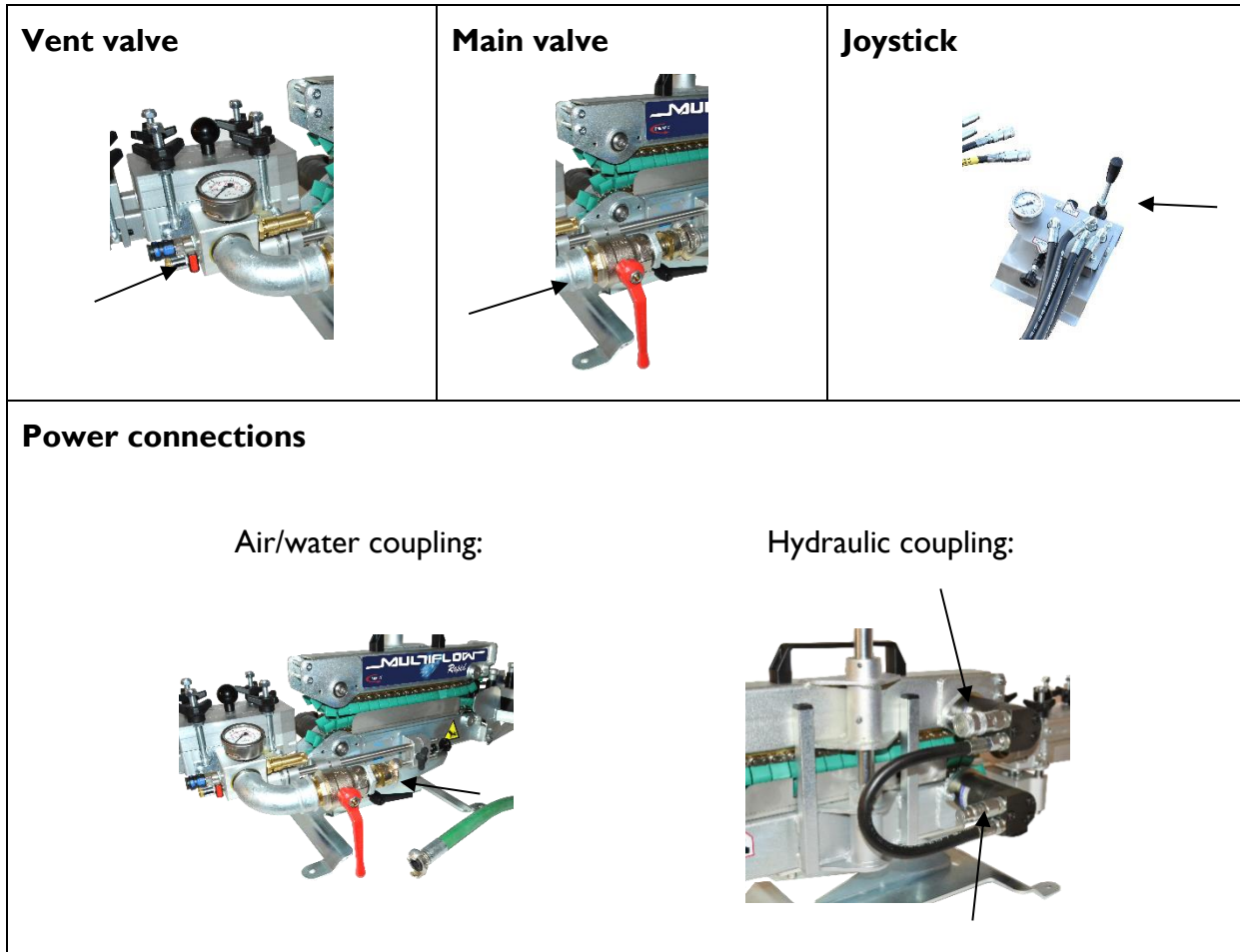

## 8.5. MAINTENANCE SCHEDULE

Below, you will find the daily, weekly, monthly and annual inspection and maintenance schedule. If wear and tear parts are defective or worn to an extent that is unacceptable, these parts should be replaced/fixed before continued use.

Daily inspection and maintenance		
Daily inspection and maintenance must be performed by a trained operator, before startup and with energy sources disconnected (quick couplings)		
#	Task	Instructions
1	Check that pressure bearing hydraulic parts are undamaged	Visual inspection
2	Check that pressure-bearing pneumatic parts are undamaged	Visual inspection

4	Check that mechanical parts, including guards, are undamaged and correctly mounted	Visual inspection
5	Check that warning signs are intact	Visual inspection
6	Check that the chain is intact and undamaged	Visual inspection
7	Perform daily cleaning tasks	Brush with a stiff brush (not a steel brush) and wipe with a slightly damp cloth, possibly using a mild detergent
<b>PPE for inspection and maintenance</b>		
*	Gloves for protection against hydraulic fluids and lubricating oil	
*	Protective glasses	
*	Protective shoes	

<b>Weekly inspection and maintenance</b>		
Weekly inspection and maintenance must be performed by a trained operator before startup and with energy sources disconnected (quick couplings)		
#	Task	Instructions
1	Ensure the chains and chain support rail are sufficiently lubricated	See description: 7.5.3. <i>Lubrication of the chains and chain support rail.</i>
2	Check the chain adjustment	See description: 7.5.4. <i>Chain adjustment</i>
3	Check the gaskets	Inspect for visible signs of wear. Replace any parts in the case of excessive wear
<b>PPE for inspection and maintenance</b>		
*	Gloves for protection against hydraulic fluids and lubricating oil	
*	Protective glasses	
*	Protective shoes	

<b>Monthly inspection and maintenance</b>		
Monthly inspection and maintenance must be performed by a trained operator before startup and with energy sources disconnected (quick couplings)		
#	Task	Instructions
1	Ensure the spindle and 2 pcs. of nipples are sufficiently lubricated	See description: 7.5.6 <i>Spindle lubrication</i>
2	Check the chain support rails	See description: 7.5.2 <i>Chain support rail</i>
3	Check the chains and sprockets	See description: 7.5.5. <i>Chains and sprocket wear</i>
4	Check the format parts	Inspect for visible signs of wear. Replace any parts in case of excessive wear

5	Monthly cleaning	Brush with a stiff brush (not a steel brush) and wipe with a slightly damp cloth, possibly using a mild detergent. Wipe the chain support rail, chains, and sprockets clean of lubricant residues, using a suitable cleaning agent (with the chains removed)
<b>PPE for inspection and maintenance</b>		
*	Gloves for protection against hydraulic fluids and lubricating oil	
*	Protective glasses	
*	Protective shoes	

<b>Annual inspection and maintenance</b>		
Annual inspection and maintenance must be performed by Fremco or another qualified service partner before startup and with energy sources disconnected (quick couplings)		
#	<b>Task</b>	<b>Instructions</b>
1	Check the safety functions	Ensure that the hold-to-run function works as intended and the machine stops when the control valve is released
2	Check the pressure gauge	Check the pressure gauge for accuracy
3	Check the air pressure relief valve	Ensure the air pressure relief valve functions as it should
<b>PPE for inspection and maintenance</b>		
*	Gloves for protection against hydraulic fluids and lubricating oil	
*	Protective glasses	
*	Protective shoes	

### 8.5.1. VISUAL INSPECTION

If any components are visibly worn, damaged and/or incorrectly mounted, this must be rectified before the machine is operated.

### 8.5.2. CHAIN SUPPORT RAIL

The chain support rail must be replaced in case of one of the following wear indicators:

- The rail is worn to 8.5 mm
- The distance between the chain and chain support rail reaches a minimum of 1 mm



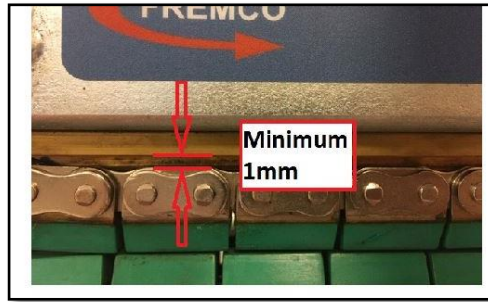
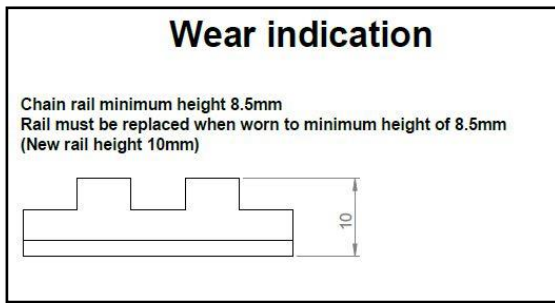

### 8.5.3. LUBRICATION OF THE CHAINS AND CHAIN SUPPORT RAIL

Chains are lubricated using a suitable chain lube spray.

Spray a thin coat of chain lube between the chain and chain support rail, along the full length of the support rail and on both sides of chains (top and bottom).



### 8.5.4. CHAIN ADJUSTMENT

Adjust the chains using the two sets of chain tensioning screws. The chain has been tightened correctly when it can be lifted 2-3 mm from the chain support rail with two fingers (see picture below). This test should be performed in the middle of the machine. When adjusting the chain, remember to tighten the screws evenly to ensure that the shaft is perpendicular to the chain and chain support rail.

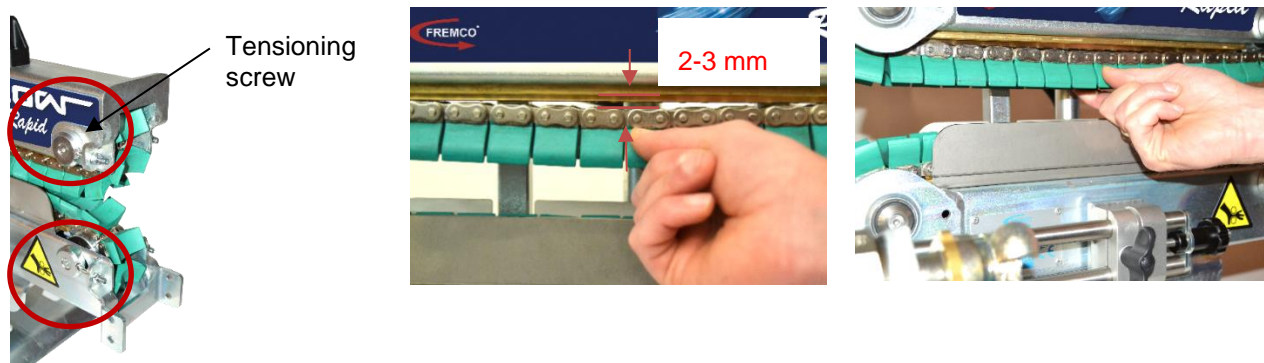

### 8.5.5. CHAINS AND SPROCKET WEAR

Visually inspect the chains and sprockets for any wear. If the wear exceeds what is reasonable, the chains and sprockets must be replaced.

Indications of worn chains and sprockets:

- The chains have clear and deep wear marks from the chain support rail
- The rubber on the chains have large deformations on the front and back edges due to wear
- The chain teeth of the sprockets are clearly and visibly deformed

It is always recommended to replace the chain and sprockets together with chain support rail.

Pictures of chains and chain parts that exceed reasonable wear:

Chains:

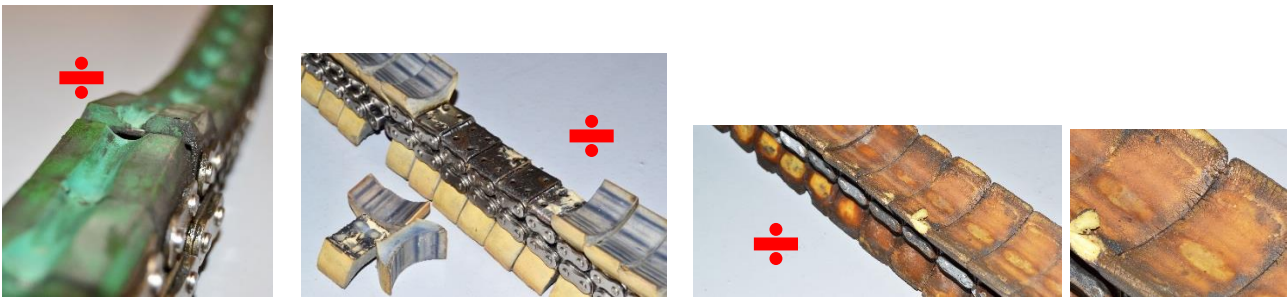

Support rails

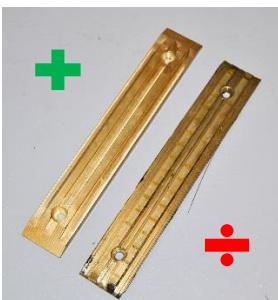

Sprockets



### 8.5.6. SPINDLE LUBRICATION

Lubricate the spindle with multipurpose grease.

- To start, screw the spindle handle all the way up to expose the threads, and lift it off. Now, brush a light coat of grease onto the threads before screwing the spindle handle down again

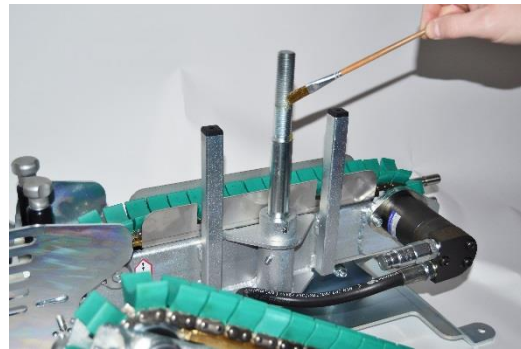
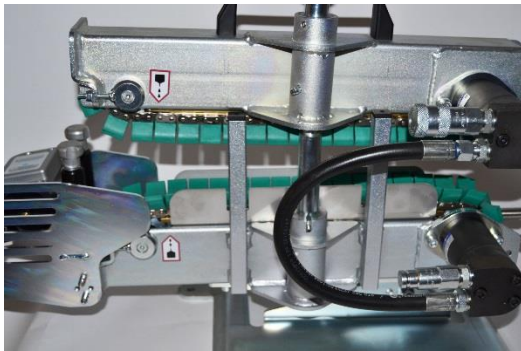



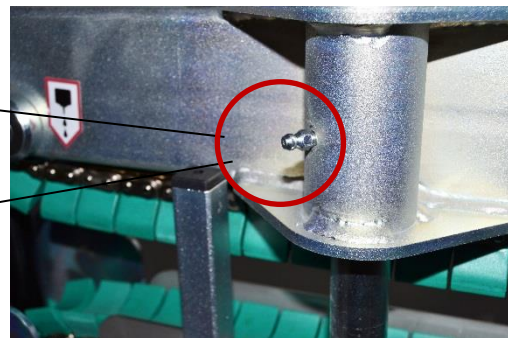
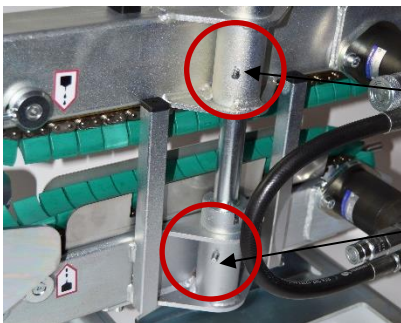

- Pump grease into the two grease nipples using a suitable grease gun. Use one or two pumps for each nipple

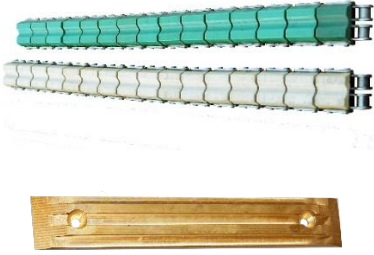

- Finish by wiping all excessive grease off the machine

### 8.6. WEAR AND TEAR PARTS

The list below is an overview of wear and tear parts for the machine. It is important to replace wear and tear parts when they are no longer viable for use. This should be checked during the daily, weekly, monthly, or annual inspection and maintenance of the machine.

	<p><u>Cable sealings</u></p> <p>Cable sealings are available in multiple sizes. Wear and tear parts can be ordered through the designated reseller in your country.</p>
	<p><u>Chains and support rails</u></p> <p>The chain and support rails are available in multiple sizes. Wear and tear parts can be ordered through the designated reseller in your country.</p>
	<p><u>Nylon seals</u></p> <p>Nylon seals come are available in multiple sizes. Wear and tear parts can be ordered through the designated reseller in your country.</p>
	<p><u>Air/water-tight plug for microducts</u></p> <p>This part is used for relining with the MultiFlow RAPID Relining, and is available in multiple sizes. Wear and tear parts can be ordered through the designated reseller in your country.</p>
	<p><u>Valve for microduct</u></p> <p>This part is used for relining with the MultiFlow RAPID Relining, and is available in multiple sizes. Wear and tear parts can be ordered through the designated reseller in your country.</p>

## 9. BLOWING TECHNIQUE

The information in this section is relevant for operators.

### 9.1. BEFORE FIBER BLOWING

1. Check the compressor air levels. It is important to have enough air (at least 10 bar)\*

PowerFlow RAPID & MultiFlow RAPID

- Airflow: 8000-12000 l/min
- Pressure: 8-12 bar

*\*Never exceed the recommended air pressure*

2. Take note of the distance marking on the fiber/cable.
3. Do not use a fiber/cable that fill the duct to exceed 70-75% capacity

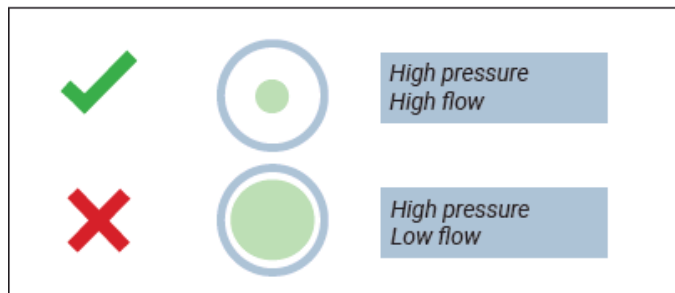

### 9.2. PREPARING THE DUCTS FOR FIBER BLOWING

#### 1. Cleaning the duct

1. Apply one or multiple sponges in the duct.
2. Add air pressure and blow sponge.
3. Make sure the sponge arrives at the other end of the duct.
4. Check that the sponge looks clean after it arrives at the other end - or repeat with new sponges until its clean.

## 2. Perform a pressure test

Perform a pressure test by blocking the duct at the opposite end and applying max. 10 bar of air pressure. Check for pressure loss. The duct should be able to hold the pressure for a minimum of 5 minutes.

### 9.3. INITIATING FIBER BLOWING

#### 1. Lubricating the duct

1. Apply one sponge at the desired depth (See guideline on FlowLUB).
2. Add desired amount of FlowLUB
3. Apply one more sponge (creating three layers with sponges and lubrication)
4. Add air pressure pushing sponges and FlowLUB all the way through to the end

#### 2. Remember the airflow principle

Start the fiber blowing installation according to the airflow principle

- A) Start feeding the cable into duct without applying air.
- B) Check with your hand that you can hold/stop the cable at all times.

This should make the wheel/chain spin while the cable is not moving.

- C) Apply the air in  $\frac{1}{4}$  amounts as the speed is decrease. Reduce speed in all cases of obstacles during full airflow.

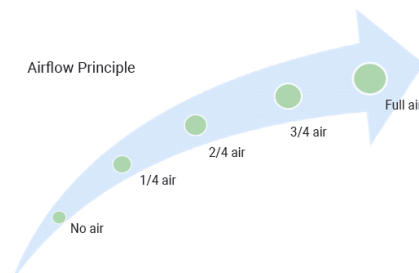

## 10. CESSATION OF USE

### 10.1. DISMANTLING

Before dismantling the machine, a plan must be prepared detailing this purpose. The plan must include a risk assessment for the work as well as for the disposal of machines and machine parts.

### 10.2. SCRAPPING

The machine must not be disposed of as unsorted household waste. Use the local WEEE collection points to dispose the machine and make sure that all relevant provisions are complied with.

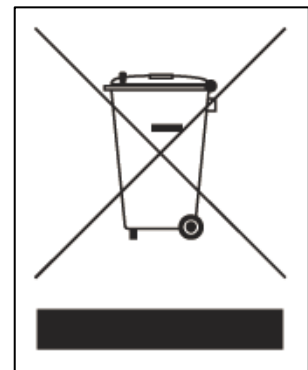

# 11. EC DECLARATION OF CONFORMITY

## Manufacturer:

Fremco A/S  
 Ellehammervej 14  
 DK-9900 Frederikshavn  
 Denmark

We hereby declare that

101-40021 MultiFlow RAPID for single cable & 101-40002 MultiFlow RAPID for relining  
 & 101-40001 PowerFlow RAPID  
 From serial No. 9328.3649 (PowerFlow RAPID) & 9328.3748 (MultiFlow RAPID)

is manufactured in conformity with the EC Directives

### EC Directives:

**2006/42/EC** – the Machinery Directive

The directive has the dual aim of harmonising the health and safety requirements applicable to machinery on the basis of a high level of protection of health and safety, while ensuring the free circulation of machinery on the EU market.

### International standards:

**DS/EN ISO 12100:2011** - Safety of machinery

The standard specifies basic terminology, principles and a methodology for achieving safety in the design of machinery. It specifies principles of risk assessment and risk reduction to help designers in achieving this objective

### European standards:

**DS/EN ISO 4414:2010** - Pneumatic fluid power

ISO 4414:2010 deals with all significant hazards associated with pneumatic fluid power systems and specifies principles to apply in order to avoid those hazards when the systems are put to their intended use.

**DS/EN ISO 4413:2010** - Hydraulic fluid power

ISO 4413:2010 deals with all significant hazards associated with hydraulic fluid power systems and specifies the principles to apply in order to avoid those hazards when the systems are put to their intended use.

### Technical file responsible:

Kasper Mikkelsen  
 Research & Development Manager  
 Ellehammervej 14, DK-9900 Frederikshavn

### Attested by:



Kim Lindblad Carlsen  
 Managing Director  
 Frederikshavn, 01.01.2021



Kasper Mikkelsen  
 R&D Manager  
 Frederikshavn, 01.07.2021



## 12. UKCA DECLARATION OF CONFORMITY

### Manufacturer:

Fremco A/S  
 Ellehammervej 14  
 DK-9900 Frederikshavn  
 Denmark

We hereby declare that

101-40021 MultiFlow RAPID for single cable & 101-40002 MultiFlow RAPID for relining  
 & 101-40001 PowerFlow RAPID  
 From serial No. 9328.3649 (PowerFlow RAPID) & 9328.3748 (MultiFlow RAPID)

Is manufactured in conformity with

### UK Directives:

**2008 No. 1597** – Supply of Machine (safety) regulations 2008

The purpose of the legislation is to ensure safe machinery is placed on the market or put into service by requiring manufacturers to show how their machinery meet the 'essential health and safety requirements'

### International standards:

**DS/EN ISO 12100:2011** - Safety of machinery

The standard specifies basic terminology, principles and a methodology for achieving safety in the design of machinery. It specifies principles of risk assessment and risk reduction to help designers in achieving this objective

### European standards:

**DS/EN ISO 4414:2010** - Pneumatic fluid power

ISO 4414:2010 deals with all significant hazards associated with pneumatic fluid power systems and specifies principles to apply in order to avoid those hazards when the systems are put to their intended use.

**DS/EN ISO 4413:2010** - Hydraulic fluid power

ISO 4413:2010 deals with all significant hazards associated with hydraulic fluid power systems and specifies the principles to apply in order to avoid those hazards when the systems are put to their intended use.

### Technical file responsible:

Kasper Mikkelsen  
 Research & Development Manager  
 Ellehammervej 14, DK-9900 Frederikshavn

### Attested by:



Kim Lindblad Carlsen  
 Managing Director

Frederikshavn, 01.07.2021



Kasper Mikkelsen  
 R&D Manager

Frederikshavn, 01.07.2021



## 13. APPENDICES

### 13.1. HYDRAULICS SCHEMATICS

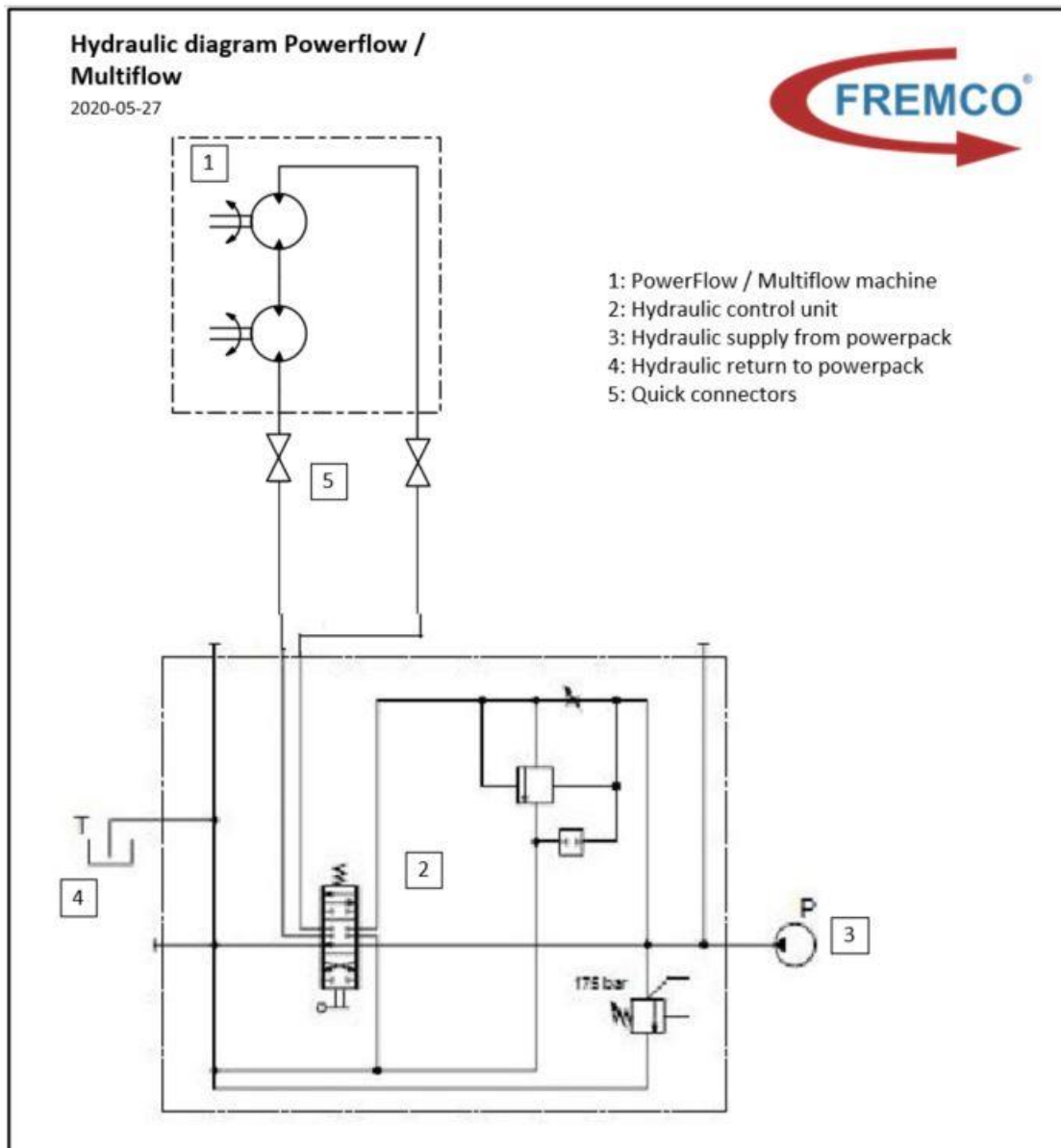

## 13.2. PNEUMATICS SCHEMATICS

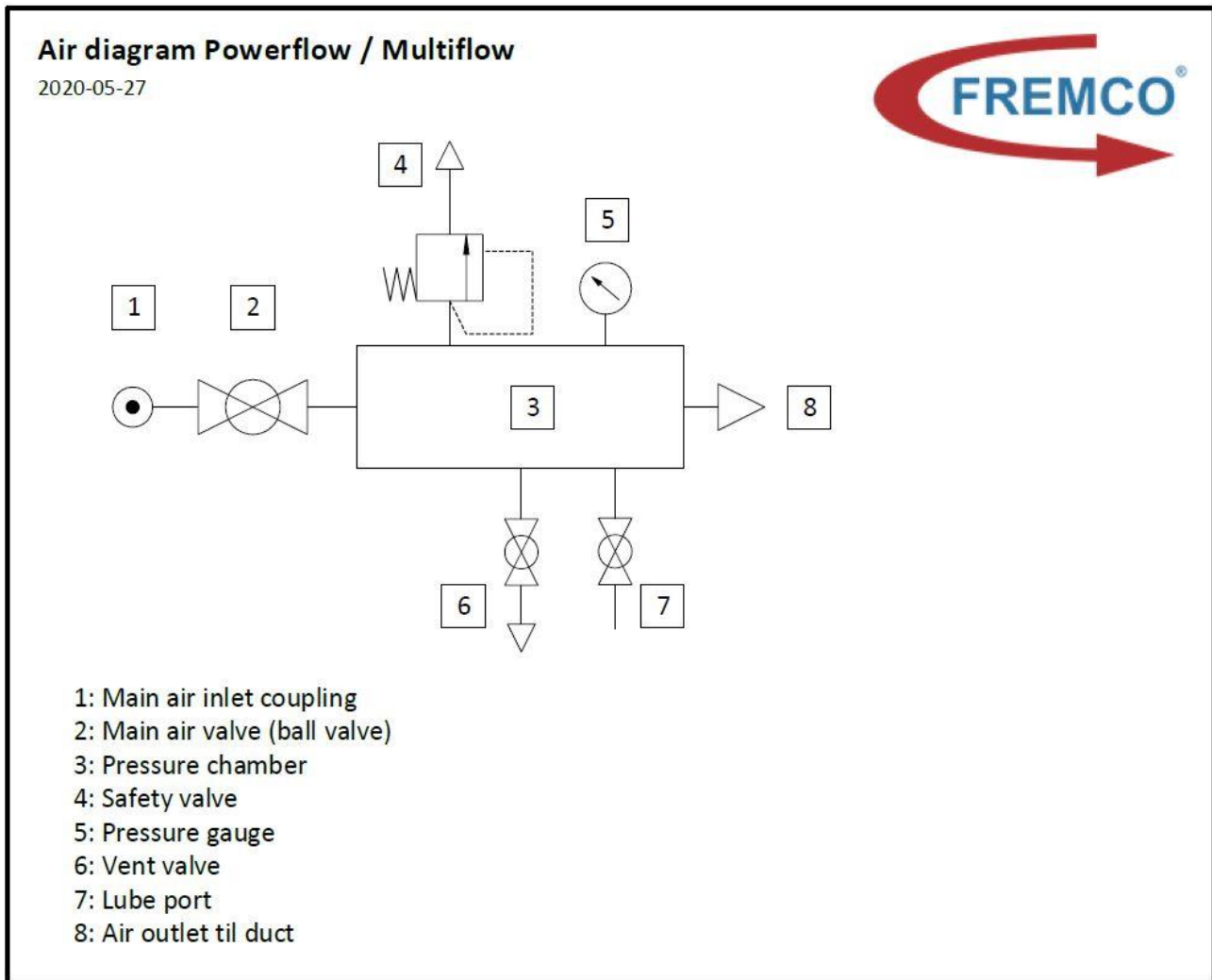

### 13.3. DRAWINGS OF MECHANICAL CONSTRUCTION

DRAWING: Last change for JK

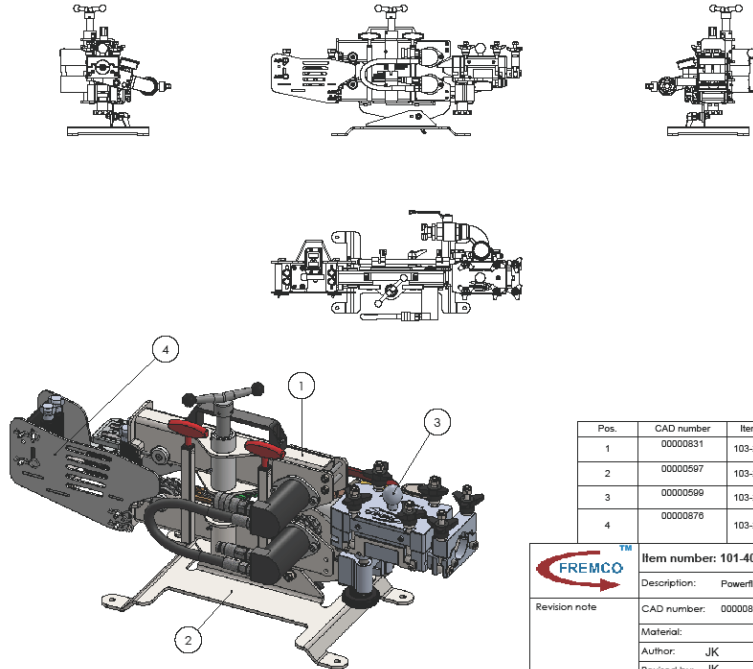

Pos.	CAD number	Item number	Description	QTY.
1	00000831	103-200210100	Powerflow machine for 2nd Gen flex, no base, unconfigured	1
2	00000597	103-200210030	Flex block 2nd Gen. mounting bracket ass. Powerflow	1
3	00000599	103-200210001	Flex block 2nd gen. ass.	1
4	00000876	103-200317003	Meter counter FLEX Ass. 2nd Gen Single cable	1

		<b>Item number: 101-40001</b>	
Description: Powerflow 2nd Gen.Fremco metric		page	1 of 2
CAD number: 00000874		revision 002	
Material:		scale 1:1	
Author: JK		created date 2020-03-17	
Revised by: JK		revised date 2020-03-23	

COPYRIGHT © 20-03-2020 BY FREMCO